



**OUR TECHNOLOGY  
YOUR SKILL**



**LAPAROSCOPY  
2014**



Our combined competences in medical endoscopy systems provide global solutions. From now on, SOPRO-COMEG forms the ideal leader with second-to-none "know-how": SOPRO in medical video imaging and COMEG in engineering endoscopy and micro lenses. Since many years, the product lines of SOPRO and COMEG have been setting the standards for image management systems with fully proven quality, efficiency, safety and convenience.

Our goal is to provide the safest and most advanced products and technologies that ensure reliable operating procedures and rapid recovery.

Synergy between our R&D Departments will result in products and systems that offer added clinical benefits and meet the requirements of patients, surgeons and the health care system even more effectively.

Engineers, mechanics, sales representatives... all our staff has one thing in common: their enthusiasm for hard work to serve our customers.



SOPRO  
COMEG

*SOPRO-COMEG offers a complete range of re-usable, high quality, durable instruments for entry into the iperitoneumi; the first and most crucial step in successful laparoscopic surgery. SOPRO-COMEG also offers a complete range of hand instruments in both monopolar and bipolar electrocautery versions.*

<b>1</b>	Company . . . . .page 5
<b>2</b>	Optics . . . . . page 11
<b>3</b>	Trocars . . . . . page 23
<b>4</b>	Dissecting and grasping forceps . . . . . page 39
<b>5</b>	Scissors, biopsy forceps . . . . . page 69
<b>6</b>	Instruments for coagulation . . . . . page 81
<b>7</b>	Accessories . . . . . page 93
<b>8</b>	Suture and ligature . . . . . page 99
<b>9</b>	Sterilization and maintenance . . . . . page 105

Company

Optics

Trocars

Dissecting and  
grasping forceps

Scissors  
biopsy forceps

Instruments for  
coagulation

Accessories

Suture and  
ligature

Sterilization and  
maintenance

French manufacturing plant

**La Ciotat - FRANCE**

Surface : 3 200 m<sup>2</sup>



German manufacturing plant

**Tuttlingen - GERMANY**

Surface : 2 600 m<sup>2</sup>

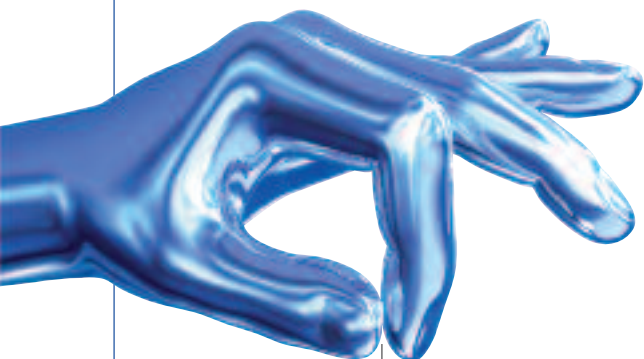

## **1 • COMPANY**

Company history . . . . .	p6
Products range at a glance . . . . .	p7
Regulatory . . . . .	p8
Research & Development . . . . .	p9
Service & Assistance . . . . .	p9
Representative offices . . . . .	p9

## Company history



**1977**

SOPRO was founded.

**1986**

Introduction of microcameras for endoscopy.

**2001**

SOPRO joins the Acteon Group.

**2003**

Sopro moves into a bigger, brand new building in La Ciotat.

**2004**

Acquisition of Geyser and development of a range of insufflators and pumps.



**1975**

COMEG was founded.

**1977**

Introduction of medical endoscopes.

**1993**

Introduction of autoclavable endoscopes.

**1994**

Introduction of the urology product line.

**2001**

New optical generation of medical endoscopes.



**2006**

COMEG joins SOPRO

**2007**

Introduction of a Spine surgery product line

**2009**

Introduction of the Digilap Titanium, autoclavable videolaparoscope

Introduction of the SOPRO 397 3CCD Full HD camera

Introduction of the Sopro Medical Software

Introduction of a range of bipolar forceps & scissors

**2010**

Introduction of the Full HD laparoscope

Introduction of HEOS, the hysteroscopic endo operative system

Introduction of UBIPACK, the complete solution for gynecology and ENT

**2011**

Introduction of ULYSS, 4mm autoclavable endoscope with variable direction of view

**2012**

New range of uretero-renoscopes

**2013**

Introduction of a bipolar resectoscopy range

**Products range at a glance**



**SOPRO-COMEG offers a complete range ranking from capital equipment to re-usable, high quality, durable instruments. Whatever your application is: Urology, Laparoscopy, Arthroscopy, Gynecology, Spine, ENT, SOPRO-COMEG will offer you the best solution and fulfill your needs.**

**Capital equipment**

SOPRO-COMEG meets the needs of the surgeons and distributors by supplying the complete OR trolley. Our range includes video cameras ranking from 1 CCD to 3CCD Full HD, Xenon and LED light sources, insufflators, pump, shaver, medical grade monitor and archiving systems. These products already met a large worldwide success with the unmatched image quality they offer.

SOPRO-COMEG proposes a complete range of instruments for entry into the peritoneum, the first and most crucial step in successful laparoscopic surgery. A complete range of hand instruments in both monopolar and bipolar electrocautery versions is also available. The full HD 10mm laparoscope will provide you the quality you need for High Definition picture.

**Laparoscopy**



**Urology**

SOPRO-COMEG, a company with over 25 years experience in the urology field, offers endoscopes with exceptional optical quality and a complement of instruments which will ease even the most demanding urological procedures including: cystoscopy, resectoscopy and urethrotomy. These products are an integral part of recent technological advancements which improve the diagnosis-treatment process and the level of care that urologists can now offer to their patients.

**Gynecology**

Gynecology, hysteroscopy, resectoscopy and other procedures are made easier with the SOPRO-COMEG products. Clarity and efficiency are the key words of our gynecology range.



**Arthroscopy**



Sharp images, precision in visualization are possible through the use of our range for arthroscopy from 4.0mm telescopes to the small-joint arthroscopic lines.

**Spine**

Our spinal endoscopy system allows to treat disc-diseases. All types of hernias can be removed in a minimal invasive interlamiar approach, by means of the endoscopic technique. The technique also qualifies for the effective treatment of chronic back-ailments caused by disc-prolaps or tears. Furthermore, endoscopic treatment of spinal stenosis has increased.



**ENT**



Our field of activities also includes all areas of the ENT disciplines, whether it is diagnostics or therapy, practice or clinic. We propose rigid endoscopes and accessories necessary for sinuscopy, otoscopy and laryngoscopy. All our instruments are manufactured with the highest quality materials.



## Regulatory

**Our business practices and processes are designed to achieve quality results that exceed the expectations of patients, customers, surgeons. We are dedicated to the delivery of quality healthcare products around the world.**

From the start of development of a new device through manufacturing to the final quality control check before delivery, Quality is built in to all our products, as is our commitment and dedication to our customers throughout the world.

Both plants are certified to the highest international quality standard, ISO 13485 for Design, Manufacturing and Sales. Our products comply with the various regulations established across the world, specifically those required by the Food and Drugs Administration and the European Union.

### SOPRO and SOPRO-COMEG manufactures equipments and endoscopes in accordance with the following directives or standards:

- Medical device directive 93/42 EEC (M5 2007/47 EEC)
- DIN EN ISO 13485 : 2003 AC:2007 certified : Quality management system
- EN ISO 13485: 2003 AC:2007 certified Quality management system
- EN ISO 13485: 2003 AC:2007 certified Quality management system (issued according to CMDCAS program requirements)
- Series of standards IEC 60601
- Series of standards ISO 8600
- FDA regulations\* (FDA Quality system Regulation 21 CFR Part 820).
- EC attestations issued for all our class II devices..



\*the newest ones may be 510(k) pending.



## Research & Development

Innovation being the key to improve health, SOPRO-COMEG invests a significant part of its revenue in R&D and patents filing. Our key know-how is Medical imaging with a combination of young & experimented engineers focused on Electronics, Software, Optics and Mechanics.

Also, we in SOPRO-COMEG, have access to the very wide R&D department and connections of our mother company, Acteon group, adding to the previous know-how : ultrasounds, chemical, motors, X-Ray and Cone Beam Computer Tomography systems (CBCT).

This very rare combination of know-how allows us to join the extremely limited group of the companies mastering the design & the manufacturing of the complete endoscopy solution.

## Service & Assistance

**In both our main plants (La Ciotat and Tuttlingen), our on-site specialists are dedicated to servicing and providing expertises to your SOPRO-COMEG products:**

- Express repair of all our products under warranty
- Free quotation for all repairs out of warranty
- Qualified repair with original spare parts
- Streamline endoscope exchange program
- Technical training

• **SOPRO-COMEG**  
(Equipment)  
ZAC Athelia 4  
Avenue des Génévriers  
13705 La Ciotat cedex  
France  
Tel +33(0)442 98 01 09  
cs@sopro-comeg.com

• **SOPRO-COMEG GmbH**  
(Endoscopes and accessories)  
Serviceabteilung  
Dornierstrasse 55  
78532 Tuttlingen  
Germany  
Tel +49 (0) 7461-9344-26  
claudia.mirci@sopro-comeg.com

## Representative offices

**Our local staff will support you, wherever you are in the world.**

• **SOPRO-COMEG China**  
Office 401  
No.12 Xinyuanxili Zhong Street,  
Chaoyang District, Beijing 100027  
P.R China  
Tel +86 10 646 57011/2/3  
info.cn@sopro-comeg.com

• **SOPRO-COMEG USA**  
124 Gaither Drive, Suite 140  
Mount Laurel, NJ 08054  
USA  
Tel +1 856 222 9988  
info.us@sopro-comeg.com

• **SOPRO-COMEG Taiwan**  
14F.-1, N°433, Jingping Rd.  
Jhonghe City - Taipei County 235  
Taiwan (R.O.C.)  
Tel +866 926 704 505  
tina.chu@tw.acteongroup.com

• **SOPRO-COMEG Middle East**  
Numan center 1st Floor N°111  
Gardens street  
PO box 468 - 11953 Amman  
Jordan  
Tel +962 6 553 4401  
info.me@sopro-comeg.com

• **SOPRO-COMEG Russia**  
Valdayskiy Proezd 16  
Office 243  
125445 Moscow  
Russia  
Tel + 7 499 76 71 316  
info.ru@sopro-comeg.com

• **SOPRO-COMEG India**  
B-94 G.I.D.C ELECTRONIC ESTATE  
Sector 25  
Gandhinagar - Gujarat - 382023 India  
Tel +91 (79) 2328 7473  
Fax +91 (79) 2328 7480  
qjay.sadana@in.acteongroup.com

The logo features two curved, swoosh-like shapes. The top swoosh is light green and curves from the right side towards the center. The bottom swoosh is light blue and curves from the left side towards the center. The text 'SOPRO' and 'COMEG' is centered between these two swooshes.

**SOPRO**  
**COMEG**



## 2 • OPTICS

SOPRO-COMEG optics .....	p12
Streamline Exchange Program .....	p13
General information .....	p14
Telescopes .....	p15

## SOPRO-COMEG Optics



**With more than 30 years as well known manufacturer, SOPRO-COMEG develops its own endoscopes in Tuttlingen (Germany) with the best and latest technology know-how.**

- **Stainless steel tubes:**

Choice of stainless steel tubes is done to ensure optimal quality and solidity by using European quality stainless steels. Our mechanical manufacturing department is making all cutting, polishing, finishing steps to provide you the optimal devices quality and to offer better resistance to disinfection chemical agent.

- **Rod lenses, objective and ocular:**

Since several years, SOPRO-COMEG research and development department does optical calculation to optimized parameters of brightness, contrast and resolution according to the intended use of the endoscope.

Sizes, designs, optical coatings, raw materials, all are precisely chosen by our engineers to achieve the quality you need.

By using the well-known **rod lenses** design and added **multi coating** on each interfaces, the SOPRO-COMEG endoscope offers you the best of the know-how in medical endoscope manufacturers.

During assembly process, the complete optical system is optimized with ocular and objective to achieve the requirements of quality.

Our SOPRO-COMEG Full HD laparoscope is able to provide a constant **high resolution** picture full screen in order to complete your Full HD video chain.



- **Light fibers** are selected and calculated to provide maximum light in the operating field. Our internal manufacturing

process permits to position the fibers in order to illuminate in the same direction as the direction of view of your endoscope. Endoscope light fibers can easily be connected to many of existing light cable and all our endoscope are delivered with light cable adapters (Karl Storz, Olympus, Richard Wolf, ACMI).

- **Cleaning, disinfection, sterilization and reliability** are ones of the most important requirements of today endoscopes.

Thanks to our **laser welding** technology and our validated manufacturing processes, SOPRO-COMEG offers a constant assembly quality. The use of distal and proximal **sapphire window** avoids many scratches on the optical system and the tightness of the optical system is done with patented process using valuable raw materials. With this high technology, SOPRO-COMEG endoscopes are warranty autoclavable up to 134°C during 20 minutes, double fore-vacuum.

Cleaning disinfection and sterilization processes are validated by external laboratory to ensure the respect of quality requirements.

Our SOPRO-COMEG endoscopes can be clean manually or with automatic machines as defined in our user manual. SOPRO-COMEG endoscopes are compatible with the following sterilization methods:

- Steris TM
- Sterrad
- Vapor sterilization
- EtO
- Cidex
- Henkel-Ecolab Sekumatic FRE

## Streamline Exchange Program

Efficiency and reactivity are the main goals of our service department.

The **Streamline endoscope exchange program** is the perfect example of these commitments.

Streamline exchange program allows you to exchange your defective autoclavable optics from any brands for a newly manufactured SOPRO-COMEG optics.

All Streamline endoscopes are manufactured in our plant in Tuttlingen, Germany, with original parts to fulfill all specifications, standards and regulatory compliance ISO 13485 as the other SOPRO-COMEG optics. All individual parts are carefully checked by our incoming inspection department before assembly to achieve the quality you need.

**48h:** it's the time we need to send you your Streamline endoscope after receipt of your order.

**Whatever is the autoclavable optics you send to us we provide your needs.**

As example, you can send us a broken autoclavable sinuscope from other brand and asking for a SOPRO-COMEG Full HD Streamline 10mm laparoscope.

Nevertheless, the SOPRO-COMEG optics technology permits to proceed, most of the time, to a repair. After expertise of your medical device, our technician will sent you a repair offer according to the repair flat rate. If the device cannot be repair we will send you an offer for a Streamline product or, if the optics is not eligible to this Streamline exchange program, a very attractive pricing for new endoscope.



Cystoscopy



Gynecology



Sinuscopy

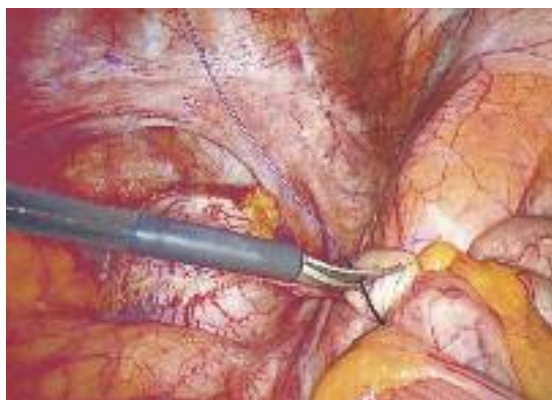

Laparoscopy

## General information

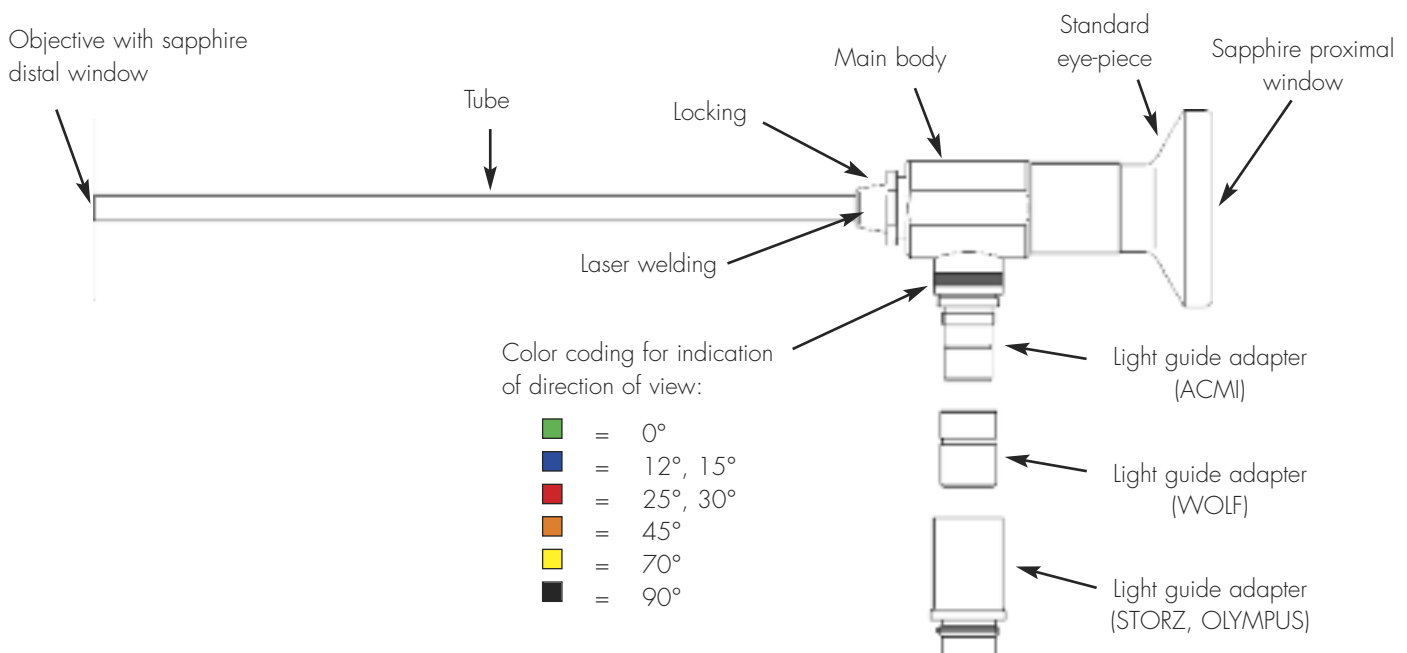

### Direction of view

Direction of view is defined by the angle between the deviation of the middle beam and the axis of the optical system.

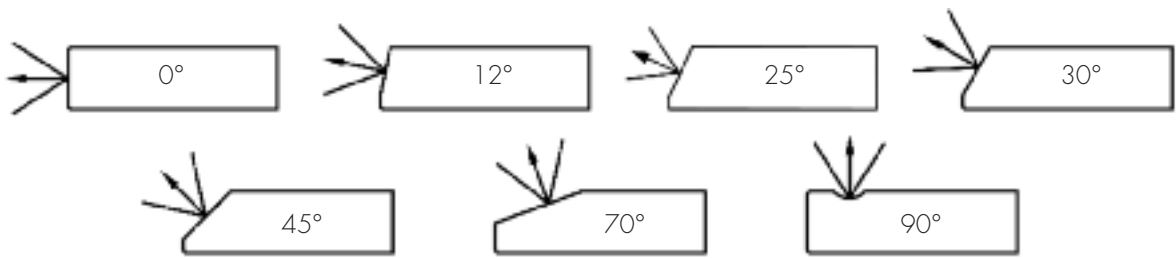

### Field of view

Field of view is defined by the angle between the most left and right peripheral beam of the image. It is important for the distinction of wide-angle and standard-angle telescopes.



### "WIDE ANGLE" (WA)

"Wide angle" telescopes provide a bigger field of view.

Telescopes

Company

Optics

Trocars

Dissecting and grasping forceps

Scissors biopsy forceps

Instruments for coagulation

Divers accessories

Suture and ligature

Sterilization and maintenance

Art.-No.  
**163 202 600**

**Straight forward telescope 0° wide angle** 

Enlarged view  
Ø 2mm  
Length 260mm  
With rod lenses optical system  
Autoclavable  
With fiber optic light transmission incorporated  
Color code: ■

Art.-No.  
**163 202 990**

**Straight forward telescope 0°** 

Ø 2mm  
Length 235mm  
With fiber optical system  
Autoclavable  
With fiber optic light transmission incorporated  
Color code: ■

Art.-No.  
**163 312 990**

**Straight forward telescope 0° wide angle** 

Enlarged view  
Ø 3mm  
Length 301mm  
With rod lenses optical system  
Autoclavable  
With fiber optic light transmission incorporated  
Color code: ■

Art.-No.  
**163 312 992**

**Forward oblique telescope 30° wide angle** 

Enlarged view  
Ø 3mm  
Length 301mm  
With rod lenses optical system  
Autoclavable  
With fiber optic light transmission incorporated  
Color code: ■

Art.-No.  
**162 053 040**

**Straight forward telescope 0°** 

Enlarged view  
Ø 5mm  
Length 306mm  
With rod lenses optical system  
Autoclavable  
With fiber optic light transmission incorporated  
Color code: ■

Art.-No.  
**162 053 042**

**Forward oblique telescope 30°** 

Enlarged view  
Ø 5mm  
Length 306mm  
With rod lenses optical system  
Autoclavable  
With fiber optic light transmission incorporated  
Color code: ■

Art.-No.  
**162 053 043**

**Straight forward telescope 45°** 

Enlarged view  
Ø 5mm  
Length 306mm  
With rod lenses optical system  
Autoclavable  
With fiber optic light transmission incorporated  
Color code: ■



## Telescopes



Art.-No.  
**162 053 150** FULL HD

### Straight forward telescope 0°

Enlarged view   
 Ø 5,5mm  
 Length 316mm  
 With rod lenses optical system  
 Autoclavable  
 With fiber optic light transmission incorporated  
 Color code: ■

Art.-No.  
**162 053 152** FULL HD

### Forward oblique telescope 30°

Enlarged view   
 Ø 5,5mm  
 Length 316mm  
 With rod lenses optical system  
 Autoclavable  
 With fiber optic light transmission incorporated  
 Color code: ■

Art.-No.  
**162 053 153** FULL HD

### Forward oblique telescope 45°

Enlarged view   
 Ø 5,5mm  
 Length 316mm  
 With rod lenses optical system  
 Autoclavable  
 With fiber optic light transmission incorporated  
 Color code: ■



Art.-No.  
**162 054 500** FULL HD

### Straight forward telescope 0°

Enlarged view   
 Ø 5,5mm  
 Length 458mm  
 With rod lenses optical system  
 Autoclavable  
 With fiber optic light transmission incorporated  
 Color code: ■

Art.-No.  
**162 054 502** FULL HD

### Forward oblique telescope 30°

Enlarged view   
 Ø 5,5mm  
 Length 458mm  
 With rod lenses optical system  
 Autoclavable  
 With fiber optic light transmission incorporated  
 Color code: ■

Art.-No.  
**162 054 503** FULL HD

### Forward oblique telescope 45°

Enlarged view   
 Ø 5,5mm  
 Length 458mm  
 With rod lenses optical system  
 Autoclavable  
 With fiber optic light transmission incorporated  
 Color code: ■

Telescopes



Art.-No.

**162 103 250** FULL HD

**FULL HD Straight forward telescope 0°**

Enlarged view  
 Ø 10mm  
 Length 323mm  
 With rod lenses optical system  
 Autoclavable  
 With fiber optic light transmission incorporated  
 Color code: ■



Art.-No.

**162 103 252** FULL HD

**FULL HD Forward oblique telescope 30°**

Enlarged view  
 Ø 10mm  
 Length 325mm  
 With rod lenses optical system  
 Autoclavable  
 With fiber optic light transmission incorporated  
 Color code: ■



Art.-No.

**162 103 253** FULL HD

**FULL HD Forward oblique telescope 45°**

Enlarged view  
 Ø 10mm  
 Length 325mm  
 With rod lenses optical system  
 Autoclavable  
 With fiber optic light transmission incorporated  
 Color code: ■



Art.-No.

**162 104 500**

**Straight forward telescope 0°**

Enlarged view  
 Ø 10mm  
 Length 450mm  
 With rod lenses optical system  
 Autoclavable  
 With fiber optic light transmission incorporated  
 Color code: ■



Art.-No.

**162 104 502**

**Forward oblique telescope 30°**

Enlarged view  
 Ø 10mm  
 Length 450mm  
 With rod lenses optical system  
 Autoclavable  
 With fiber optic light transmission incorporated  
 Color code: ■



Art.-No.

**162 104 503**

**Forward oblique telescope 45°**

Enlarged view  
 Ø 10mm  
 Length 450mm  
 With rod lenses optical system  
 Autoclavable  
 With fiber optic light transmission incorporated  
 Color code: ■



## Telescopes



Art.-No.  
**162 102 730**

**Straight forward telescope 0°** 

with parallel eyepiece,  
Enlarged view  
Ø 10mm  
Length 273mm  
With rod lenses optical system  
Autoclavable  
With fiber optic light transmission incorporated  
With 5mm working channel  
Color code: ■

Art.-No.  
**162 102 740**

**Straight forward telescope 0°** 

with parallel eyepiece,  
Enlarged view  
Ø 10mm  
Length 273mm  
With rod lenses optical system  
Autoclavable  
With fiber optic light transmission incorporated  
With 6mm working channel  
Color code: ■



Art.-No.  
**162 122 771**

**Straight forward telescope 12°** 

with parallel eyepiece,  
Enlarged view  
Ø 12mm  
Length 273mm  
With rod lenses optical system  
Autoclavable  
With fiber optic light transmission incorporated  
With 7,5mm working channel  
Color code: ■

## Telescopes

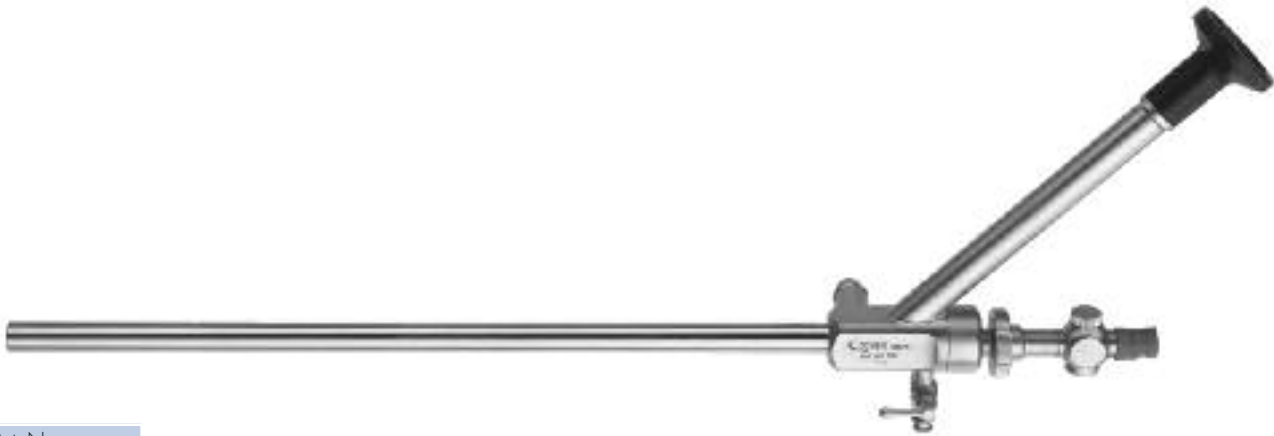

Art.-No.

**162 102 760****Straight forward telescope 0°** 

with lateral eyepiece,  
 Enlarged view  
 Ø 10mm  
 Length 273mm  
 With rod lenses optical system  
 Autoclavable  
 With fiber optic light transmission incorporated  
 With 6mm working channel  
 Color code: ■



Art.-No.

**162 101 702****Thoracoscope Forward oblique telescope 30° wide angle** 

Enlarged view  
 Ø 10mm  
 Length 178 mm  
 With rod lenses optical system  
 Autoclavable  
 With fiber optic light transmission incorporated  
 Color code: ■

## Telescopes



Art.-No.  
**164 044 510**

**Straight forward bronchoscope 0°** 

Ø 4 mm  
Length 492mm  
With rod lenses optical system  
Autoclavable  
With fiber optic light transmission incorporated  
Color code: ■

Art.-No.  
**164 053 630**

**Straight forward bronchoscope 0°** 

Ø 5,5 mm  
Length 363mm  
With rod lenses optical system  
Autoclavable  
With fiber optic light transmission incorporated  
Color code: ■

Art.-No.  
**164 055 000**

**Straight forward bronchoscope 0°** 

Ø 5,5 mm  
Length 489mm  
With rod lenses optical system  
Autoclavable  
With fiber optic light transmission incorporated  
Color code: ■



SOPRO  
COMEG



SOPRO  
COMEG





### **3 • TROCARS**

Trocar sleeves . . . . .	p24
Trocars . . . . .	p29
Veress insufflation needles . . . . .	p33
Reducers . . . . .	p35
Dilatation sets . . . . .	p37

## Trocar sleeves



Art.-No.

**191 031 070****Ø 3.5 mm trocar sleeve with separate opening lever**

Smooth metal tube

One fixed stopcock for insufflation

Working length 70 mm

For Ø 3 mm outer diameter laparoscopes or instruments

Art.-No.

**191 051 070****Ø 5.5 mm trocar sleeve with separate opening lever**

Smooth metal tube

One fixed stopcock for insufflation

Working length 95 mm

For Ø 5 or 5,5 mm outer diameter laparoscopes or instruments

Art.-No.

**191 051 110****Ø 5.5 mm Trocar sleeve with separate opening lever**

Smooth metal tube

One fixed stopcock for insufflation

Working length 150 mm

For Ø 5 or 5,5mm outer diameter laparoscopes and instruments

Art.-No.

**191 071 071****Ø 7 mm Trocar sleeve with separate opening lever**

Smooth metal tube

One fixed stopcock for insufflation

Working length 95 mm

For Ø 6 mm outer diameter laparoscopes and instruments

Art.-No.

**191 101 070****Ø 10 mm trocar sleeve with separate opening lever**

Smooth metal tube

One fixed stopcock for insufflation

Working length 97 mm

For Ø 10 mm outer diameter laparoscopes or instruments

Art.-No.

**191 111 070****Ø 11 mm trocar sleeve with separate opening lever**

Smooth metal tube

One fixed stopcock for insufflation

Working length 101 mm

For Ø 10 mm outer diameter laparoscopes or instruments

Art.-No.

**191 111 110****Ø 11 mm Trocar sleeve with separate opening lever**

Smooth metal tube

One fixed stopcock for insufflation

Working length 150 mm

For Ø 10 mm outer diameter laparoscopes and instruments

Art.-No.

**191 120 070****Ø 12.5 mm trocar sleeve with separate opening lever**

Smooth metal tube

One fixed stopcock for insufflation

Working length 98 mm

For Ø 12 mm outer diameter laparoscopes or instruments

Art.-No.

**191 120 110****Ø 12.5 mm Trocar sleeve with separate opening lever**

Smooth metal tube

One fixed stopcock for insufflation

Working length 150 mm

For Ø 12 mm outer diameter laparoscopes and instruments

Art.-No.

**191 150 070****Ø 15 mm Trocar sleeve with separate opening lever**

Smooth metal tube

One fixed stopcock for insufflation

Working length 110 mm

For Ø 15 mm outer diameter laparoscopes and instruments

Art.-No.

**191 201 070****Ø 20 mm Trocar sleeve with separate opening lever**

Smooth metal tube

One fixed stopcock for insufflation

Working length 119 mm

For Ø 20 mm outer diameter laparoscopes and instruments

## Trocar sleeves



Art.-No.

**191 051 090****Ø 5.5 mm Trocar sleeve with separate opening lever**

Metal tube with thread

One fixed stopcock for insufflation

Working length 95 mm

For Ø 5 or 5,5 mm outer diameter laparoscopes and instruments

Art.-No.

**191 111 090****Ø 11 mm Trocar sleeve with separate opening lever**

Metal tube with thread

One fixed stopcock for insufflation

Working length 101 mm

For Ø 10 mm outer diameter laparoscopes and instruments

Art.-No.

**191 120 090****Ø 12.5 mm Trocar sleeve with separate opening lever**

Metal tube with thread

One fixed stopcock for insufflation

Working length 98 mm

For Ø 12 mm outer diameter laparoscopes and instruments

Trocar sleeves



Art.-No.  
**191 031 080**

**Ø 3.5 mm Trocar sleeve with silicone valve**  
Smooth metal tube  
One fixed stopcock for insufflation  
Working length 70 mm  
For Ø 3 mm outer diameter laparoscopes and instruments

Art.-No.  
**191 051 080**

**Ø 5.5 mm Trocar sleeve with silicone valve**  
Smooth metal tube  
One fixed stopcock for insufflation  
Working length 95 mm  
For Ø 5 mm or 5,5 outer diameter laparoscopes and instruments

Art.-No.  
**191 051 120**

**Ø 5.5 mm Trocar sleeve with silicone valve**  
Smooth metal tube  
One fixed stopcock for insufflation  
Working length 150 mm  
For Ø 5 or 5,5 mm outer diameter laparoscopes and instruments

Art.-No.  
**191 070 080**

**Ø 7 mm Trocar sleeve with silicone valve**  
Smooth metal tube  
One fixed stopcock for insufflation  
Working length 105 mm  
For Ø 6 mm outer diameter laparoscopes and instruments

Art.-No.  
**191 101 080**

**Ø 10 mm Trocar sleeve with silicone valve**  
Smooth metal tube  
One fixed stopcock for insufflation  
Working length 97 mm  
For Ø 10 mm outer diameter laparoscopes and instruments

Art.-No.  
**191 111 080**

**Ø 11 mm Trocar sleeve with silicone valve**  
Smooth metal tube  
One fixed stopcock for insufflation  
Working length 101 mm  
For Ø 10 mm outer diameter laparoscopes and instruments

Art.-No.  
**191 111 120**

**Ø 11 mm Trocar sleeve with silicone valve**  
Smooth metal tube  
One fixed stopcock for insufflation  
Working length 150 mm  
For Ø 10 mm outer diameter laparoscopes and instruments

Art.-No.  
**191 120 080**

**Ø 12.5 mm Trocar sleeve with silicone valve**  
Smooth metal tube  
One fixed stopcock for insufflation  
Working length 98 mm  
For Ø 12 mm outer diameter laparoscopes and instruments

Art.-No.  
**191 120 120**

**Ø 12.5 mm Trocar sleeve with silicone valve**  
Smooth metal tube  
One fixed stopcock for insufflation  
Working length 150 mm  
For Ø 12 mm outer diameter laparoscopes and instruments

All these references are distributed only outside Germany

## Trocar sleeves



Art.-No.

**191 051 100****Ø 5.5 mm Trocar sleeve with silicone valve**

Metal tube with thread

One fixed stopcock for insufflation

Working length 95 mm

For Ø 5 or 5,5 mm outer diameter laparoscopes and instruments

Art.-No.

**191 120 100****Ø 12.5 mm Trocar sleeve with silicone valve**

Metal tube with thread

One fixed stopcock for insufflation

Working length 98 mm

For Ø 12 mm outer diameter laparoscopes and instruments

Art.-No.

**191 111 100****Ø 11 mm Trocar sleeve with silicone valve**

Metal tube with thread

One fixed stopcock for insufflation

Working length 101 mm

For Ø 10 mm outer diameter laparoscopes and instruments

*All these references are distributed only outside Germany*

## Trocars sleeves

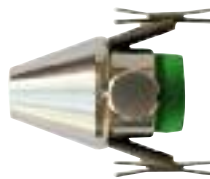

Art.-No.  
**191 031 940**

**Hasson cone for Ø 3.5 mm trocar sleeves**  
Suture holder

Art.-No.  
**191 051 940**

**Hasson cone for Ø 5.5 mm trocar sleeves**  
Suture holder

Art.-No.  
**191 111 940**

**Hasson cone for Ø 11 mm trocar sleeves**  
Suture holder

Art.-No.  
**191 120 940**

**Hasson cone for Ø 12.5 mm trocar sleeves**  
Suture holder

## Trocar



Art.-No.

**191 031 900****Ø 3.5 mm Trocar**

Conical tip

To use with Ø 3.5 mm trocar sleeve

Art.-No.

**191 051 900****Ø 5.5 mm Trocar**

Conical tip

To use with Ø 5.5 mm trocar sleeve

Art.-No.

**191 051 980****Ø 5.5 mm Trocar**

Conical tip

To use with Ø 5,5 mm trocar sleeve with 150 mm working length

Art.-No.

**191 070 900****Ø 7 mm Trocar**

Conical tip

To use with Ø 7 mm trocar sleeve

Art.-No.

**191 101 900****Ø 10 mm Trocar**

Conical tip

To use with Ø 10 mm trocar sleeve

Art.-No.

**191 101 980****Ø 10 mm Trocar**

Conical tip

To use with Ø 10 mm trocar sleeve with 150mm working length

Art.-No.

**191 111 900****Ø 11 mm Trocar**

Conical tip

To use with Ø 11 mm trocar sleeve

Art.-No.

**191 111 980****Ø 11 mm Trocar**

Conical tip

To use with Ø 11 mm trocar sleeve with 150mm working length

Art.-No.

**191 120 900****Ø 12.5 mm Trocar**

Conical tip

To use with Ø 12.5 mm trocar sleeve

Art.-No.

**191 120 980****Ø 12.5 mm Trocar**

Conical tip

length 150 mm

To use with Ø 12.5 mm trocar sleeve with 150mm working length

Art.-No.

**191 150 900****Ø 15 mm Trocar**

Conical tip

To use with Ø 15 mm trocar sleeve

Art.-No.

**191 201 911****Ø 20 mm Trocar**

Conical tip

To use with Ø 20 mm trocar sleeve



## Trocars



Art.-No.

**191 031 910****Ø 3.5 mm Trocar**

Pyramidal tip

To use with Ø 3.5 mm trocar sleeve

Art.-No.

**191 051 910****Ø 5.5 mm Trocar**

Pyramidal tip

To use with Ø 5.5 mm trocar sleeve

Art.-No.

**191 051 960****Ø 5.5 mm Trocar**

Pyramidal tip

To use with Ø 5.5 mm trocar sleeve with 150mm working length

Art.-No.

**191 070 910****Ø 7 mm Trocar**

Pyramidal tip

To use with Ø 7 mm trocar sleeve

Art.-No.

**191 101 910****Ø 10 mm Trocar**

Pyramidal tip

To use with Ø 10 mm trocar sleeve

Art.-No.

**191 111 910****Ø 11 mm Trocar**

Pyramidal tip

To use with Ø 11 mm trocar sleeve

Art.-No.

**191 111 960****Ø 11 mm Trocar**

Pyramidal tip

To use with Ø 11 mm trocar sleeve with 150mm working length

Art.-No.

**191 120 910****Ø 12.5 mm Trocar**

Pyramidal tip

To use with Ø 12.5 mm trocar sleeve

Art.-No.

**191 120 960****Ø 12.5 mm Trocar**

Pyramidal tip

To use with Ø 12.5 mm trocar sleeve with 150mm working length

Art.-No.

**191 150 910****Ø 15 mm Trocar**

Pyramidal tip

To use with Ø 15 mm trocar sleeve

Art.-No.

**191 201 910****Ø 20 mm Trocar**

Pyramidal tip

To use with Ø 20 mm trocar sleeve

## Trocars



Art.-No.

**191 031 930****Ø 3.5 mm Trocar**

Conical blunt

To use with Ø 3.5 mm trocar sleeve

Art.-No.

**191 051 930****Ø 5.5 mm Trocar**

Conical blunt

To use with Ø 5.5 mm trocar sleeve

Art.-No.

**191 101 930****Ø 10 mm Trocar**

Conical blunt

To use with Ø 10 mm trocar sleeve

Art.-No.

**191 111 930****Ø 11 mm Trocar**

Conical blunt

To use with Ø 11 mm trocar sleeve

Art.-No.

**191 120 930****Ø 12.5 mm Trocar**

Conical blunt

To use with Ø 12.5 mm trocar sleeve



Art.-No.

**191 051 950****Ø 5.5 mm Safety trocar with automatic locking**

Pyramidal grinding and rounded tip

Length 160 mm

To use with Ø 5.5 mm trocar sleeve

Art.-No.

**191 051 970****Ø 5.5 mm Safety trocar with automatic locking**

Pyramidal grinding and rounded tip

Length 215 mm

To use with Ø 5.5 mm trocar sleeve with 150mm working length

Art.-No.

**191 101 950****Ø 10 mm Safety trocar with automatic locking**

Pyramidal grinding and rounded tip

Length 167 mm

To use with Ø 10 mm trocar sleeve

Art.-No.

**191 111 950****Ø 11 mm Safety trocar with automatic locking**

Pyramidal grinding and rounded tip

Length 171 mm

To use with Ø 11 mm trocar sleeve

Art.-No.

**191 111 970****Ø 11 mm Safety trocar with automatic locking**

Pyramidal grinding and rounded tip

Length 220 mm

To use with Ø 11 mm trocar sleeve with 150mm working length

Art.-No.

**191 120 950****Ø 12.5 mm Safety trocar with automatic locking**

Pyramidal grinding and rounded tip

Length 171 mm

To use with Ø 12.5 mm trocar sleeve

Art.-No.

**191 120 970****Ø 12.5 mm Safety trocar with automatic locking**

Pyramidal grinding and rounded tip

Length 223 mm

To use with Ø 12.5 mm trocar sleeve with 150mm working length

Trocars



Art.-No.  
**191 051 990**

**Ø 5.5 mm Protection trocar**  
Halfmoon grinding and oblique tip  
Length 160 mm  
To use with Ø 5.5 mm trocar sleeve

Art.-No.  
**191 111 990**

**Ø 11 mm Protection trocar**  
Halfmoon grinding and oblique tip  
Length 171 mm  
To use with Ø 11 mm trocar sleeve

Art.-No.  
**191 101 990**

**Ø 10 mm Protection trocar**  
Halfmoon grinding and oblique tip  
Length 167 mm  
To use with Ø 10 mm trocar sleeve

Art.-No.  
**191 120 990**

**Ø 12.5 mm Protection trocar**  
Halfmoon grinding and oblique tip  
Length 171 mm  
To use with Ø 12.5 mm trocar sleeve

## Veress insufflation needles



Art.-No.

**391 020 070****Ø 2 mm Veress insufflation needle**

Chrome plated  
Stopcock and Luer-Lock connection  
Length 70 mm

Art.-No.

**391 020 100****Ø 2 mm Veress insufflation needle**

Chrome plated  
Stopcock and Luer-Lock connection  
Length 100 mm

Art.-No.

**391 020 120****Ø 2 mm Veress insufflation needle**

Chrome plated  
Stopcock and Luer-Lock connection  
Length 120 mm

Art.-No.

**391 020 140****Ø 2 mm Veress insufflation needle**

Chrome plated  
Stopcock and Luer-Lock connection  
Length 140 mm

Art.-No.

**391 020 060****Ø 2 mm Veress insufflation needle**

Chrome plated  
Stopcock and Luer-Lock connection  
Length 150 mm

Art.-No.

**391 027 100****Ø 2.7 mm Veress insufflation needle**

Chrome plated  
Stopcock and Luer-Lock connection  
Length 100 mm

Art.-No.

**391 027 120****Ø 2.7 mm Veress insufflation needle**

Chrome plated  
Stopcock and Luer-Lock connection  
Length 120 mm

Art.-No.

**391 027 150****Ø 2.7 mm Veress insufflation needle**

Chrome plated  
Stopcock and Luer-Lock connection  
Length 150 mm

Art.-No.

**391 027 170****Ø 2.7 mm Veress insufflation needle**

Chrome plated  
Stopcock and Luer-Lock connection  
Length 170 mm

Veress insufflation needles



Art.-No.  
**391 120 100**

**Ø 2 mm Veress insufflation needle**  
Stainless steel  
Stopcock and Luer-Lock connection  
Length 100 mm

Art.-No.  
**391 127 100**

**Ø 2.7 mm Veress insufflation needle**  
Stainless steel  
Stopcock and Luer-Lock connection  
Length 100 mm

Art.-No.  
**391 120 120**

**Ø 2 mm Veress insufflation needle**  
Stainless steel  
Stopcock and Luer-Lock connection  
Length 120 mm

Art.-No.  
**391 127 120**

**Ø 2.7 mm Veress insufflation needle**  
Stainless steel  
Stopcock and Luer-Lock connection  
Length 120 mm

Art.-No.  
**391 120 150**

**Ø 2 mm Veress insufflation needle**  
Stainless steel  
Stopcock and Luer-Lock connection  
Length 150 mm

Art.-No.  
**391 127 150**

**Ø 2.7 mm Veress insufflation needle**  
Stainless steel  
Stopcock and Luer-Lock connection  
Length 150 mm

## Reducers

Art.-No.  
**392 998 001**

**Plastic reducer adaptors**  
Ø 10 mm → Ø 5.5 mm  
Silicone trap

Art.-No.  
**392 998 004**

**Plastic reducer adaptors**  
Ø 12.5 mm → Ø 10 mm  
Silicone trap

Art.-No.  
**392 998 002**

**Plastic reducer adaptors**  
Ø 11 mm → Ø 5.5 mm  
Silicone trap

Art.-No.  
**392 998 003**

**Plastic reducer adaptors**  
Ø 12.5 mm → Ø 5.5 mm  
Silicone trap



Art.-No.  
**392 998 005**

**Plastic sliding reducer adaptors**  
Ø 10 mm → Ø 5.5 mm

Art.-No.  
**392 998 007**

**Plastic sliding reducer adaptors**  
Ø 12.5 mm → Ø 5.5 mm

Art.-No.  
**392 998 006**

**Plastic sliding reducer adaptors**  
Ø 11 mm → Ø 5.5 mm

Art.-No.  
**392 998 008**

**Plastic sliding reducer adaptors**  
Ø 12.5 mm → Ø 10 mm



Reducers



Art.-No.  
**392 999 000**

**Reducer sleeves**  
Ø10 mm → Ø 5.5 mm  
Length 190 mm

Art.-No.  
**392 999 003**

**Reducer sleeves**  
Ø12.5 mm → Ø 10 mm  
Length 190 mm

Art.-No.  
**392 999 006**

**Reducer sleeves**  
Ø20 mm → Ø 15 mm  
Length 190 mm

Art.-No.  
**392 999 001**

**Reducer sleeves**  
Ø11 mm → Ø 5.5 mm  
Length 190 mm

Art.-No.  
**392 999 004**

**Reducer sleeves**  
Ø15 mm → Ø 10 mm  
Length 190 mm

Art.-No.  
**392 999 007**

**Reducer sleeves**  
Ø20 mm → Ø 10 mm  
Length 190 mm

Art.-No.  
**392 999 002**

**Reducer sleeves**  
Ø12.5 mm → Ø 5.5 mm  
Length 190 mm

Art.-No.  
**392 999 005**

**Reducer sleeves**  
Ø15 mm → Ø 5.5 mm  
Length 190 mm

Art.-No.  
**392 999 008**

**Reducer sleeves**  
Ø20 mm → Ø 5.5 mm  
Length 190 mm



## Dilatation sets



Art.-No.

**392 999 100****Ø 5 mm → 10 mm Dilatation set**

Consisting of dilator sleeve dilator  
Length 6 mm

Art.-No.

**392 999 111****Ø 5 mm → 11 mm Dilatation set**

Consisting of dilator sleeve dilator  
Length 6 mm

Art.-No.

**392 999 101****Ø 5 mm → 15 mm Dilatation set**

Consisting of dilator sleeve dilator  
Length 6 mm

Art.-No.

**392 999 103****Ø 5 mm → 20 mm Dilatation set**

Consisting of dilator sleeve dilator  
Length 6 mm

Art.-No.

**392 999 102****Ø 10 mm → 15 mm Dilatation set**

Consisting of dilator sleeve dilator  
Length 95 mm

Art.-No.

**392 999 104****Ø 10mm → 20 mm Dilatation set**

Consisting of dilator sleeve dilator  
Length 95 mm

The logo features two curved, swoosh-like shapes. The top swoosh is light green and curves from the right side towards the center. The bottom swoosh is light blue and curves from the left side towards the center. The text 'SOPRO' and 'COMEG' is centered between these two swooshes.

**SOPRO**  
**COMEG**



## **4 • DISSECTING AND GRASPING FORCEPS**

Instrumentation . . . . .	p40
Plastic handles . . . . .	p41
Metal handles . . . . .	p42
Tube shafts . . . . .	p43
Instrumentation Ø 3 mm . . . . .	p44
Instrumentation Ø 5 mm . . . . .	p47
Instrumentation Ø 10 mm . . . . .	p61
Monopolar cables . . . . .	p66

## Instrumentation

### Mechanical snap-action coupling

The modular laparoscopic instruments with  $\varnothing$  5 mm and  $\varnothing$  10 mm have a unique snap-action coupling which offers the combined advantage of the speediest possible assembly and a long service life.

The union of the working insert and sleeve shaft is achieved by simply inserting the components axially into each other: A simple click and you are ready!

The groove-and-tongue principle practically rules out the possibility of the locking mechanism coming undone, as it is the case with conventional screw or bayonet connections.

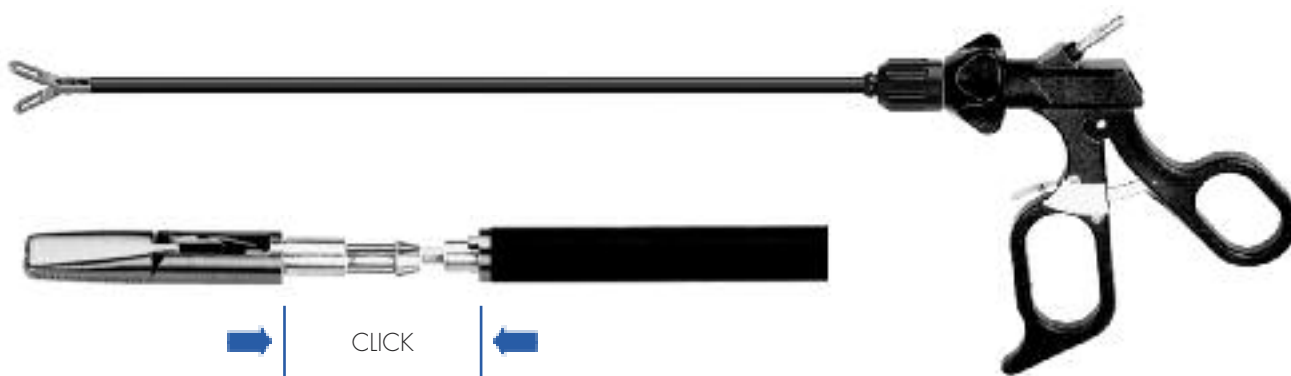

### Nut stopper

A nut on the sleeve shaft of our modular instruments prevents bothersome slipping or even the loss of the union nut.



## Plastic handles

Art.-No.  
393 011 100

**Ergonomic highly rigid plastic ring handle with rotation module and HF connection**



Art.-No.  
393 021 100

**Ergonomic highly rigid plastic ring handle with ratchet, rotation module and HF connection**



Art.-No.  
393 031 100

**Ergonomic highly rigid plastic ring handle with stepless ratchet, ratchet releasing key, rotation module and HF connection**



# 4 Dissecting and grasping forceps

Company

Optics

Trocars

Dissecting and grasping forceps

Scissors biopsy forceps

Instruments for coagulation

Divers accessories

Suture and ligature

Sterilization and maintenance

## Metal handles

Art.-No.

**393 041 100**

**Axial ring handle, with ratchet**

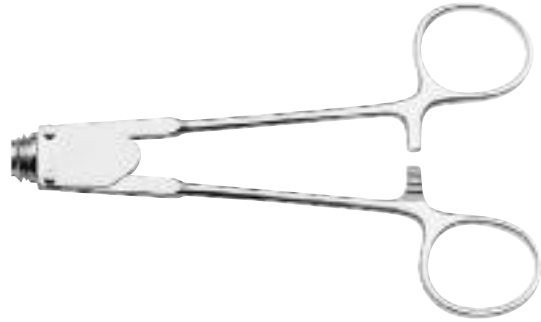

Art.-No.

**393 051 100**

**Axial handle, with spreading spring and ratchet**

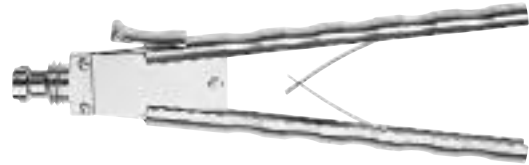

Art.-No.

**393 061 100**

**Axial handle, with spreading spring**

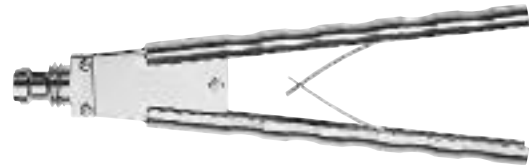

## Tube shafts



Art.-No.  
**393 501 100**

**Ø 5 mm Tube shaft insulated**  
With Luer-Lock  
Length 330 mm

Art.-No.  
**394 501 200**

**Ø 5 mm Tube shaft insulated**  
With Luer-Lock  
Length 450 mm

Art.-No.  
**393 501 300**

**Ø 5 mm Tube shaft insulated**  
With Luer-Lock  
Length 360 mm



Art.-No.  
**393 901 100**

**Ø 10 mm Tube shaft insulated**  
With Luer-Lock  
Length 330 mm

Art.-No.  
**394 901 200**

**Ø 10 mm Tube shaft insulated**  
With Luer-Lock  
Length 450 mm

Art.-No.  
**393 901 200**

**Ø 10 mm Tube shaft insulated**  
With Luer-Lock  
Length 360 mm

## Instrumentation Ø 3 mm

### Ø 3 mm Universal grasping forceps

Double action jaws

Complete instrument	Insert	Handle	Length
393 310 018	393 300 018	393 011 100	210 mm
393 320 018	393 300 018	393 021 100	210 mm
393 330 018	393 300 018	393 031 100	210 mm
393 310 118	393 300 118	393 011 100	180 mm
393 320 118	393 300 118	393 021 100	180 mm
393 330 118	393 300 118	393 031 100	180 mm
393 310 218	393 300 218	393 011 100	330 mm
393 320 218	393 300 218	393 021 100	330 mm
393 330 218	393 300 218	393 031 100	330 mm



### Ø 3 mm Maryland grasping forceps

Double action jaws

Complete instrument	Insert	Handle	Length
393 310 043	393 300 043	393 011 100	210 mm
393 320 043	393 300 043	393 021 100	210 mm
393 330 043	393 300 043	393 031 100	210 mm
393 310 143	393 300 143	393 011 100	180 mm
393 320 143	393 300 143	393 021 100	180 mm
393 330 143	393 300 143	393 031 100	180 mm
393 310 243	393 300 243	393 011 100	330 mm
393 320 243	393 300 243	393 021 100	330 mm
393 330 243	393 300 243	393 031 100	330 mm



### Ø 3 mm Dissecting forceps, fenestrated

Double action jaws

Complete instrument	Insert	Handle	Length
393 310 034	393 300 034	393 011 100	210 mm
393 320 034	393 300 034	393 021 100	210 mm
393 330 034	393 300 034	393 031 100	210 mm
393 310 134	393 300 134	393 011 100	180 mm
393 320 134	393 300 134	393 021 100	180 mm
393 330 134	393 300 134	393 031 100	180 mm
393 310 234	393 300 234	393 011 100	330 mm
393 320 234	393 300 234	393 021 100	330 mm
393 330 234	393 300 234	393 031 100	330 mm





## Instrumentation Ø 3 mm

### Ø 3 mm Grasping forceps with reservoir, blunt

Double action jaws



Complete instrument	Insert	Handle	Length
393 310 010	393 300 010	393 011 100	210 mm
393 320 010	393 300 010	393 021 100	210 mm
393 330 010	393 300 010	393 031 100	210 mm
393 310 110	393 300 110	393 011 100	180 mm
393 320 110	393 300 110	393 021 100	180 mm
393 330 110	393 300 110	393 031 100	180 mm
393 310 210	393 300 210	393 011 100	330 mm
393 320 210	393 300 210	393 021 100	330 mm
393 330 210	393 300 210	393 031 100	330 mm

### Ø 3 mm Grasping forceps with reservoir, sharp

Double action jaws



Complete instrument	Insert	Handle	Length
393 310 011	393 300 011	393 011 100	210 mm
393 320 011	393 300 011	393 021 100	210 mm
393 330 011	393 300 011	393 031 100	210 mm
393 310 111	393 300 111	393 011 100	180 mm
393 320 111	393 300 111	393 021 100	180 mm
393 330 111	393 300 111	393 031 100	180 mm
393 310 211	393 300 211	393 011 100	330 mm
393 320 211	393 300 211	393 021 100	330 mm
393 330 211	393 300 211	393 031 100	330 mm

### Ø 3 mm Dolphin grasping forceps

Double action jaws



Complete instrument	Insert	Handle	Length
393 310 024	393 300 024	393 011 100	210 mm
393 320 024	393 300 024	393 021 100	210 mm
393 330 024	393 300 024	393 031 100	210 mm
393 310 124	393 300 124	393 011 100	180 mm
393 320 124	393 300 124	393 021 100	180 mm
393 330 124	393 300 124	393 031 100	180 mm
393 310 224	393 300 224	393 011 100	330 mm
393 320 224	393 300 224	393 021 100	330 mm
393 330 224	393 300 224	393 031 100	330 mm

# 4 Dissecting and grasping forceps

Company

Optics

Trocars

Dissecting and grasping forceps

Scissors biopsy forceps

Instruments for coagulation

Divers accessories

Suture and ligature

Sterilization and maintenance

## Instrumentation Ø 3 mm

### Ø 3 mm Grasping forceps, sharp, crosswise teeth

Jaw length 12 mm  
Double action jaws



Complete instrument	Insert	Handle	Length
393 310 019	393 300 019	393 011 100	210 mm
393 320 019	393 300 019	393 021 100	210 mm
393 330 019	393 300 019	393 031 100	210 mm
393 310 119	393 300 119	393 011 100	180 mm
393 320 119	393 300 119	393 021 100	180 mm
393 330 119	393 300 119	393 031 100	180 mm
393 310 219	393 300 219	393 011 100	330 mm
393 320 219	393 300 219	393 021 100	330 mm
393 330 219	393 300 219	393 031 100	330 mm

### Ø 3 mm Claw grasping and extracting forceps

2 + 3 teeth  
Single action jaws



Complete instrument	Insert	Handle	Length
393 310 001	393 300 001	393 011 100	210 mm
393 320 001	393 300 001	393 021 100	210 mm
393 330 001	393 300 001	393 031 100	210 mm
393 310 101	393 300 101	393 011 100	180 mm
393 320 101	393 300 101	393 021 100	180 mm
393 330 101	393 300 101	393 031 100	180 mm
393 310 201	393 300 201	393 011 100	330 mm
393 320 201	393 300 201	393 021 100	330 mm
393 330 201	393 300 201	393 031 100	330 mm

## Instrumentation Ø 5 mm

### Ø 5 mm Claw grasping and extracting forceps

2 + 3 teeth  
Single action jaws



Complete instrument	Insert	Tube	Handle	Length
393 510 001	393 500 001	393 501 100	393 011 100	330 mm
393 520 001	393 500 001	393 501 100	393 021 100	330 mm
393 530 001	393 500 001	393 501 100	393 031 100	330 mm
393 510 101	393 500 101	393 501 300	393 011 100	360 mm
393 520 101	393 500 101	393 501 300	393 021 100	360 mm
393 530 101	393 500 101	393 501 300	393 031 100	360 mm
394 510 001	394 500 001	394 501 200	393 011 100	450 mm
394 520 001	394 500 001	394 501 200	393 021 100	450 mm
394 530 001	394 500 001	394 501 200	393 031 100	450 mm

### Ø 5 mm Grasping forceps

2 + 4 teeth  
Double action jaws



Complete instrument	Insert	Tube	Handle	Length
393 510 005	393 500 005	393 501 100	393 011 100	330 mm
393 520 005	393 500 005	393 501 100	393 021 100	330 mm
393 530 005	393 500 005	393 501 100	393 031 100	330 mm
393 510 105	393 500 105	393 501 300	393 011 100	360 mm
393 520 105	393 500 105	393 501 300	393 021 100	360 mm
393 530 105	393 500 105	393 501 300	393 031 100	360 mm
394 510 005	394 500 005	394 501 200	393 011 100	450 mm
394 520 005	394 500 005	394 501 200	393 021 100	450 mm
394 530 005	394 500 005	394 501 200	393 031 100	450 mm

### Ø 5 mm Grasping forceps

Double action jaws



Complete instrument	Insert	Tube	Handle	Length
393 510 012	393 500 012	393 501 100	393 011 100	330 mm
393 520 012	393 500 012	393 501 100	393 021 100	330 mm
393 530 012	393 500 012	393 501 100	393 031 100	330 mm
393 510 112	393 500 112	393 501 300	393 011 100	360 mm
393 520 112	393 500 112	393 501 300	393 021 100	360 mm
393 530 112	393 500 112	393 501 300	393 031 100	360 mm
394 510 012	394 500 012	394 501 200	393 011 100	450 mm
394 520 012	394 500 012	394 501 200	393 021 100	450 mm
394 530 012	394 500 012	394 501 200	393 031 100	450 mm

# 4 Dissecting and grasping forceps

Company

Optics

Trocars

Dissecting and grasping forceps

Scissors biopsy forceps

Instruments for coagulation

Divers accessories

Suture and ligature

Sterilization and maintenance

## Instrumentation Ø 5 mm

### Ø 5 mm Extracting forceps with a row of retrograde teeth

Double action jaws

Complete instrument	Insert	Tube	Handle	Length
393 510 014	393 500 014	393 501 100	393 011 100	330 mm
393 520 014	393 500 014	393 501 100	393 021 100	330 mm
393 530 014	393 500 014	393 501 100	393 031 100	330 mm
393 510 114	393 500 114	393 501 300	393 011 100	360 mm
393 520 114	393 500 114	393 501 300	393 021 100	360 mm
393 530 114	393 500 114	393 501 300	393 031 100	360 mm
394 510 014	394 500 014	394 501 200	393 011 100	450 mm
394 520 014	394 500 014	394 501 200	393 021 100	450 mm
394 530 014	394 500 014	394 501 200	393 031 100	450 mm



### Ø 5 mm Universal grasping forceps

Double action jaws

Complete instrument	Insert	Tube	Handle	Length
393 510 018	393 500 018	393 501 100	393 011 100	330 mm
393 520 018	393 500 018	393 501 100	393 021 100	330 mm
393 530 018	393 500 018	393 501 100	393 031 100	330 mm
393 510 118	393 500 118	393 501 300	393 011 100	360 mm
393 520 118	393 500 118	393 501 300	393 021 100	360 mm
393 530 118	393 500 118	393 501 300	393 031 100	360 mm
394 510 018	394 500 018	394 501 200	393 011 100	450 mm
394 520 018	394 500 018	394 501 200	393 021 100	450 mm
394 530 018	394 500 018	394 501 200	393 031 100	450 mm



### Ø 5 mm Grasping Forceps distal with a row teeth

Single action jaws

Complete instrument	Insert	Tube	Handle	Length
393 510 030	393 500 030	393 501 100	393 011 100	330 mm
393 520 030	393 500 030	393 501 100	393 021 100	330 mm
393 530 030	393 500 030	393 501 100	393 031 100	330 mm
393 510 130	393 500 130	393 501 300	393 011 100	360 mm
393 520 130	393 500 130	393 501 300	393 021 100	360 mm
393 530 130	393 500 130	393 501 300	393 031 100	360 mm
394 510 030	394 500 030	394 501 200	393 011 100	450 mm
394 520 030	394 500 030	394 501 200	393 021 100	450 mm
394 530 030	394 500 030	394 501 200	393 031 100	450 mm



## Instrumentation Ø 5 mm

### Ø 5 mm Grasping forceps smooth

Double action jaws



Complete instrument	Insert	Tube	Handle	Length
393 510 009	393 500 009	393 501 100	393 011 100	330 mm
393 520 009	393 500 009	393 501 100	393 021 100	330 mm
393 530 009	393 500 009	393 501 100	393 031 100	330 mm
393 510 109	393 500 109	393 501 300	393 011 100	360 mm
393 520 109	393 500 109	393 501 300	393 021 100	360 mm
393 530 109	393 500 109	393 501 300	393 031 100	360 mm
394 510 009	394 500 009	394 501 200	393 011 100	450 mm
394 520 009	394 500 009	394 501 200	393 021 100	450 mm
394 530 009	394 500 009	394 501 200	393 031 100	450 mm

### Ø 5 mm Grasping forceps, sharp, crosswise teeth

Jaw length 18 mm

Double action jaws



Complete instrument	Insert	Tube	Handle	Length
393 510 020	393 500 020	393 501 100	393 011 100	330 mm
393 520 020	393 500 020	393 501 100	393 021 100	330 mm
393 530 020	393 500 020	393 501 100	393 031 100	330 mm
393 510 120	393 500 120	393 501 300	393 011 100	360 mm
393 520 120	393 500 120	393 501 300	393 021 100	360 mm
393 530 120	393 500 120	393 501 300	393 031 100	360 mm
394 510 020	394 500 020	394 501 200	393 011 100	450 mm
394 520 020	394 500 020	394 501 200	393 021 100	450 mm
394 530 020	394 500 020	394 501 200	393 031 100	450 mm

### Ø 5 mm Grasping forceps, sharp, crosswise teeth

Jaw length 14 mm

Double action jaws



Complete instrument	Insert	Tube	Handle	Length
393 510 019	393 500 019	393 501 100	393 011 100	330 mm
393 520 019	393 500 019	393 501 100	393 021 100	330 mm
393 530 019	393 500 019	393 501 100	393 031 100	330 mm
393 510 119	393 500 119	393 501 300	393 011 100	360 mm
393 520 119	393 500 119	393 501 300	393 021 100	360 mm
393 530 119	393 500 119	393 501 300	393 031 100	360 mm
394 510 019	394 500 019	394 501 200	393 011 100	450 mm
394 520 019	394 500 019	394 501 200	393 021 100	450 mm
394 530 019	394 500 019	394 501 200	393 031 100	450 mm

# 4 Dissecting and grasping forceps

Company

Optics

Trocars

Dissecting and grasping forceps

Scissors biopsy forceps

Instruments for coagulation

Divers accessories

Suture and ligature

Sterilization and maintenance

## Instrumentation Ø 5mm

### Ø 5 mm Maryland Grasping forceps

Double action jaws

Complete instrument	Insert	Tube	Handle	Length
393 510 042	393 500 042	393 501 100	393 011 100	330 mm
393 520 042	393 500 042	393 501 100	393 021 100	330 mm
393 530 042	393 500 042	393 501 100	393 031 100	330 mm
393 510 142	393 500 142	393 501 300	393 011 100	360 mm
393 520 142	393 500 142	393 501 300	393 021 100	360 mm
393 530 142	393 500 142	393 501 300	393 031 100	360 mm
394 510 042	394 500 042	394 501 200	393 011 100	450 mm
394 520 042	394 500 042	394 501 200	393 021 100	450 mm
394 530 042	394 500 042	394 501 200	393 031 100	450 mm



### Ø 5 mm Kelly Grasping forceps

Double action jaws

Complete instrument	Insert	Tube	Handle	Length
393 510 043	393 500 043	393 501 100	393 011 100	330 mm
393 520 043	393 500 043	393 501 100	393 021 100	330 mm
393 530 043	393 500 043	393 501 100	393 031 100	330 mm
393 510 143	393 500 143	393 501 300	393 011 100	360 mm
393 520 143	393 500 143	393 501 300	393 021 100	360 mm
393 530 143	393 500 143	393 501 300	393 031 100	360 mm
394 510 043	394 500 043	394 501 200	393 011 100	450 mm
394 520 043	394 500 043	394 501 200	393 021 100	450 mm
394 530 043	394 500 043	394 501 200	393 031 100	450 mm



### Ø 5 mm Dolphin grasping forceps

Double action jaws

Complete instrument	Insert	Tube	Handle	Length
393 510 024	393 500 024	393 501 100	393 011 100	330 mm
393 520 024	393 500 024	393 501 100	393 021 100	330 mm
393 530 024	393 500 024	393 501 100	393 031 100	330 mm
393 510 124	393 500 124	393 501 300	393 011 100	360 mm
393 520 124	393 500 124	393 501 300	393 021 100	360 mm
393 530 124	393 500 124	393 501 300	393 031 100	360 mm
394 510 024	394 500 024	394 501 200	393 011 100	450 mm
394 520 024	394 500 024	394 501 200	393 021 100	450 mm
394 530 024	394 500 024	394 501 200	393 031 100	450 mm



## Instrumentation Ø 5 mm

### Ø 5 mm Dolphin grasping forceps long, with reservoir

Double action jaws

Complete instrument	Insert	Tube	Handle	Length
393 510 069	393 500 069	393 501 100	393 011 100	330 mm
393 520 069	393 500 069	393 501 100	393 021 100	330 mm
393 530 069	393 500 069	393 501 100	393 031 100	330 mm
393 510 169	393 500 169	393 501 300	393 011 100	360 mm
393 520 169	393 500 169	393 501 300	393 021 100	360 mm
393 530 169	393 500 169	393 501 300	393 031 100	360 mm
394 510 069	394 500 069	394 501 200	393 011 100	450 mm
394 520 069	394 500 069	394 501 200	393 021 100	450 mm
394 530 069	394 500 069	394 501 200	393 031 100	450 mm



### Ø 5 mm Atraumatic grasping forceps, with wavy teeth and reservoir

Single action jaws

Complete instrument	Insert	Tube	Handle	Length
393 510 028	393 500 028	393 501 100	393 011 100	330 mm
393 520 028	393 500 028	393 501 100	393 021 100	330 mm
393 530 028	393 500 028	393 501 100	393 031 100	330 mm
393 510 128	393 500 128	393 501 300	393 011 100	360 mm
393 520 128	393 500 128	393 501 300	393 021 100	360 mm
393 530 128	393 500 128	393 501 300	393 031 100	360 mm
394 510 028	394 500 028	394 501 200	393 011 100	450 mm
394 520 028	394 500 028	394 501 200	393 021 100	450 mm
394 530 028	394 500 028	394 501 200	393 031 100	450 mm



### Ø 5 mm Atraumatic grasping forceps, with wavy teeth and reservoir

Double action jaws

Complete instrument	Insert	Tube	Handle	Length
393 510 029	393 500 029	393 501 100	393 011 100	330 mm
393 520 029	393 500 029	393 501 100	393 021 100	330 mm
393 530 029	393 500 029	393 501 100	393 031 100	330 mm
393 510 129	393 500 129	393 501 300	393 011 100	360 mm
393 520 129	393 500 129	393 501 300	393 021 100	360 mm
393 530 129	393 500 129	393 501 300	393 031 100	360 mm
394 510 029	394 500 029	394 501 200	393 011 100	450 mm
394 520 029	394 500 029	394 501 200	393 021 100	450 mm
394 530 029	394 500 029	394 501 200	393 031 100	450 mm

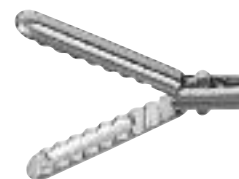

## Instrumentation Ø 5mm

### Ø 5 mm Grasping forceps with reservoir, blunt

Double action jaws



Complete instrument	Insert	Tube	Handle	Length
393 510 010	393 500 010	393 501 100	393 011 100	330 mm
393 520 010	393 500 010	393 501 100	393 021 100	330 mm
393 530 010	393 500 010	393 501 100	393 031 100	330 mm
393 510 110	393 500 110	393 501 300	393 011 100	360 mm
393 520 110	393 500 110	393 501 300	393 021 100	360 mm
393 530 110	393 500 110	393 501 300	393 031 100	360 mm
394 510 010	394 500 010	394 501 200	393 011 100	450 mm
394 520 010	394 500 010	394 501 200	393 021 100	450 mm
394 530 010	394 500 010	394 501 200	393 031 100	450 mm

### Ø 5 mm Grasping forceps with reservoir, sharp

Double action jaws



Complete instrument	Insert	Tube	Handle	Length
393 510 011	393 500 011	393 501 100	393 011 100	330 mm
393 520 011	393 500 011	393 501 100	393 021 100	330 mm
393 530 011	393 500 011	393 501 100	393 031 100	330 mm
393 510 111	393 500 111	393 501 300	393 011 100	360 mm
393 520 111	393 500 111	393 501 300	393 021 100	360 mm
393 530 111	393 500 111	393 501 300	393 031 100	360 mm
394 510 011	394 500 011	394 501 200	393 011 100	450 mm
394 520 011	394 500 011	394 501 200	393 021 100	450 mm
394 530 011	394 500 011	394 501 200	393 031 100	450 mm

### Ø 5 mm Dissecting forceps, fenestrated, slim

Double action jaws



Complete instrument	Insert	Tube	Handle	Length
393 510 031	393 500 031	393 501 100	393 011 100	330 mm
393 520 031	393 500 031	393 501 100	393 021 100	330 mm
393 530 031	393 500 031	393 501 100	393 031 100	330 mm
393 510 131	393 500 131	393 501 300	393 011 100	360 mm
393 520 131	393 500 131	393 501 300	393 021 100	360 mm
393 530 131	393 500 131	393 501 300	393 031 100	360 mm
394 510 031	394 500 031	394 501 200	393 011 100	450 mm
394 520 031	394 500 031	394 501 200	393 021 100	450 mm
394 530 031	394 500 031	394 501 200	393 031 100	450 mm



## Instrumentation Ø 5 mm

### Ø 5 mm Dissecting forceps fenestrated

Double action jaws



Complete instrument	Insert	Tube	Handle	Length
393 510 033	393 500 033	393 501 100	393 011 100	330 mm
393 520 033	393 500 033	393 501 100	393 021 100	330 mm
393 530 033	393 500 033	393 501 100	393 031 100	330 mm
393 510 133	393 500 133	393 501 300	393 011 100	360 mm
393 520 133	393 500 133	393 501 300	393 021 100	360 mm
393 530 133	393 500 133	393 501 300	393 031 100	360 mm
394 510 033	394 500 033	394 501 200	393 011 100	450 mm
394 520 033	394 500 033	394 501 200	393 021 100	450 mm
394 530 033	394 500 033	394 501 200	393 031 100	450 mm

### Ø 5 mm Dissecting forceps fenestrated

Double action jaws



Complete instrument	Insert	Tube	Handle	Length
393 510 034	393 500 034	393 501 100	393 011 100	330 mm
393 520 034	393 500 034	393 501 100	393 021 100	330 mm
393 530 034	393 500 034	393 501 100	393 031 100	330 mm
393 510 134	393 500 134	393 501 300	393 011 100	360 mm
393 520 134	393 500 134	393 501 300	393 021 100	360 mm
393 530 134	393 500 134	393 501 300	393 031 100	360 mm
394 510 034	394 500 034	394 501 200	393 011 100	450 mm
394 520 034	394 500 034	394 501 200	393 021 100	450 mm
394 530 034	394 500 034	394 501 200	393 031 100	450 mm

### Ø 5 mm Duck-Bill grasping forceps fenestrated

Single action jaws



Complete instrument	Insert	Tube	Handle	Length
393 510 035	393 500 035	393 501 100	393 011 100	330 mm
393 520 035	393 500 035	393 501 100	393 021 100	330 mm
393 530 035	393 500 035	393 501 100	393 031 100	330 mm
393 510 135	393 500 135	393 501 300	393 011 100	360 mm
393 520 135	393 500 135	393 501 300	393 021 100	360 mm
393 530 135	393 500 135	393 501 300	393 031 100	360 mm
394 510 035	394 500 035	394 501 200	393 011 100	450 mm
394 520 035	394 500 035	394 501 200	393 021 100	450 mm
394 530 035	394 500 035	394 501 200	393 031 100	450 mm

## Instrumentation Ø 5mm

### Ø 5 mm Dorsey grasping forceps fenestrated

Jaw length 20 mm  
Double action jaws



Complete instrument	Insert	Tube	Handle	Length
393 510 032	393 500 032	393 501 100	393 011 100	330 mm
393 520 032	393 500 032	393 501 100	393 021 100	330 mm
393 530 032	393 500 032	393 501 100	393 031 100	330 mm
393 510 132	393 500 132	393 501 300	393 011 100	360 mm
393 520 132	393 500 132	393 501 300	393 021 100	360 mm
393 530 132	393 500 132	393 501 300	393 031 100	360 mm
394 510 032	394 500 032	394 501 200	393 011 100	450 mm
394 520 032	394 500 032	394 501 200	393 021 100	450 mm
394 530 032	394 500 032	394 501 200	393 031 100	450 mm

### Ø 5 mm Dorsey grasping forceps fenestrated

Jaw length 20 mm  
Single action jaws

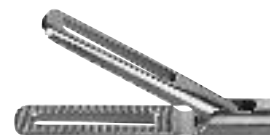

Complete instrument	Insert	Tube	Handle	Length
393 510 036	393 500 036	393 501 100	393 011 100	330 mm
393 520 036	393 500 036	393 501 100	393 021 100	330 mm
393 530 036	393 500 036	393 501 100	393 031 100	330 mm
393 510 136	393 500 136	393 501 300	393 011 100	360 mm
393 520 136	393 500 136	393 501 300	393 021 100	360 mm
393 530 136	393 500 136	393 501 300	393 031 100	360 mm
394 510 036	394 500 036	394 501 200	393 011 100	450 mm
394 520 036	394 500 036	394 501 200	393 021 100	450 mm
394 530 036	394 500 036	394 501 200	393 031 100	450 mm

### Ø 5 mm Dorsey grasping forceps fenestrated

Jaw length 40 mm  
Double action jaws



Complete instrument	Insert	Tube	Handle	Length
393 510 039	393 500 039	393 501 100	393 011 100	330 mm
393 520 039	393 500 039	393 501 100	393 021 100	330 mm
393 530 039	393 500 039	393 501 100	393 031 100	330 mm
393 510 139	393 500 139	393 501 300	393 011 100	360 mm
393 520 139	393 500 139	393 501 300	393 021 100	360 mm
393 530 139	393 500 139	393 501 300	393 031 100	360 mm
394 510 039	394 500 039	394 501 200	393 011 100	450 mm
394 520 039	394 500 039	394 501 200	393 021 100	450 mm
394 530 039	394 500 039	394 501 200	393 031 100	450 mm

## Instrumentation Ø 5 mm

### Ø 5 mm Mixer grasping forceps 90°

Double action jaws



Complete instrument	Insert	Tube	Handle	Length
393 510 008	393 500 008	393 501 100	393 011 100	330 mm
393 520 008	393 500 008	393 501 100	393 021 100	330 mm
393 530 008	393 500 008	393 501 100	393 031 100	330 mm
393 510 108	393 500 108	393 501 300	393 011 100	360 mm
393 520 108	393 500 108	393 501 300	393 021 100	360 mm
393 530 108	393 500 108	393 501 300	393 031 100	360 mm
394 510 008	394 500 008	394 501 200	393 011 100	450 mm
394 520 008	394 500 008	394 501 200	393 021 100	450 mm
394 530 008	394 500 008	394 501 200	393 031 100	450 mm

### Ø 5 mm Mixer grasping forceps 45°

Double action jaws



Complete instrument	Insert	Tube	Handle	Length
393 510 077	393 500 077	393 501 100	393 011 100	330 mm
393 520 077	393 500 077	393 501 100	393 021 100	330 mm
393 530 077	393 500 077	393 501 100	393 031 100	330 mm
393 510 177	393 500 177	393 501 300	393 011 100	360 mm
393 520 177	393 500 177	393 501 300	393 021 100	360 mm
393 530 177	393 500 177	393 501 300	393 031 100	360 mm
394 510 077	394 500 077	394 501 200	393 011 100	450 mm
394 520 077	394 500 077	394 501 200	393 021 100	450 mm
394 530 077	394 500 077	394 501 200	393 031 100	450 mm

### Ø 5 mm Grasping forceps with De Bakey teeth

Double action jaws



Complete instrument	Insert	Tube	Handle	Length
393 510 038	393 500 038	393 501 100	393 011 100	330 mm
393 520 038	393 500 038	393 501 100	393 021 100	330 mm
393 530 038	393 500 038	393 501 100	393 031 100	330 mm
393 510 138	393 500 138	393 501 300	393 011 100	360 mm
393 520 138	393 500 138	393 501 300	393 021 100	360 mm
393 530 138	393 500 138	393 501 300	393 031 100	360 mm
394 510 038	394 500 038	394 501 200	393 011 100	450 mm
394 520 038	394 500 038	394 501 200	393 021 100	450 mm
394 530 038	394 500 038	394 501 200	393 031 100	450 mm

# 4 Dissecting and grasping forceps

Company

Optics

Trocars

Dissecting and grasping forceps

Scissors biopsy forceps

Instruments for coagulation

Divers accessories

Suture and ligature

Sterilization and maintenance

## Instrumentation Ø 5 mm

### Ø 5 mm De Bakey clamp

Jaw length 30 mm  
Double action jaws

Complete instrument	Insert	Tube	Handle	Length
393 510 037	393 500 037	393 501 100	393 011 100	330 mm
393 520 037	393 500 037	393 501 100	393 021 100	330 mm
393 530 037	393 500 037	393 501 100	393 031 100	330 mm
393 510 137	393 500 137	393 501 300	393 011 100	360 mm
393 520 137	393 500 137	393 501 300	393 021 100	360 mm
393 530 137	393 500 137	393 501 300	393 031 100	360 mm
394 510 037	394 500 037	394 501 200	393 011 100	450 mm
394 520 037	394 500 037	394 501 200	393 021 100	450 mm
394 530 037	394 500 037	394 501 200	393 031 100	450 mm



### Ø 5 mm Babcock clamp

Double action jaws

Complete instrument	Insert	Tube	Handle	Length
393 510 045	393 500 045	393 501 100	393 011 100	330 mm
393 520 045	393 500 045	393 501 100	393 021 100	330 mm
393 530 045	393 500 045	393 501 100	393 031 100	330 mm
393 510 145	393 500 145	393 501 300	393 011 100	360 mm
393 520 145	393 500 145	393 501 300	393 021 100	360 mm
393 530 145	393 500 145	393 501 300	393 031 100	360 mm
394 510 045	394 500 045	394 501 200	393 011 100	450 mm
394 520 045	394 500 045	394 501 200	393 021 100	450 mm
394 530 045	394 500 045	394 501 200	393 031 100	450 mm



### Ø 5 mm Maxigrip grasping forceps

Double action jaws

Complete instrument	Insert	Tube	Handle	Length
393 510 070	393 500 070	393 501 100	393 011 100	330 mm
393 520 070	393 500 070	393 501 100	393 021 100	330 mm
393 530 070	393 500 070	393 501 100	393 031 100	330 mm
393 510 170	393 500 170	393 501 300	393 011 100	360 mm
393 520 170	393 500 170	393 501 300	393 021 100	360 mm
393 530 170	393 500 170	393 501 300	393 031 100	360 mm
394 510 070	394 500 070	394 501 200	393 011 100	450 mm
394 520 070	394 500 070	394 501 200	393 021 100	450 mm
394 530 070	394 500 070	394 501 200	393 031 100	450 mm



## Instrumentation Ø 5 mm

### Ø 5 mm Grasping forceps

2 + 4 teeth  
Single action jaws



Complete instrument	Insert	Tube	Handle	Length
393 510 071	393 500 071	393 501 100	393 011 100	330 mm
393 520 071	393 500 071	393 501 100	393 021 100	330 mm
393 530 071	393 500 071	393 501 100	393 031 100	330 mm
393 510 171	393 500 171	393 501 300	393 011 100	360 mm
393 520 171	393 500 171	393 501 300	393 021 100	360 mm
393 530 171	393 500 171	393 501 300	393 031 100	360 mm
394 510 071	394 500 071	394 501 200	393 011 100	450 mm
394 520 071	394 500 071	394 501 200	393 021 100	450 mm
394 530 071	394 500 071	394 501 200	393 031 100	450 mm

### Ø 5 mm Grasping forceps distal with row of teeth

Double action jaws



Complete instrument	Insert	Tube	Handle	Length
393 510 072	393 500 072	393 501 100	393 011 100	330 mm
393 520 072	393 500 072	393 501 100	393 021 100	330 mm
393 530 072	393 500 072	393 501 100	393 031 100	330 mm
393 510 172	393 500 172	393 501 300	393 011 100	360 mm
393 520 172	393 500 172	393 501 300	393 021 100	360 mm
393 530 172	393 500 172	393 501 300	393 031 100	360 mm
394 510 072	394 500 072	394 501 200	393 011 100	450 mm
394 520 072	394 500 072	394 501 200	393 021 100	450 mm
394 530 072	394 500 072	394 501 200	393 031 100	450 mm

### Ø 5 mm Grasping forceps

Double action jaws



Complete instrument	Insert	Tube	Handle	Length
393 510 073	393 500 073	393 501 100	393 011 100	330 mm
393 520 073	393 500 073	393 501 100	393 021 100	330 mm
393 530 073	393 500 073	393 501 100	393 031 100	330 mm
393 510 173	393 500 173	393 501 300	393 011 100	360 mm
393 520 173	393 500 173	393 501 300	393 021 100	360 mm
393 530 173	393 500 173	393 501 300	393 031 100	360 mm
394 510 073	394 500 073	394 501 200	393 011 100	450 mm
394 520 073	394 500 073	394 501 200	393 021 100	450 mm
394 530 073	394 500 073	394 501 200	393 031 100	450 mm

## Instrumentation Ø 5 mm

### Ø 5 mm Grasping forceps with fine crosswise teeth

Double action jaws

Complete instrument	Insert	Tube	Handle	Length
393 510 074	393 500 074	393 501 100	393 011 100	330 mm
393 520 074	393 500 074	393 501 100	393 021 100	330 mm
393 530 074	393 500 074	393 501 100	393 031 100	330 mm
393 510 174	393 500 174	393 501 300	393 011 100	360 mm
393 520 174	393 500 174	393 501 300	393 021 100	360 mm
393 530 174	393 500 174	393 501 300	393 031 100	360 mm
394 510 074	394 500 074	394 501 200	393 011 100	450 mm
394 520 074	394 500 074	394 501 200	393 021 100	450 mm
394 530 074	394 500 074	394 501 200	393 031 100	450 mm



### Ø 5 mm Grasping forceps with mouse teeth

Double action jaws

Complete instrument	Insert	Tube	Handle	Length
393 510 075	393 500 075	393 501 100	393 011 100	330 mm
393 520 075	393 500 075	393 501 100	393 021 100	330 mm
393 530 075	393 500 075	393 501 100	393 031 100	330 mm
393 510 175	393 500 175	393 501 300	393 011 100	360 mm
393 520 175	393 500 175	393 501 300	393 021 100	360 mm
393 530 175	393 500 175	393 501 300	393 031 100	360 mm
394 510 075	394 500 075	394 501 200	393 011 100	450 mm
394 520 075	394 500 075	394 501 200	393 021 100	450 mm
394 530 075	394 500 075	394 501 200	393 031 100	450 mm



### Ø 5 mm Grasping forceps with mouse teeth

Single action jaws

Complete instrument	Insert	Tube	Handle	Length
393 510 076	393 500 076	393 501 100	393 011 100	330 mm
393 520 076	393 500 076	393 501 100	393 021 100	330 mm
393 530 076	393 500 076	393 501 100	393 031 100	330 mm
393 510 176	393 500 176	393 501 300	393 011 100	360 mm
393 520 176	393 500 176	393 501 300	393 021 100	360 mm
393 530 176	393 500 176	393 501 300	393 031 100	360 mm
394 510 076	394 500 076	394 501 200	393 011 100	450 mm
394 520 076	394 500 076	394 501 200	393 021 100	450 mm
394 530 076	394 500 076	394 501 200	393 031 100	450 mm



## Instrumentation Ø 5 mm

### Ø 5 mm Tenaculum grasping forceps

Double action jaws



Complete instrument	Insert	Tube	Handle	Length
393 510 078	393 500 078	393 501 100	393 011 100	330 mm
393 520 078	393 500 078	393 501 100	393 021 100	330 mm
393 530 078	393 500 078	393 501 100	393 031 100	330 mm
393 510 178	393 500 178	393 501 300	393 011 100	360 mm
393 520 178	393 500 178	393 501 300	393 021 100	360 mm
393 530 178	393 500 178	393 501 300	393 031 100	360 mm
394 510 078	394 500 078	394 501 200	393 011 100	450 mm
394 520 078	394 500 078	394 501 200	393 021 100	450 mm
394 530 078	394 500 078	394 501 200	393 031 100	450 mm

### Ø 5 mm Aggressiv claw grasping forceps

Double action jaws



Complete instrument	Insert	Tube	Handle	Length
393 510 079	393 500 079	393 501 100	393 011 100	330 mm
393 520 079	393 500 079	393 501 100	393 021 100	330 mm
393 530 079	393 500 079	393 501 100	393 031 100	330 mm
393 510 179	393 500 179	393 501 300	393 011 100	360 mm
393 520 179	393 500 179	393 501 300	393 021 100	360 mm
393 530 179	393 500 179	393 501 300	393 031 100	360 mm
394 510 079	394 500 079	394 501 200	393 011 100	450 mm
394 520 079	394 500 079	394 501 200	393 021 100	450 mm
394 530 079	394 500 079	394 501 200	393 031 100	450 mm

### Ø 5 mm Alligator grasping forceps

Double action jaws



Complete instrument	Insert	Tube	Handle	Length
393 510 015	393 500 015	393 501 100	393 011 100	330 mm
393 520 015	393 500 015	393 501 100	393 021 100	330 mm
393 530 015	393 500 015	393 501 100	393 031 100	330 mm
393 510 115	393 500 115	393 501 300	393 011 100	360 mm
393 520 115	393 500 115	393 501 300	393 021 100	360 mm
393 530 115	393 500 115	393 501 300	393 031 100	360 mm
394 510 015	394 500 015	394 501 200	393 011 100	450 mm
394 520 015	394 500 015	394 501 200	393 021 100	450 mm
394 530 015	394 500 015	394 501 200	393 031 100	450 mm

# 4 Dissecting and grasping forceps

Company

Optics

Trocars

Dissecting and grasping forceps

Scissors biopsy forceps

Instruments for coagulation

Divers accessories

Suture and ligature

Sterilization and maintenance

## Instrumentation Ø 5 mm

### Ø 5mm Wave grasping forceps fenestrated

Double action jaws

Complete instrument	Insert	Tube	Handle	Length
393 510 080	393 500 080	393 501 100	393 011 100	330 mm
393 520 080	393 500 080	393 501 100	393 021 100	330 mm
393 530 080	393 500 080	393 501 100	393 031 100	330 mm
393 510 180	393 500 180	393 501 300	393 011 100	360 mm
393 520 180	393 500 180	393 501 300	393 021 100	360 mm
393 530 180	393 500 180	393 501 300	393 031 100	360 mm
394 510 080	394 500 080	394 501 200	393 011 100	450 mm
394 520 080	394 500 080	394 501 200	393 021 100	450 mm
394 530 080	394 500 080	394 501 200	393 031 100	450 mm





## Instrumentation Ø 10 mm

### Ø 10 mm Claw grasping and extracting forceps

2 + 3 teeth  
Single action jaws

Complete instrument	Insert	Tube	Handle	Length
393 910 001	393 900 001	393 901 100	393 011 100	330 mm
393 920 001	393 900 001	393 901 100	393 021 100	330 mm
393 930 001	393 900 001	393 901 100	393 031 100	330 mm
393 910 101	393 900 101	393 901 200	393 011 100	360 mm
393 920 101	393 900 101	393 901 200	393 021 100	360 mm
393 930 101	393 900 101	393 901 200	393 031 100	360 mm
393 910 201	393 900 201	394 901 200	393 011 100	450 mm
393 920 201	393 900 201	394 901 200	393 021 100	450 mm
393 930 201	393 900 201	394 901 200	393 031 100	450 mm



### Ø 10 mm Maryland grasping forceps

Double action jaws

Complete instrument	Insert	Tube	Handle	Length
393 910 042	393 900 042	393 901 100	393 011 100	330 mm
393 920 042	393 900 042	393 901 100	393 021 100	330 mm
393 930 042	393 900 042	393 901 100	393 031 100	330 mm
393 910 142	393 900 142	393 901 200	393 011 100	360 mm
393 920 142	393 900 142	393 901 200	393 021 100	360 mm
393 930 142	393 900 142	393 901 200	393 031 100	360 mm
393 910 242	393 901 242	394 901 200	393 011 100	450 mm
393 920 242	393 901 242	394 901 200	393 021 100	450 mm
393 930 242	393 901 242	394 901 200	393 031 100	450 mm



### Ø 10 mm Mixter grasping forceps

Double action jaws

Complete instrument	Insert	Tube	Handle	Length
393 910 008	393 900 008	393 901 100	393 011 100	330 mm
393 920 008	393 900 008	393 901 100	393 021 100	330 mm
393 930 008	393 900 008	393 901 100	393 031 100	330 mm
393 910 108	393 900 108	393 901 200	393 011 100	360 mm
393 920 108	393 900 108	393 901 200	393 021 100	360 mm
393 930 108	393 900 108	393 901 200	393 031 100	360 mm
393 910 208	393 901 208	394 901 200	393 011 100	450 mm
393 920 208	393 901 208	394 901 200	393 021 100	450 mm
393 930 208	393 901 208	394 901 200	393 031 100	450 mm



# 4 Dissecting and grasping forceps

Company

Optics

Trocars

Dissecting and grasping forceps

Scissors biopsy forceps

Instruments for coagulation

Divers accessories

Suture and ligature

Sterilization and maintenance

## Instrumentation Ø 10 mm

### Ø 10 mm Dorsey grasping forceps

Double action jaws

Complete instrument	Insert	Tube	Handle	Length
393 910 032	393 900 032	393 901 100	393 011 100	330 mm
393 920 032	393 900 032	393 901 100	393 021 100	330 mm
393 930 032	393 900 032	393 901 100	393 031 100	330 mm
393 910 132	393 900 132	393 901 200	393 011 100	360 mm
393 920 132	393 900 132	393 901 200	393 021 100	360 mm
393 930 132	393 900 132	393 901 200	393 031 100	360 mm
393 910 232	393 901 232	394 901 200	393 011 100	450 mm
393 920 232	393 901 232	394 901 200	393 021 100	450 mm
393 930 232	393 901 232	394 901 200	393 031 100	450 mm



### Ø 10 mm Grasping forceps with De Bakey teeth, fenestrated

Double action jaws

Complete instrument	Insert	Tube	Handle	Length
393 910 038	393 900 038	393 901 100	393 011 100	330 mm
393 920 038	393 900 038	393 901 100	393 021 100	330 mm
393 930 038	393 900 038	393 901 100	393 031 100	330 mm
393 910 138	393 900 138	393 901 200	393 011 100	360 mm
393 920 138	393 900 138	393 901 200	393 021 100	360 mm
393 930 138	393 900 138	393 901 200	393 031 100	360 mm
393 910 238	393 901 238	394 901 200	393 011 100	450 mm
393 920 238	393 901 238	394 901 200	393 021 100	450 mm
393 930 238	393 901 238	394 901 200	393 031 100	450 mm



### Ø 10 mm Babcock grasping forceps, with crosswise teeth

Double action jaws

Complete instrument	Insert	Tube	Handle	Length
393 910 074	393 900 074	393 901 100	393 011 100	330 mm
393 920 074	393 900 074	393 901 100	393 021 100	330 mm
393 930 074	393 900 074	393 901 100	393 031 100	330 mm
393 910 174	393 900 174	393 901 200	393 011 100	360 mm
393 920 174	393 900 174	393 901 200	393 021 100	360 mm
393 930 174	393 900 174	393 901 200	393 031 100	360 mm
393 910 274	393 901 274	394 901 200	393 011 100	450 mm
393 920 274	393 901 274	394 901 200	393 021 100	450 mm
393 930 274	393 901 274	394 901 200	393 031 100	450 mm



## Instrumentation Ø 10 mm

### Ø 10 mm De Bakey clamp, double teeth

Jaw length 40 mm  
Double action jaws

Complete instrument	Insert	Tube	Handle	Length
393 910 037	393 900 037	393 901 100	393 011 100	330 mm
393 920 037	393 900 037	393 901 100	393 021 100	330 mm
393 930 037	393 900 037	393 901 100	393 031 100	330 mm
393 910 137	393 900 137	393 901 200	393 011 100	360 mm
393 920 137	393 900 137	393 901 200	393 021 100	360 mm
393 930 137	393 900 137	393 901 200	393 031 100	360 mm
393 910 237	393 901 237	394 901 200	393 011 100	450 mm
393 920 237	393 901 237	394 901 200	393 021 100	450 mm
393 930 237	393 901 237	394 901 200	393 031 100	450 mm



### Ø 10 mm Babcock clamp

Double action jaws

Complete instrument	Insert	Tube	Handle	Length
393 910 045	393 900 045	393 901 100	393 011 100	330 mm
393 920 045	393 900 045	393 901 100	393 021 100	330 mm
393 930 045	393 900 045	393 901 100	393 031 100	330 mm
393 910 145	393 900 145	393 901 200	393 011 100	360 mm
393 920 145	393 900 145	393 901 200	393 021 100	360 mm
393 930 145	393 900 145	393 901 200	393 031 100	360 mm
393 910 245	393 901 245	394 901 200	393 011 100	450 mm
393 920 245	393 901 245	394 901 200	393 021 100	450 mm
393 930 245	393 901 245	394 901 200	393 031 100	450 mm



### Ø 10 mm Babcock grasping forceps

Double action jaws

Complete instrument	Insert	Tube	Handle	Length
393 910 073	393 900 073	393 901 100	393 011 100	330 mm
393 920 073	393 900 073	393 901 100	393 021 100	330 mm
393 930 073	393 900 073	393 901 100	393 031 100	330 mm
393 910 173	393 900 173	393 901 200	393 011 100	360 mm
393 920 173	393 900 173	393 901 200	393 021 100	360 mm
393 930 173	393 900 173	393 901 200	393 031 100	360 mm
393 910 273	393 901 273	394 901 200	393 011 100	450 mm
393 920 273	393 901 273	394 901 200	393 021 100	450 mm
393 930 273	393 901 273	394 901 200	393 031 100	450 mm



# 4 Dissecting and grasping forceps

Company

Optics

Trocars

Dissecting and grasping forceps

Scissors biopsy forceps

Instruments for coagulation

Divers accessories

Suture and ligature

Sterilization and maintenance

## Instrumentation Ø 10 mm

### Ø 10 mm Collin clamp

Double action jaws

Complete instrument	Insert	Tube	Handle	Length
393 910 035	393 900 035	393 901 100	393 011 100	330 mm
393 920 035	393 900 035	393 901 100	393 021 100	330 mm
393 930 035	393 900 035	393 901 100	393 031 100	330 mm
393 910 135	393 900 135	393 901 200	393 011 100	360 mm
393 920 135	393 900 135	393 901 200	393 021 100	360 mm
393 930 135	393 900 135	393 901 200	393 031 100	360 mm
393 910 235	393 901 235	394 901 200	393 011 100	450 mm
393 920 235	393 901 235	394 901 200	393 021 100	450 mm
393 930 235	393 901 235	394 901 200	393 031 100	450 mm



### Ø 10 mm Pennington

Double action jaws

Complete instrument	Insert	Tube	Handle	Length
393 910 031	393 900 031	393 901 100	393 011 100	330 mm
393 920 031	393 900 031	393 901 100	393 021 100	330 mm
393 930 031	393 900 031	393 901 100	393 031 100	330 mm
393 910 131	393 900 131	393 901 200	393 011 100	360 mm
393 920 131	393 900 131	393 901 200	393 021 100	360 mm
393 930 131	393 900 131	393 901 200	393 031 100	360 mm
393 910 231	393 901 231	394 901 200	393 011 100	450 mm
393 920 231	393 901 231	394 901 200	393 021 100	450 mm
393 930 231	393 901 231	394 901 200	393 031 100	450 mm



### Ø 10 mm Claw grasping forceps

2 + 3 teeth

Single action jaws

Complete instrument	Insert	Tube	Handle	Length
393 910 005	393 900 005	393 901 100	393 011 100	330 mm
393 920 005	393 900 005	393 901 100	393 021 100	330 mm
393 930 005	393 900 005	393 901 100	393 031 100	330 mm
393 910 105	393 900 105	393 901 200	393 011 100	360 mm
393 920 105	393 900 105	393 901 200	393 021 100	360 mm
393 930 105	393 900 105	393 901 200	393 031 100	360 mm
393 910 205	393 900 205	394 901 200	393 011 100	450 mm
393 920 205	393 900 205	394 901 200	393 021 100	450 mm
393 930 205	393 900 205	394 901 200	393 031 100	450 mm



## Instrumentation Ø 10 mm

### Ø 10 mm Claw with fine teeth, curved

Complete instrument	Insert	Tube	Handle	Length
393 910 043	393 900 043	393 901 100	393 011 100	330 mm
393 920 043	393 900 043	393 901 100	393 021 100	330 mm
393 930 043	393 900 043	393 901 100	393 031 100	330 mm
393 910 143	393 900 143	393 901 200	393 011 100	360 mm
393 920 143	393 900 143	393 901 200	393 021 100	360 mm
393 930 143	393 900 143	393 901 200	393 031 100	360 mm
393 910 243	393 900 243	394 901 200	393 011 100	450 mm
393 920 243	393 900 243	394 901 200	393 021 100	450 mm
393 930 243	393 900 243	394 901 200	393 031 100	450 mm



### Ø 10 mm Tenaculum forceps

Complete instrument	Insert	Tube	Handle	Length
393 910 078	393 900 078	393 901 100	393 011 100	330 mm
393 920 078	393 900 078	393 901 100	393 021 100	330 mm
393 930 078	393 900 078	393 901 100	393 031 100	330 mm
393 910 178	393 900 178	393 901 200	393 011 100	360 mm
393 920 178	393 900 178	393 901 200	393 021 100	360 mm
393 930 178	393 900 178	393 901 200	393 031 100	360 mm
393 910 278	393 900 278	394 901 200	393 011 100	450 mm
393 920 278	393 900 278	394 901 200	393 021 100	450 mm
393 930 278	393 900 278	394 901 200	393 031 100	450 mm



## Monopolar cables

Art.-No.  
**395 502 500**

### Monopolar High frequency cable

3m length  
For SOPRO-COMEG monopolar electrodes and forceps  
To connect with electro surgery units model ERBE T-serie

Art.-No.  
**395 502 502**

### Monopolar High frequency cable

3m length  
For SOPRO-COMEG monopolar electrodes and forceps  
To connect with electro surgery units model ERBE ACC and ICC



Art.-No.  
**395 502 501**

### Monopolar High frequency cable

5m length  
For SOPRO-COMEG monopolar electrodes and forceps  
to connect with electro surgery units model ERBE T-serie

Art.-No.  
**395 502 503**

### Monopolar High frequency cable

3m length  
For SOPRO-COMEG monopolar electrodes and forceps  
To connect with electro surgery units model MARTIN and BERCHTOLD

Art.-No.  
**395 502 504**

### Monopolar High frequency cable

5m length  
For SOPRO-COMEG monopolar electrodes and forceps  
To connect with electro surgery units model MARTIN and BERCHTOLD



Art.-No.  
**395 502 505**

### Monopolar High frequency cable

3m length  
For SOPRO-COMEG monopolar electrodes and forceps  
To connect with electro surgery units model VALLEYLAB and CONMED

Art.-No.  
**395 502 506**

### Monopolar High frequency cable

5m length  
For SOPRO-COMEG monopolar electrodes and forceps  
To connect with electro surgery units model VALLEYLAB and CONMED



Art.-No.  
**395 502 507**

### Monopolar High frequency cable

3m length  
For SOPRO-COMEG monopolar electrodes and forceps  
To connect with electro surgery units model VARIOUS GENERATORS

Art.-No.  
**395 502 508**

### Monopolar High frequency cable

5m length  
For SOPRO-COMEG monopolar electrodes and forceps  
To connect with electro surgery units model VARIOUS GENERATORS





SOPRO  
COMEG

The logo features two curved, swoosh-like shapes. The top swoosh is light green and curves from the right side towards the center. The bottom swoosh is light blue and curves from the left side towards the center. The text 'SOPRO' and 'COMEG' is centered between these two swooshes.

**SOPRO**  
**COMEG**



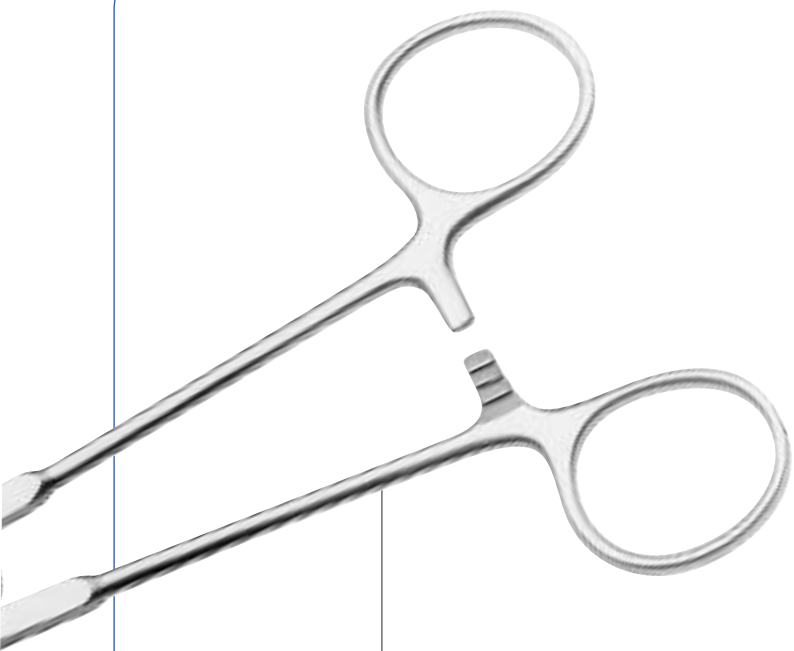

## **5 • SCISSORS, BIOPSY FORCEPS**

Plastic handles . . . . .	p70
Metal handles . . . . .	p71
Tube shafts . . . . .	p72
Instrumentation Ø 3 mm . . . . .	p73
Instrumentation Ø 5 mm . . . . .	p75
Instrumentation Ø 10 mm . . . . .	p78
Monopolar cables . . . . .	p79

## Plastic handles

Art.-No.  
**393 011 100**

**Ergonomic highly rigid plastic ring handle with rotation module and HF connection**



Art.-No.  
**393 021 100**

**Ergonomic highly rigid plastic ring handle with ratchet, rotation module and HF connection**



Art.-No.  
**393 031 100**

**Ergonomic highly rigid plastic ring handle with stepless ratchet, ratchet releasing key, rotation module and HF connection**



## Metal handles

Art.-No.

**393 041 100**

**Axial ring handle, with ratchet**

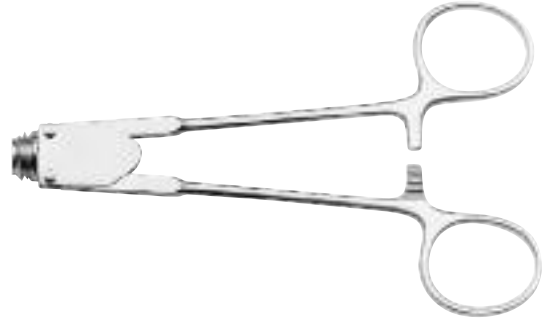

Art.-No.

**393 051 100**

**Axial handle, with spreading spring and ratchet**

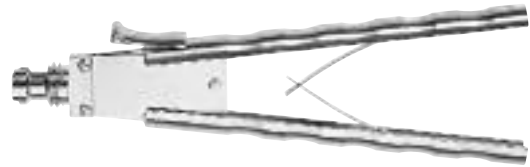

Art.-No.

**393 061 100**

**Axial handle, with spreading spring**

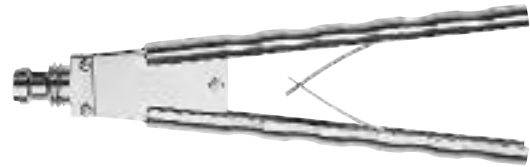

Company

Optics

Trocars

Dissecting and grasping forceps

Scissors biopsy forceps

Instruments for coagulation

Divers accessories

Suture and ligature

Sterilization and maintenance

## Tube shafts



Art.-No.  
**393 501 100**

**Ø 5 mm Tube shaft insulated**  
With Luer-Lock  
Length 330 mm

Art.-No.  
**393 501 300**

**Ø 5 mm Tube shaft insulated**  
With Luer-Lock  
Length 360 mm

Art.-No.  
**394 501 200**

**Ø 5 mm Tube shaft insulated**  
With Luer-Lock  
Length 450 mm



Art.-No.  
**393 901 100**

**Ø 10 mm Tube shaft insulated**  
With Luer-Lock  
Length 330 mm

Art.-No.  
**393 901 200**

**Ø 10 mm Tube shaft insulated**  
With Luer-Lock  
Length 360 mm

Art.-No.  
**394 901 200**

**Ø 10 mm Tube shaft insulated**  
With Luer-Lock  
Length 450 mm

## Instrumentation Ø 3 mm

### Ø 3 mm Metzenbaum scissors, straight

Double action jaws

Complete instrument	Insert	Handle	Length
393 310 150	393 300 150	393 011 100	180 mm
393 360 150	393 300 150	393 061 100	180 mm
393 310 050	393 300 050	393 011 100	210 mm
393 360 050	393 300 050	393 061 100	210 mm
393 310 250	393 300 250	393 011 100	330 mm
393 360 250	393 300 250	393 061 100	330 mm



### Ø 3 mm Peritoneal scissors, straight

Single action jaws

Complete instrument	Insert	Handle	Length
393 310 161	393 300 161	393 011 100	180 mm
393 360 161	393 300 161	393 061 100	180 mm
393 310 061	393 300 061	393 011 100	210 mm
393 360 061	393 300 061	393 061 100	210 mm
393 310 261	393 300 261	393 011 100	330 mm
393 360 261	393 300 261	393 061 100	330 mm



### Ø 3 mm Hook scissors

Single action jaws

Complete instrument	Insert	Handle	Length
393 310 165	393 300 165	393 011 100	180 mm
393 360 165	393 300 165	393 061 100	180 mm
393 310 065	393 300 065	393 011 100	210 mm
393 360 065	393 300 065	393 061 100	210 mm
393 310 265	393 300 265	393 011 100	330 mm
393 360 265	393 300 265	393 061 100	330 mm



### Ø 3 mm Micro scissors straight

Single action jaws

Complete instrument	Insert	Handle	Length
393 310 103	393 300 103	393 011 100	180 mm
393 360 103	393 300 103	393 061 100	180 mm
393 310 003	393 300 003	393 011 100	210 mm
393 360 003	393 300 003	393 061 100	210 mm
393 310 203	393 300 203	393 011 100	330 mm
393 360 203	393 300 203	393 061 100	330 mm



## Instrumentation Ø 3 mm

### Ø 3mm Biopsy cup with thorn

Double action jaws



Complete instrument	Insert	Handle	Length
393 310 106	393 300 106	393 011 100	180 mm
393 320 106	393 300 106	393 021 100	180 mm
393 330 106	393 300 106	393 031 100	180 mm
393 310 006	393 300 006	393 011 100	210 mm
393 320 006	393 300 006	393 021 100	210 mm
393 330 006	393 300 006	393 031 100	210 mm
393 310 206	393 300 206	393 011 100	330 mm
393 320 206	393 300 206	393 021 100	330 mm
393 330 206	393 300 206	393 031 100	330 mm

### Ø 3mm Metzenbaum scissors, curved

Double action jaws



Complete instrument	Insert	Handle	Length
393 310 151	393 300 151	393 011 100	180 mm
393 360 151	393 300 151	393 061 100	180 mm
393 310 051	393 300 051	393 011 100	210 mm
393 360 051	393 300 051	393 061 100	210 mm
393 310 251	393 300 251	393 011 100	330 mm
393 360 251	393 300 251	393 061 100	330 mm

### Ø 3mm Biopsy cup without thorn

Double action jaws



Complete instrument	Insert	Handle	Length
393 310 107	393 300 107	393 011 100	180 mm
393 320 107	393 300 107	393 021 100	180 mm
393 330 107	393 300 107	393 031 100	180 mm
393 310 007	393 300 007	393 011 100	210 mm
393 320 007	393 300 007	393 021 100	210 mm
393 330 007	393 300 007	393 031 100	210 mm
393 310 207	393 300 207	393 011 100	330 mm
393 320 207	393 300 207	393 021 100	330 mm
393 330 207	393 300 207	393 031 100	330 mm

## Instrumentation Ø 5 mm

### Ø 5 mm Metzenbaum scissors, straight

Double action jaws

Complete instrument	Insert	Tube	Handle	Length
393 510 050	393 500 050	393 501 100	393 011 100	330 mm
393 560 050	393 500 050	393 501 100	393 061 100	330 mm
393 510 150	393 500 150	393 501 300	393 011 100	360 mm
393 560 150	393 500 150	393 501 300	393 061 100	360 mm
394 510 050	394 500 050	394 501 200	393 011 100	450 mm
394 560 050	394 500 050	394 501 200	393 061 100	450 mm



### Ø 5 mm Metzenbaum scissors, curved

Double action jaws

Complete instrument	Insert	Tube	Handle	Length
393 510 051	393 500 051	393 501 100	393 011 100	330 mm
393 560 051	393 500 051	393 501 100	393 061 100	330 mm
393 510 151	393 500 151	393 501 300	393 011 100	360 mm
393 560 151	393 500 151	393 501 300	393 061 100	360 mm
394 510 051	394 500 051	394 501 200	393 011 100	450 mm
394 560 051	394 500 051	394 501 200	393 061 100	450 mm



### Ø 5 mm Peritoneal scissors, straight

Single action jaws

Complete instrument	Insert	Tube	Handle	Length
393 510 061	393 500 061	393 501 100	393 011 100	330 mm
393 560 061	393 500 061	393 501 100	393 061 100	330 mm
393 510 161	393 500 161	393 501 300	393 011 100	360 mm
393 560 161	393 500 161	393 501 300	393 061 100	360 mm
394 510 061	394 500 061	394 501 200	393 011 100	450 mm
394 560 061	394 500 061	394 501 200	393 061 100	450 mm



### Ø 5 mm Hook scissors

Single action jaws

Complete instrument	Insert	Tube	Handle	Length
393 510 065	393 500 065	393 501 100	393 011 100	330 mm
393 560 065	393 500 065	393 501 100	393 061 100	330 mm
393 510 165	393 500 165	393 501 300	393 011 100	360 mm
393 560 165	393 500 165	393 501 300	393 061 100	360 mm
394 510 065	394 500 065	394 501 200	393 011 100	450 mm
394 560 065	394 500 065	394 501 200	393 061 100	450 mm



## Instrumentation Ø 5 mm

### Ø 5 mm Micro scissors straight

Single action jaw



Complete instrument	Insert	Tube	Handle	Length
393 510 003	393 500 003	393 501 100	393 011 100	330 mm
393 560 003	393 500 003	393 501 100	393 061 100	330 mm
393 510 103	393 500 103	393 501 300	393 011 100	360 mm
393 560 103	393 500 103	393 501 300	393 061 100	360 mm
394 510 003	394 500 003	394 501 200	393 011 100	450 mm
394 560 003	394 500 003	394 501 200	393 061 100	450 mm

### Ø 5 mm Biopsy cup without thorn

Double action jaws



Complete instrument	Insert	Tube	Handle	Length
393 510 007	393 500 007	393 501 100	393 011 100	330 mm
393 520 007	393 500 007	393 501 100	393 021 100	330 mm
393 530 007	393 500 007	393 501 100	393 031 100	330 mm
393 510 107	393 500 107	393 501 300	393 011 100	360 mm
393 520 107	393 500 107	393 501 300	393 021 100	360 mm
393 530 107	393 500 107	393 501 300	393 031 100	360 mm
394 510 007	394 500 007	394 501 200	393 011 100	450 mm
394 520 007	394 500 007	394 501 200	393 021 100	450 mm
394 530 007	394 500 007	394 501 200	393 031 100	450 mm

### Ø 5 mm Biopsy cup with thorn

Double action jaws



Complete instrument	Insert	Tube	Handle	Length
393 510 006	393 500 006	393 501 100	393 011 100	330 mm
393 520 006	393 500 006	393 501 100	393 021 100	330 mm
393 530 006	393 500 006	393 501 100	393 031 100	330 mm
393 510 106	393 500 106	393 501 300	393 011 100	360 mm
393 520 106	393 500 106	393 501 300	393 021 100	360 mm
393 530 106	393 500 106	393 501 300	393 031 100	360 mm
394 510 006	394 500 006	394 501 200	393 011 100	450 mm
394 520 006	394 500 006	394 501 200	393 021 100	450 mm
394 530 006	394 500 006	394 501 200	393 031 100	450 mm



## Instrumentation Ø 5 mm

### Ø 5 mm Biopsy punch without thorn

Single action jaw



Complete instrument	Insert	Tube	Handle	Length
393 510 068	393 500 068	393 501 100	393 011 100	330 mm
393 520 068	393 500 068	393 501 100	393 021 100	330 mm
393 530 068	393 500 068	393 501 100	393 031 100	330 mm
393 510 168	393 500 168	393 501 300	393 011 100	360 mm
393 520 168	393 500 168	393 501 300	393 021 100	360 mm
393 530 168	393 500 168	393 501 300	393 031 100	360 mm
394 510 068	394 500 068	394 501 200	393 011 100	450 mm
394 520 068	394 500 068	394 501 200	393 021 100	450 mm
394 530 068	394 500 068	394 501 200	393 031 100	450 mm

## Instrumentation Ø 10 mm

### Ø 10 mm Large OP scissors

Single action jaws



Complete instrument	Insert	Tube	Handle	Length
393 910 002	393 900 002	393 901 100	393 011 100	330 mm
393 960 002	393 900 002	393 901 100	393 061 100	330 mm
393 910 102	393 900 102	393 901 200	393 061 100	360 mm
393 960 102	393 900 102	393 901 200	393 061 100	360 mm
393 910 202	393 900 202	394 901 200	393 011 100	450 mm
393 960 202	393 900 202	394 901 200	393 061 100	450 mm

### Ø 10 mm Large cup biopsy forceps

Single action jaws



Complete instrument	Insert	Tube	Handle	Length
393 910 072	393 900 072	393 901 100	393 011 100	330 mm
393 920 072	393 900 072	393 901 100	393 021 100	330 mm
393 930 072	393 900 072	393 901 100	393 031 100	330 mm
393 910 172	393 900 172	393 901 200	393 011 100	360 mm
393 920 172	393 900 172	393 901 200	393 021 100	360 mm
393 930 172	393 900 172	393 901 200	393 031 100	360 mm
393 910 272	393 900 272	394 901 200	393 011 100	450 mm
393 920 272	393 900 272	394 901 200	393 021 100	450 mm
393 930 272	393 900 272	394 901 200	393 031 100	450 mm

## Monopolar cables

Art.-No.  
**395 502 500**

### Monopolar High frequency cable

3m length  
For SOPRO-COMEG monopolar electrodes and forceps  
To connect with electro surgery units model ERBE T-serie

Art.-No.  
**395 502 502**

### Monopolar High frequency cable

3m length  
For SOPRO-COMEG monopolar electrodes and forceps  
To connect with electro surgery units model ERBE ACC and ICC



Art.-No.  
**395 502 501**

### Monopolar High frequency cable

5m length  
For SOPRO-COMEG monopolar electrodes and forceps  
To connect with electro surgery units model ERBE T-serie

Art.-No.  
**395 502 503**

### Monopolar High frequency cable

3m length  
For SOPRO-COMEG monopolar electrodes and forceps  
To connect with electro surgery units model MARTIN and BERCHTOLD

Art.-No.  
**395 502 504**

### Monopolar High frequency cable

5m length  
For SOPRO-COMEG monopolar electrodes and forceps  
To connect with electro surgery units model MARTIN and BERCHTOLD



Art.-No.  
**395 502 505**

### Monopolar High frequency cable

3m length  
For SOPRO-COMEG monopolar electrodes and forceps  
To connect with electro surgery units model VALLEYLAB and CONMED

Art.-No.  
**395 502 506**

### Monopolar High frequency cable

5m length  
For SOPRO-COMEG monopolar electrodes and forceps  
To connect with electro surgery units model VALLEYLAB and CONMED



Art.-No.  
**395 502 507**

### Monopolar High frequency cable

3m length  
For SOPRO-COMEG monopolar electrodes and forceps  
To connect with electro surgery units model VARIOUS GENERATORS

Art.-No.  
**395 502 508**

### Monopolar High frequency cable

5m length  
For SOPRO-COMEG monopolar electrodes and forceps  
To connect with electro surgery units model VARIOUS GENERATORS





SOPRO  
COMEG



## **6 • INSTRUMENTS FOR MONOPOLAR AND BIPOLAR COAGULATION**

Monopolar electrodes . . . . .	p82
Monopolar cables . . . . .	p85
Bipolar electrodes . . . . .	p86
Bipolar coagulation forceps, scissors and dissectors . .	p88
Bipolar cables . . . . .	p91

## Monopolar Electrodes



Monopolar suction electrodes with trumpet valve

Art.-No.  
**392 999 500**

**Ø 5 mm Button electrode**  
330 mm length

Art.-No.  
**392 999 510**

**Ø 5 mm Button electrode**  
450 mm length



Art.-No.  
**392 999 502**

**Ø 5 mm Hook electrode**  
330 mm length

Art.-No.  
**392 999 512**

**Ø 5 mm Hook electrode**  
450 mm length



Art.-No.  
**392 999 503**

**Ø 5 mm, 90° Hook electrode**  
330 mm length

Art.-No.  
**392 999 513**

**Ø 5 mm, 90° Hook electrode**  
450 mm length



Art.-No.  
**392 999 504**

**Ø 5 mm Needle electrode**  
330 mm length

Art.-No.  
**392 999 514**

**Ø 5 mm Needle electrode**  
450 mm length



Art.-No.  
**392 999 505**

**Ø 5 mm Spatula electrode**  
330 mm length

Art.-No.  
**392 999 515**

**Ø 5 mm Spatula electrode**  
450 mm length



## Monopolar Electrodes



Monopolar suction electrodes

Art.-No.  
**392 999 600**

**Ø 5 mm Button electrode**  
330 mm length

Art.-No.  
**392 999 657**

**Ø 5 mm Button electrode**  
360 mm length

Art.-No.  
**392 999 610**

**Ø 5 mm Button electrode**  
450 mm length



Art.-No.  
**392 999 602**

**Ø 5 mm Hook electrode**  
330 mm length

Art.-No.  
**392 999 658**

**Ø 5 mm Hook electrode**  
360 mm length

Art.-No.  
**392 999 612**

**Ø 5 mm Hook electrode**  
450 mm length



Art.-No.  
**392 999 603**

**Ø 5 mm, 90° Hook electrode**  
330 mm length

Art.-No.  
**392 999 659**

**Ø 5 mm, 90° Hook electrode**  
360 mm length

Art.-No.  
**392 999 613**

**Ø 5 mm, 90° Hook electrode**  
450 mm length



Art.-No.  
**392 999 604**

**Ø 5 mm Needle electrode**  
330 mm length

Art.-No.  
**392 999 614**

**Ø 5 mm Needle electrode**  
450 mm length



Art.-No.  
**392 999 606**

**Ø 5 mm Spatula electrode**  
330 mm length

Art.-No.  
**392 999 616**

**Ø 5 mm Spatula electrode**  
450 mm length



Company

Optics

Trocars

Dissecting and  
grasping forceps

Scissors  
biopsy forceps

Instruments for  
coagulation

Divers  
accessories

Suture and  
ligature

Sterilization and  
maintenance

# 6 Instruments for monopolar and bipolar coagulation

Company

Optics

Trocars

Dissecting and grasping forceps

Scissors biopsy forceps

Instruments for coagulation

Divers accessories

Suture and ligature

Sterilization and maintenance

## Monopolar Electrodes



Monopolar electrodes

Art.-No.  
**392 999 900**

**Ø 5 mm Button electrode**  
330 mm length

Art.-No.  
**392 999 910**

**Ø 5 mm Button electrode**  
450 mm length



Art.-No.  
**392 999 902**

**Ø 5 mm Hook electrode**  
330 mm length

Art.-No.  
**392 999 912**

**Ø 5 mm Hook electrode**  
450 mm length



Art.-No.  
**392 999 903**

**Ø 5 mm, 90° Hook electrode**  
330 mm length

Art.-No.  
**392 999 913**

**Ø 5 mm, 90° Hook electrode**  
450 mm length



Art.-No.  
**392 999 904**

**Ø 5 mm Needle electrode**  
330 mm length

Art.-No.  
**392 999 914**

**Ø 5 mm Needle electrode**  
450 mm length



Art.-No.  
**392 999 905**

**Ø 5 mm Spatula electrode**  
330 mm length

Art.-No.  
**392 999 915**

**Ø 5 mm Spatula electrode**  
450 mm length





## Monopolar cables

Art.-No.  
**395 502 500**

### Monopolar High frequency cable

3m length  
For SOPRO-COMEG monopolar electrodes and forceps  
To connect with electro surgery units model ERBE T-serie

Art.-No.  
**395 502 502**

### Monopolar High frequency cable

3m length  
For SOPRO-COMEG monopolar electrodes and forceps  
To connect with electro surgery units model ERBE ACC and ICC



Art.-No.  
**395 502 501**

### Monopolar High frequency cable

5m length  
For SOPRO-COMEG monopolar electrodes and forceps  
To connect with electro surgery units model ERBE T-serie

Art.-No.  
**395 502 503**

### Monopolar High frequency cable

3m length  
For SOPRO-COMEG monopolar electrodes and forceps  
To connect with electro surgery units model MARTIN and BERCHTOLD

Art.-No.  
**395 502 504**

### Monopolar High frequency cable

5m length  
For SOPRO-COMEG monopolar electrodes and forceps  
To connect with electro surgery units model MARTIN and BERCHTOLD



Art.-No.  
**395 502 505**

### Monopolar High frequency cable

3m length  
For SOPRO-COMEG monopolar electrodes and forceps  
To connect with electro surgery units model VALLEYLAB and CONMED

Art.-No.  
**395 502 506**

### Monopolar High frequency cable

5m length  
For SOPRO-COMEG monopolar electrodes and forceps  
To connect with electro surgery units model VALLEYLAB and CONMED



Art.-No.  
**395 502 507**

### Monopolar High frequency cable

3m length  
For SOPRO-COMEG monopolar electrodes and forceps  
To connect with electro surgery units model VARIOUS GENERATORS

Art.-No.  
**395 502 508**

### Monopolar High frequency cable

5m length  
For SOPRO-COMEG monopolar electrodes and forceps  
To connect with electro surgery units model VARIOUS GENERATORS



# 6 Instruments for monopolar and bipolar coagulation

Company

Optics

Trocars

Dissecting and grasping forceps

Scissors biopsy forceps

Instruments for coagulation

Divers accessories

Suture and ligature

Sterilization and maintenance

## Bipolar electrodes

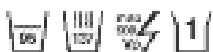

Coagulation instruments with a diameter of only 3 mm enable precise working during laparoscopy with only minimum incision. The connection is ensured by a bipolar standard cable with flat plug.

Art.-No.  
**392 993 012**

**Ø 3 mm Bipolar L-hook**  
340 mm length

Art.-No.  
**392 993 125**

**Ø 3 mm Bipolar L-hook**  
360 mm length



Art.-No.  
**392 993 013**

**Ø 3 mm Bipolar V-hook**  
340 mm length

Art.-No.  
**392 993 126**

**Ø 3 mm Bipolar V-hook**  
360 mm length



Art.-No.  
**392 993 014**

**Ø 3 mm Bipolar needle**  
340 mm length

Art.-No.  
**392 993 127**

**Ø 3 mm Bipolar needle**  
360 mm length



## Bipolar electrodes

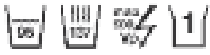

The bipolar coagulation electrodes enable the dissection and coagulation of tissue. The product range comprises instruments for both extensive and pinpoint coagulation. Advanced bipolar technology and the optimum arrangement of the poles enable safe working with precisely defined coagulation areas. The isolation coating between the electrode ensures a constant distance and, therefore, provides uniform coagulation results.

Art.-No.

**392 993 008**

**Ø 5 mm J-hook**

340 mm length



Art.-No.

**392 993 009**

**Ø 5 mm L-hook**

340 mm length



Art.-No.

**392 993 010**

**Ø 5 mm Spatula**

340 mm length



Art.-No.

**392 993 011**

**Ø 5 mm Dôme**

340 mm length



# 6 Instruments for monopolar and bipolar coagulation

Company

Optics

Trocars

Dissecting and grasping forceps

Scissors biopsy forceps

Instruments for coagulation

Divers accessories

Suture and ligature

Sterilization and maintenance

## Bipolar coagulation forceps, scissors and dissectors



The bipolar coagulation forceps are instruments used for grasping, cutting and bipolar coagulation in laparoscopic surgery. Their mechanism enables active and precise opening and closing of the jaws as well as applying very high pressure when grasping and cutting while precisely coagulating the tissue. Electrode inserts for different applications can be exchanged within a few seconds.

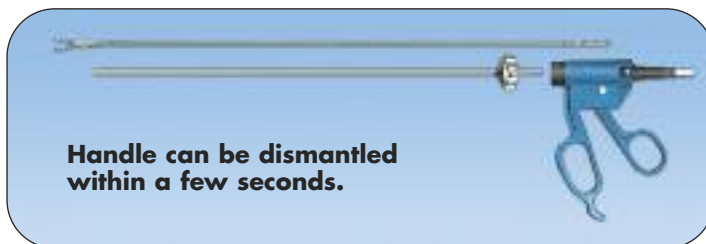

Handle can be dismantled within a few seconds.

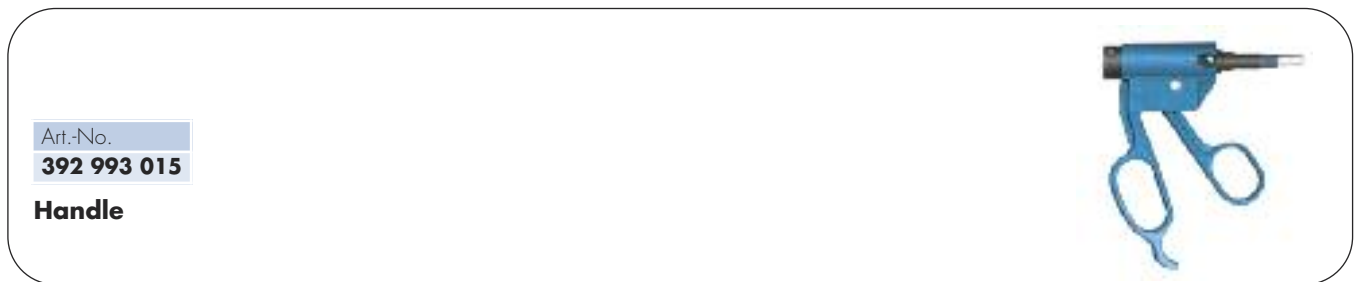

Art.-No.  
**392 993 015**

**Handle**



Art.-No.  
**392 993 016**

**Ø 5 mm Outer tube**  
340 mm length

## Bipolar coagulation forceps, scissors and dissectors

### Ø 5 mm Grasping forceps, fenestrated

Complete instrument	Insert	Tube	Handle	Length
392 993 017	392 993 117	392 993 016	392 993 015	340 mm



### Ø 5 mm Forceps with curved jaws, slim

Complete instrument	Insert	Tube	Handle	Length
392 993 018	392 993 118	392 993 016	392 993 015	340 mm



### Ø 5 mm Delta grasping forceps, fenestrated

Complete instrument	Insert	Tube	Handle	Length
392 993 019	392 993 119	392 993 016	392 993 015	340 mm



### Ø 5 mm Grasping forceps, fenestrated and curved

Complete instrument	Insert	Tube	Handle	Length
392 993 021	392 993 121	392 993 016	392 993 015	340 mm



### Ø 5 mm Claw forceps

Complete instrument	Insert	Tube	Handle	Length
392 993 024	392 993 124	392 993 016	392 993 015	340 mm



### Ø 5 mm Curved scissors, Metzenbaum type

Complete instrument	Insert	Tube	Handle	Length
392 993 022	392 993 122	392 993 016	392 993 015	340 mm



### Ø 5 mm Maryland dissector, curved

Complete instrument	Insert	Tube	Handle	Length
392 993 023	392 993 123	392 993 016	392 993 015	340 mm



Company

Optics

Trocars

Dissecting and grasping forceps

Scissors biopsy forceps

Instruments for coagulation

Divers accessories

Suture and ligature

Sterilization and maintenance

## Bipolar coagulation forceps, scissors and dissectors



Art.-No.  
**392 993 001**

### Ø 5 mm Bipolar forceps with fenestrated jaws

Complete instrument  
330 mm length



Art.-No.  
**392 993 002**

### Ø 5 mm Bipolar forceps with short jaws

Complete instrument  
330 mm length



Art.-No.  
**392 993 003**

### Ø 5 mm Bipolar forceps with long jaws

Complete instrument  
330 mm length



## Bipolar cables

Art.-No.  
**390 803 000**

### Bipolar High frequency cable

3m length  
For SOPRO-COMEG bipolar electrodes and forceps to connect with electro surgery units model SELECT and ERBE

Art.-No.  
**390 805 000**

### Bipolar High frequency cable

5m length  
For SOPRO-COMEG bipolar electrodes and forceps to connect with electro surgery units model SELECT and ERBE



Art.-No.  
**390 813 000**

### Bipolar High frequency cable

3m length  
For SOPRO-COMEG bipolar electrodes and forceps to connect with electro surgery units model MARTIN

Art.-No.  
**390 815 000**

### Bipolar High frequency cable

5m length  
For SOPRO-COMEG bipolar electrodes and forceps to connect with electro surgery units model MARTIN



Art.-No.  
**390 863 000**

### Bipolar High frequency cable

3m length  
For SOPRO-COMEG bipolar electrodes and forceps to connect with electro surgery units model AESCULAP

Art.-No.  
**390 865 000**

### Bipolar High frequency cable

5m length  
For SOPRO-COMEG bipolar electrodes and forceps to connect with electro surgery units model AESCULAP



Art.-No.  
**390 843 000**

### Bipolar High frequency cable

3m length  
For SOPRO-COMEG bipolar electrodes and forceps to connect with electro surgery units model AMERICAN UNITS

Art.-No.  
**390 845 000**

### Bipolar High frequency cable

5m length  
For SOPRO-COMEG bipolar electrodes and forceps to connect with electro surgery units model AMERICAN UNITS



The logo features two curved, swoosh-like shapes. The top swoosh is light green and curves from the right side towards the center. The bottom swoosh is light blue and curves from the left side towards the center. The text 'SOPRO' and 'COMEG' is centered between these two swooshes.

**SOPRO**  
**COMEG**



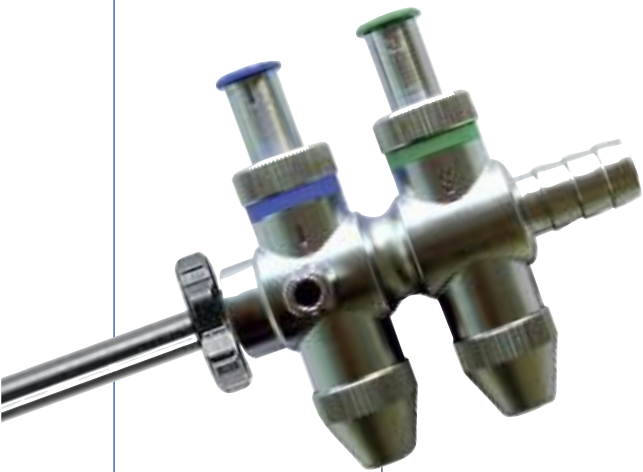

## **7 • ACCESSORIES**

Palpation probes . . . . .	p94
Injection and punction needles . . . . .	p94
Retractors . . . . .	p94
Extractor . . . . .	p94
Cholangiography . . . . .	p95
Handles and modular instruments for irrigation and aspiration . . . . .	p95

## Palpation probes



Art.-No.  
**392 999 300**

**Ø 5 mm Palpation probe, graduated**  
330 mm length

Art.-No.  
**392 999 299**

**Ø 5 mm Palpation probe, graduated**  
450 mm length

## Injection and punction needles



**Ø 5 mm injection punction needles**

Complete instrument	Length	Outer Ø	Needle Ø
392 999 301	330 mm	Ø 5 mm	Ø 1,4 mm
392 999 302	450 mm	Ø 5 mm	Ø 1,4 mm

## Retractors



Art.-No.  
**392 995 003**

**Ø 5 mm retractor**  
3 fingers (68 mm length)  
Total length 330 mm



Art.-No.  
**392 995 001**

**Ø 10 mm Liver elevator with double function**  
330 mm length - Spread and Lift

## Extractor



Art.-No.  
**392 996 002**

**Abdominal specula**

**Cholangiography**



Art.-No.  
**393 999 700**

**Ø 5 mm Cholangiogram clamp**  
330 mm length

**Handles and modular instruments for irrigation and aspiration**



Art.-No.  
**392 999 220**

**Ø 5 mm Suction-Irrigation**  
Cannula with Sliding Valve and Roundhole Sucker with handle and 4 holes  
Working length 330 mm



Art.-No.  
**392 999 201**

**Ø 5 mm Suction-Irrigation**  
Cannula with Tube connection and Roundhole Sucker with 4 holes  
Working length 330 mm



Art.-No.  
**392 999 202**

**Set of suction and irrigation tubes with interchangeable tubes Ø 5 mm and Ø 10 mm**  
With Luer-Lock  
Working length 330 mm

Company

Optics

Trocars

Dissecting and  
grasping forceps

Scissors  
biopsy forceps

Instruments for  
coagulation

Divers  
accessories

Suture and  
ligature

Sterilization and  
maintenance

## Handles and modular instruments for irrigation and aspiration

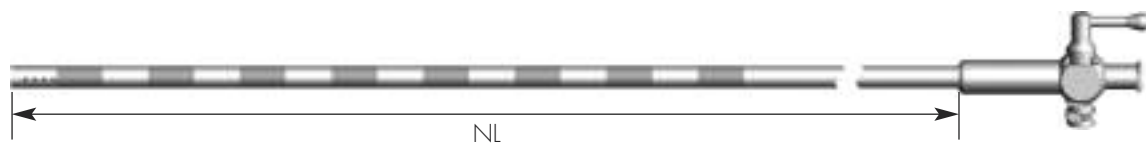

Art.-No.  
**392 999 213**

### Ø 5 mm Suction-Irrigation

Cannula  
With Luer-Lock connection and Stop Cock, Suction tube graduated, 16 drillings  
Working length 330 mm

Art.-No.  
**392 999 212**

### Ø 5 mm Suction-Irrigation

Cannula  
With Luer-Lock connection and Stop Cock, Suction tube graduated, 16 drillings  
Working length 450 mm

Art.-No.  
**392 999 250**

### Suction irrigation Pistol Handle

With sliding valve for exchangeable shafts with thread M8x1  
2 combined Luer-Lock/Tube Connectors



Art.-No.  
**392 999 270**

### Ø 3 mm Exchangeable Suction irrigation shaft

With thread M8x1 and 4 sidewise drillings  
Working length 340 mm

Art.-No.  
**392 999 260**

### Ø 5 mm Exchangeable Suction irrigation shaft

With thread M8x1 and 4 sidewise drillings  
Working length 340 mm

Art.-No.  
**392 999 280**

### Ø 10 mm Exchangeable Suction irrigation shaft

With thread M8x1 and 4 sidewise drillings  
Working length 340 mm



SOPRO  
COMEG



SOPRO  
COMEG

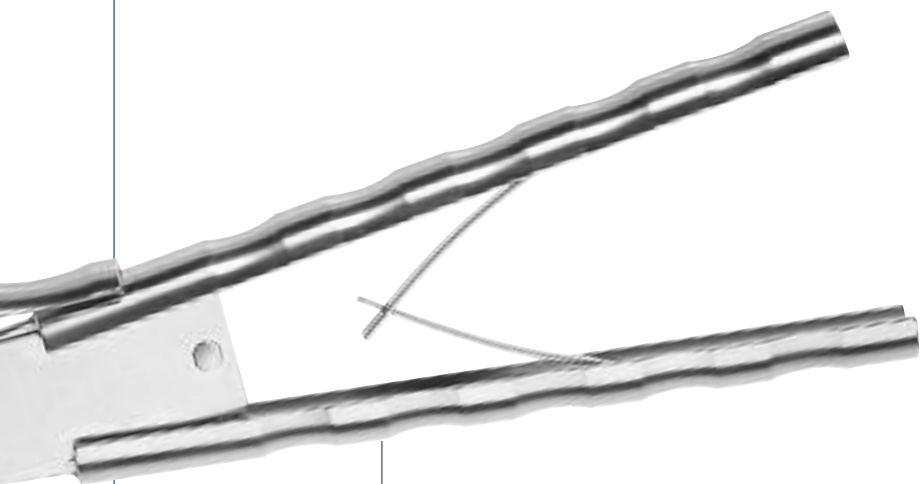

## **8 • SUTURE AND LIGATURE**

Needle holder . . . . .	p100
Knot pushers . . . . .	p102
Facial closure . . . . .	p102
Clip applying forceps . . . . .	p103

**Needle holder**

Art.-No.  
**393 041 100**

**Axial ring handle, with ratchet**



Art.-No.  
**393 051 100**

**Axial handle, with spreading spring and ratchet**

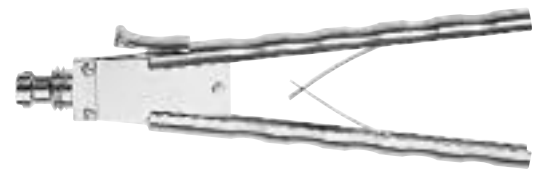

Art.-No.  
**393 061 100**

**Axial handle, with spreading spring**

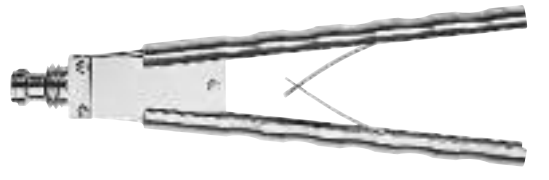

**Ø 5mm Needle holder straight, with inserted tungsten carbide, crosswise teeth**  
Single action jaws



Complete instrument	Insert	Tube	Handle	Length
393 540 046	393 500 046	393 501 100	393 041 100	330 mm
393 550 046	393 500 046	393 501 100	393 051 100	330 mm
393 560 046	393 500 046	393 501 100	393 061 100	330 mm
393 540 146	393 500 146	393 501 300	393 041 100	360 mm
393 550 146	393 500 146	393 501 300	393 051 100	360 mm
393 560 146	393 500 146	393 501 300	393 061 100	360 mm
394 540 046	394 500 046	394 501 200	393 041 100	450 mm
394 550 046	394 500 046	394 501 200	393 051 100	450 mm
394 560 046	394 500 046	394 501 200	393 061 100	450 mm



## Needle holder

## Ø 5mm Needle holder right curved, with inserted tungsten carbide, crosswise teeth

Single action jaws

Complete instrument	Insert	Tube	Handle	Length
393 540 047	393 500 047	393 501 100	393 041 100	330 mm
393 550 047	393 500 047	393 501 100	393 051 100	330 mm
393 560 047	393 500 047	393 501 100	393 061 100	330 mm
393 540 147	393 500 147	393 501 300	393 041 100	360 mm
393 550 147	393 500 147	393 501 300	393 051 100	360 mm
393 560 147	393 500 147	393 501 300	393 061 100	360 mm
394 540 047	394 500 047	394 501 200	393 041 100	450 mm
394 550 047	394 500 047	394 501 200	393 051 100	450 mm
394 560 047	394 500 047	394 501 200	393 061 100	450 mm



## Ø 5mm Needle holder left curved, with inserted tungsten carbide, crosswise teeth

Single action jaws

Complete instrument	Insert	Tube	Handle	Length
393 540 048	393 500 048	393 501 100	393 041 100	330 mm
393 550 048	393 500 048	393 501 100	393 051 100	330 mm
393 560 048	393 500 048	393 501 100	393 061 100	330 mm
393 540 148	393 500 148	393 501 300	393 041 100	360 mm
393 550 148	393 500 148	393 501 300	393 051 100	360 mm
393 560 148	393 500 148	393 501 300	393 061 100	360 mm
394 540 048	394 500 048	394 501 200	393 041 100	450 mm
394 550 048	394 500 048	394 501 200	393 051 100	450 mm
394 560 048	394 500 048	394 501 200	393 061 100	450 mm



## Ø 5mm Needle holder/positioner, convex/concave shaped jaws, with fixation teeth, with wolfram-carbide-coated tips

Single action jaws

Complete instrument	Insert	Tube	Handle	Length
393 540 049	393 500 049	393 501 100	393 041 100	330 mm
393 550 049	393 500 049	393 501 100	393 051 100	330 mm
393 560 049	393 500 049	393 501 100	393 061 100	330 mm
393 540 149	393 500 149	393 501 300	393 041 100	360 mm
393 550 149	393 500 149	393 501 300	393 051 100	360 mm
393 560 149	393 500 149	393 501 300	393 061 100	360 mm
394 540 049	394 500 049	394 501 200	393 041 100	450 mm
394 550 049	394 500 049	394 501 200	393 051 100	450 mm
394 560 049	394 500 049	394 501 200	393 061 100	450 mm



Company  
Optics  
Trocars  
Dissecting and grasping forceps  
Scissors biopsy forceps  
Instruments for coagulation  
Divers accessories  
Suture and ligature  
Sterilization and maintenance

**Knot pushers**

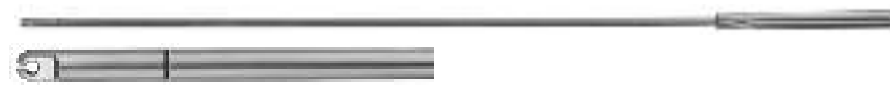

Art.-No. **392 999 400**  
**Ø 4 mm Knot pusher with open eye**  
 330 mm length

Art.-No. **392 999 450**  
**Ø 4 mm Knot pusher with open eye**  
 450 mm length



Art.-No. **392 999 401**  
**Ø 4.5 mm Knot guide with slot**  
 330 mm length



Art.-No. **392 999 403**  
**Ø 4 mm Knot pusher with closed eye**  
 330 mm length

Art.-No. **392 999 453**  
**Ø 4 mm Knot pusher with closed eye**  
 450 mm length

**Facial closure**



Art.-No. **392 999 402**  
**Ø 2.3 mm Facial closure**  
 140 mm length

## Clip applying forceps

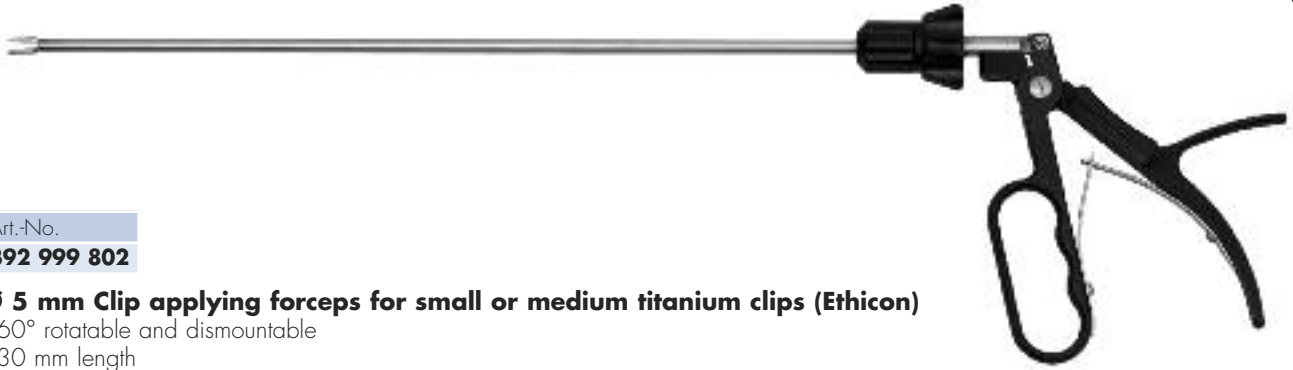

Art.-No.  
**392 999 802**

**Ø 5 mm Clip applying forceps for small or medium titanium clips (Ethicon)**  
360° rotatable and dismantable  
330 mm length

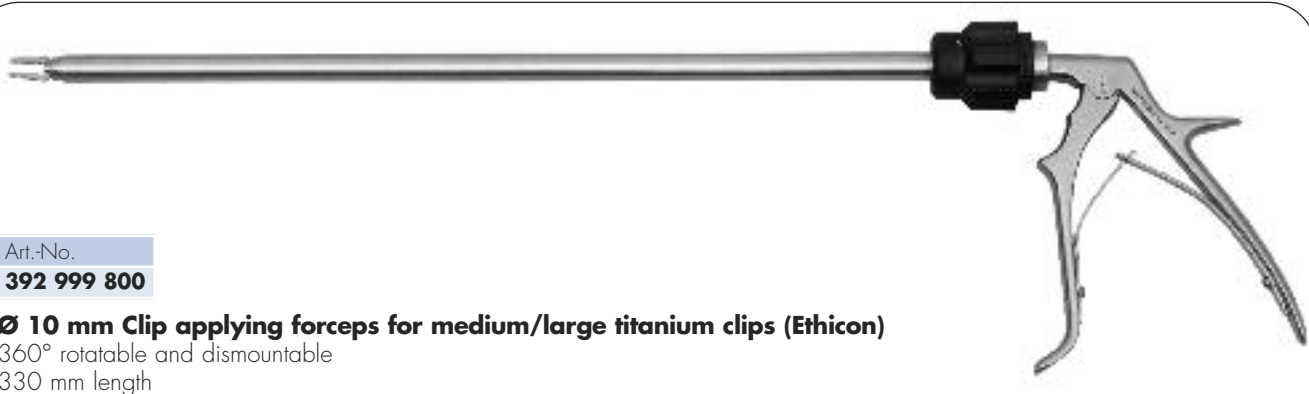

Art.-No.  
**392 999 800**

**Ø 10 mm Clip applying forceps for medium/large titanium clips (Ethicon)**  
360° rotatable and dismantable  
330 mm length

Art.-No.  
**392 999 803**

**Ø 10 mm Clip applying forceps for large titanium clips (Ethicon)**  
360° rotatable and dismantable  
330 mm length



Art.-No.  
**392 999 801**

**Titanium clips (Ethicon)**  
Medium large 18 x 6 pieces

Art.-No.  
**392 999 804**

**Titanium clips (Ethicon)**  
Small 18 x 6 pieces

The logo features two curved, swoosh-like shapes. The top swoosh is light green and curves from the right side towards the center. The bottom swoosh is light blue and curves from the left side towards the center. The text 'SOPRO' and 'COMEG' is centered between these two swooshes.

**SOPRO**  
**COMEG**

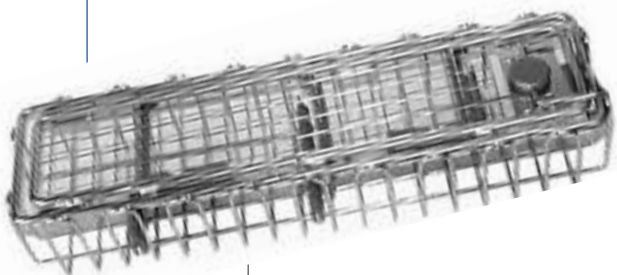

## **9 • MAINTENANCE, CLEANING AND STERILIZATION**

General information . . . . .	p106
Handling instructions for telescopes . . . . .	p107
Sterilization baskets . . . . .	p108

## General information

All our products are delivered with a IFU (Instruction for Use) where you will find all proper advices as far as maintenance, cleaning and sterilization are concerned.

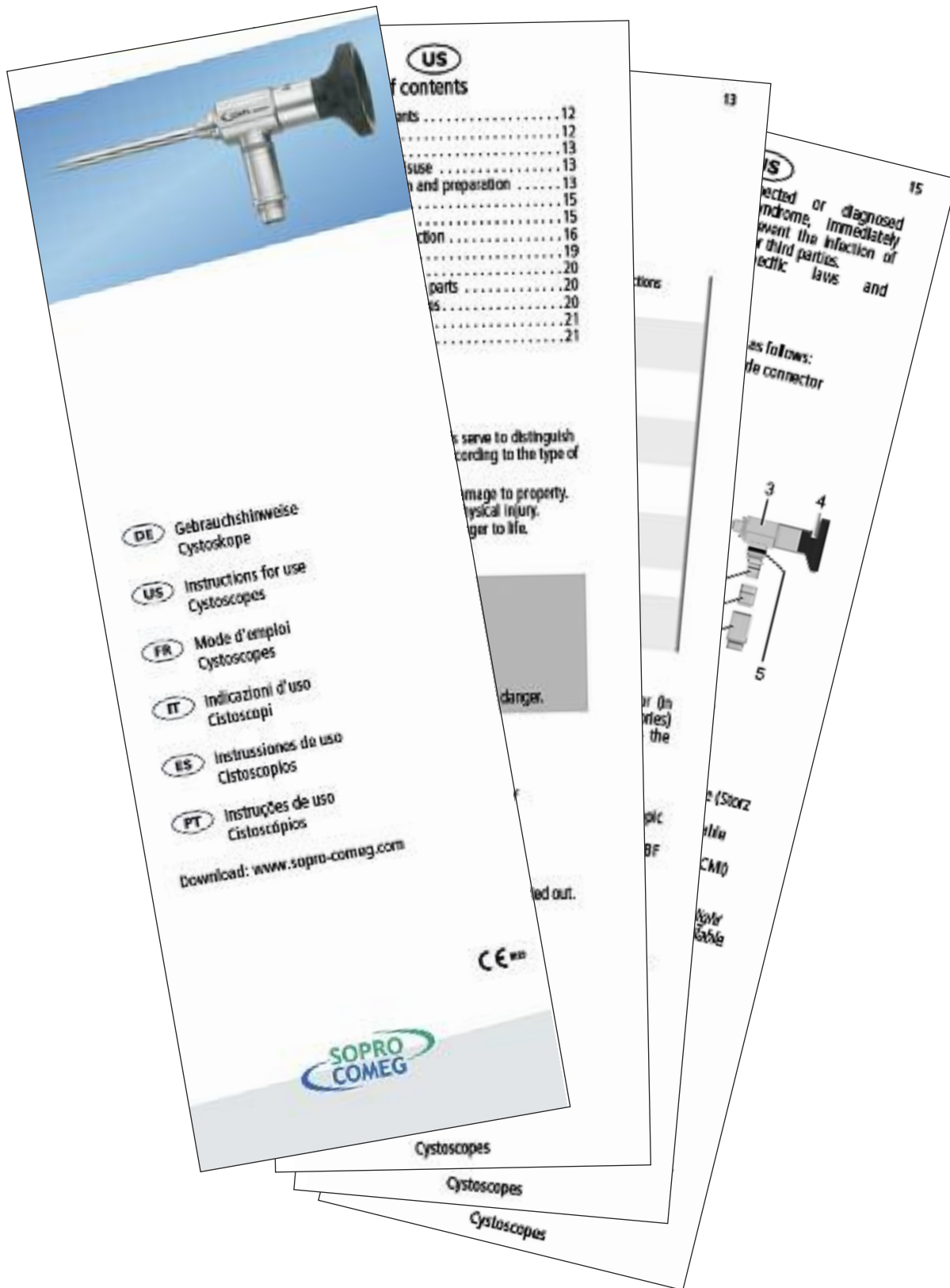

Cystoscopes

Cystoscopes

Cystoscopes

## Handling instructions for telescopes

The telescopes are intended to be used according to the general instructions and only by instructed or trained medical personnel.

Service and maintenance may just be performed by authorized service personnel.

Prior and after each use on the telescopes a visual and functional inspection for completeness, optical quality, rough surfaces, sharp edges and prominent parts has to be performed. Immediately after each use the telescopes have to be cleaned and disinfected.

Special care has to be taken to scopes with working channel. It must be ensured that the solution for disinfection reaches all areas within the narrow working channel.

For the adjacent sterilization process the telescopes must be free of contaminations and residues of the agent.

In order to be compatible to other products and to allow combinations please make sure that the intended use and technical parameters (working length, diameter, connection type, etc.) match and do not adversely affect the performance and the safety requirements.

Please refer to applicable instruction manuals.

As with any optical device, SOPRO-COMEG telescopes are fragile and should be handled with care. In order to avoid damage or loss of quality the following instructions concerning handling, storing and transportation have to be followed:

- Always hold the endoscope by its eyepiece or body part!
- If possible, store the endoscopes individually!
- Avoid contact between the glass parts and other instruments or surfaces!
- The telescopes may under no circumstances be exposed to Gamma radiation! The image quality can be adversely affected!
- Do not drop the endoscope and do not bend the tube, or otherwise add mechanical stress!

### Conditions of use, storage and transport:

Use: +10° C to +134° C, 30% to 100 % rel. humidity, pressure 700 hP to 2000 hP  
 Storage/ Transport: -20° C to +60° C, 10% to 90 % rel. humidity, pressure 700 hP to 1060 hP

### Safety information:

Check and sterilize instrument prior to any use. In case of any doubt return instrument to manufacturer for investigation and safety check. Disposal of product please refer to the specific regulations of your country.

Handling: In case you do not have the current version of the Handling and Instruction Guide we would be pleased to send a copy upon request.

Combinations: A requirement for common use with other products is the correspondence in intended use and the technical specifications (working length, diameter, etc.). Further information you will find in our product catalogues.

Warranty: For the warranty time please look at our general trade conditions. Excluded from warranty are misuse, incorrectly cleaning, maintenance and repair, normal wear and tear and defects, known at the time of cession.

Prior to each use and/or returning to the manufacturer the products have to be cleaned and sterilized according to this maintenance instructions.

## Sterilization baskets

Include a cover and a silicone endoscope holder for easier handling during treatment (cleaning, sterilization, etc.) maximum protection against damages suitable for steam, gas and plasma sterilization

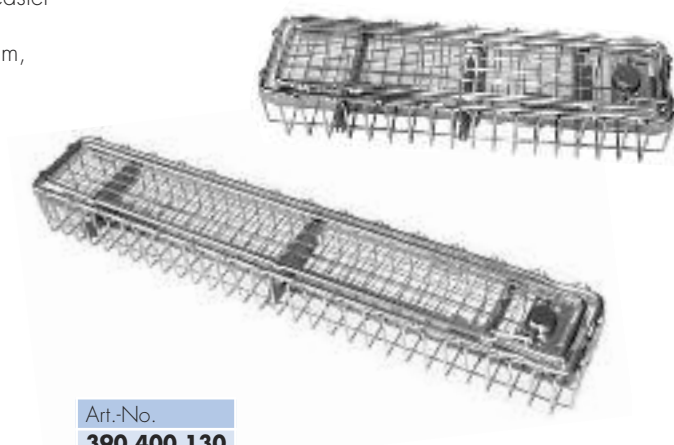

Art.-No.

**390 400 100****Sterilization basket**

With silicone holder  
Size 290 x 80 x 52mm

Art.-No.

**390 400 110****Sterilization basket**

With silicone holder  
Size 460 x 80 x 52mm

Art.-No.

**390 400 130****Sterilization basket**

With silicone holder  
Size 458 x 166 x 82mm

Art.-No.

**390 400 150****Sterilization basket**

With silicone holder  
Size 640 x 150 x 77mm

Art.-No.

**191 402 061****Plastic sterilization tube for endoscope**

For steam sterilization  
Box of 10 units





## Sterilization baskets

Art.-No.  
**390 400 160**

### Plastic sterilization box

For steam sterilization  
Delivered with a silicone mat  
Size 530 x 255 x 67mm



Art.-No.  
**390 400 170**

### Plastic sterilization box

For steam sterilization  
Delivered with a silicone mat and an internal tray  
Size 530 x 255 x 110mm



Art.-No.  
**390 400 180**

### Plastic sterilization box

For steam sterilization  
Delivered with a silicone mat and two internal trays  
Size 530 x 255 x 140mm



## Plastic sterilization boxes

Art.-No.  
**390 400 190**

### Plastic sterilization box

for two telescopes  
Size 394 x 70 x 35mm

Art.-No.  
**390 400 200**

### Plastic sterilization box

for two telescopes  
Size 457 x 70 x 35mm







.....

.....

.....

.....

.....

.....

.....

.....

.....

.....

.....

.....

.....

.....

.....

.....

.....

.....

.....

.....

.....

.....

.....

.....



SOPRO  
COMEG

## SOPRO-COMEG worldwide



### SOPRO-COMEG COMMITMENTS

#### Customer proximity

Direct and quick communication with our local sales force.

National placed inventory to ensure quick delivery time.

#### Service

Worldwide service centres to ease and fasten the support of our complete product line.

#### R&D

A network of 50 engineers to foster on products innovations and new technologies.



French production plant:  
ZAC Athélia IV  
Avenue des Genévriers  
13705 La Ciotat cedex - France  
Tél. +33 (0) 442 98 01 01  
Fax +33 (0) 442 71 76 90  
info@sopro-comeg.com

[www.sopro-comeg.com](http://www.sopro-comeg.com)



German production plant:  
Dornierstr. 55  
D-78532 Tuttlingen - Germany  
Tel +49 (0) 7461-9344-0  
Fax +49 (0) 7461-9344-20  
info@sopro-comeg.com

[www.sopro-comeg.com](http://www.sopro-comeg.com)

