



Plastische Chirurgie
Plastic Surgery
Cirugía Plástica
Chirurgia Plastica



Reda Instrumente GmbH

Gänsäcker 34 - P.O. Box 131
D-78532 Tuttlingen

Telefon +49/7462/9445-0

Telefax +49/7462/9445-20

e-mail: info@Reda-Instrumente.de

<http://www.Reda-Instrumente.de>

Ausgabe Nr. 2

Datum: 09/2011

Charrière (Ch) French (F)	Durchmesser in mm	Inches
1	0,33	0,013
2	0,67	0,025
3	1,00	0,039
4	1,33	0,051
5	1,67	0,065
6	2,00	0,0787
7	2,33	0,092
8	2,67	0,105
9	3,00	0,1181
10	3,33	0,131
11	3,67	0,144
12	4,00	0,1575
13	4,33	0,170
14	4,67	0,184
15	5,00	0,1968
16	5,33	0,210
17	5,67	0,223
18	6,00	0,2362
19	6,33	0,249
20	6,67	0,263
21	7,00	0,2756
22	7,33	0,288
23	7,67	0,302
24	8,00	0,3150
25	8,33	0,328
26	8,67	0,341
27	9,00	0,3543
28	9,33	0,367
29	9,67	0,380
30	10,00	0,3973
31	10,33	0,407
32	10,67	0,420
34	11,33	0,446
36	12,00	0,4724
38	12,67	0,494
40	13,33	0,5199
45	15,00	0,5905

Gauge (G)	Durchmesser in mm	Inches
35	0,13	0,005
34	0,18	0,007
33	0,20	0,008
32	0,23	0,009
31	0,25	0,010
30	0,30	0,012
29	0,33	0,013
28	0,36	0,014
27	0,41	0,016
26	0,46	0,018
25	0,51	0,020
	0,53	0,021
24	0,56	0,022
23	0,64	0,025
22	0,71	0,028
21	0,81	0,032
20	0,89	0,035
	0,97	0,038
19	1,07	0,042
18	1,27	0,050
17	1,50	0,059
16	1,65	0,065
15	1,83	0,072
14	2,11	0,083
13	2,41	0,095
12	2,77	0,109
11	3,05	0,120
10	3,40	0,134
9	3,76	0,148
8	4,19	0,165
7	4,57	0,180
6	5,16	0,203

1 OZ	0,028 ml
5 OZ	0,140 ml
16 OZ	0,450 ml

35 OZ	1,0 l
128 OZ	3,7 l

GARANTIE / WARRANTY / GARANTIA / GARANZIA

GARANTIE

Wir gewähren auf alle **Reda**-Instrumente 5 Jahre Garantie. Voraussetzung ist der sach- und fachgerechte Einsatz der Instrumente. Von der Garantie sind Verschleißerscheinungen ausgeschlossen.

WARRANTY

Our **Reda** products are free from manufacturing defects in material and workmanship. We therefore give on all instruments a guarantee of five years provided that the instruments are maintained and cleaned properly and used normally for their intended purpose.

GARANTIA

Estamos convencidos de nuestra calidad y concedemos a todos los instrumentos de **Reda** 5 años de garantía contra cualquier defecto de fabricación, siempre y cuando se usen adecuadamente. De la garantía excluimos la manifestación de desgaste.

GARANZIA

Siamo convinti della nostra qualità e concediamo cinque anni di garanzia sulla funzione dei tutti gli strumenti **Reda** sotto la presupposizione che l'utilizzo è da esperto. Escluso della garanzia sono tracce di consumo.

Arbeitsanweisung Aufbereitung (Reinigung) und Sterilisation von resterilisierbaren chirurgischen Instrumenten

DIN EN ISO 17664:2004 (D)

Hersteller:
REDA Instrumente GmbH, Gänsäcker 34
78532 Tuttlingen

Alle von Reda gelieferten wieder verwendbaren Instrumente wurden ausschließlich für den chirurgischen Gebrauch konstruiert und dürfen zu keinen anderen Zwecken benutzt werden. Unsachgemäße Handhabung und sorglose Pflege sowie zweckentfremdeter Gebrauch können zu vorzeitigem Verschleiß der Instrumente führen. Die Produkte sind bei der Auslieferung nicht sterilisiert.

Reinigungsvorbereitung

Fabrikneue Instrumente müssen vor der ersten Anwendung den gesamten Aufbereitungsprozess durchlaufen. Instrumente unmittelbar nach Anlieferung aus den Folienverpackungen entnehmen und in trockenen Räumen bei gleichbleibender Raumtemperatur luftoffen lagern, um Kondensationsbildung zu vermeiden.

Die Instrumente keinen Sonnenlichteinstrahlungen oder Dämpfen durch Chemikalien (Säuren oder scharfe Reinigern) aussetzen.

Vor der ersten Sterilisation alle Schutzkappen und Folien vollständig entfernen und anschließend reinigen.

Gebrauchte Instrumente unmittelbar nach Beendigung des Eingriffs von Blut, Gewebe und Arzneimittel reinigen. Instrumente in eine freigegebene Lösung eines kombinierten Reinigungs- und Desinfektionsmittels, das keine proteinfixierende Wirkung besitzt, einlegen.

Dosierung des Herstellers beachten. Nicht in NaCl Lösung einlegen, ansonsten Gefahr für Loch- bzw. Spannungsriss-Korrosion

Überfüllung von Instrumentensieben und Wasch-Trays vermeiden.

Gelenkinstrumente vor dem Aufbereiten öffnen. Zerlegbare Instrumente gemäß Bedienungsanleitung (Piktogramm) zur Reinigung zerlegen. Reinigungsgerechtes Zubehör verwenden. Für die manuelle Reinigung nie Metallbürsten oder Metallschwämme verwenden.

Spülmaschinen und Ultraschallanlagen nicht überladen. Spül- oder Schallschatten vermeiden. Dosierung, Einwirkzeit und Einwirktemperatur bei der Desinfektion und Reinigung unbedingt einhalten. Nach der Reinigung sorgfältig spülen. Möglichst vollentsalztes (demineralisiertes) Wasser verwenden.

Nach dem Spülen ausreichend trocknen. Abgenutzte, korrodierte, deformierte, poröse oder anderweitig beschädigte Instrumente austrieren.

Aus hygienischen Gründen müssen Instrumente, die zur Reparatur eingesandt werden komplett aufbereitet werden.

Gelenkinstrumente nach jeder Aufbereitung mit einem Pflegemittel auf Basis von Paraffinöl behandeln (gilt nicht für flexible Endoskope und Zubehör).

Funktionsprüfung in zusammengebautem Zustand durchführen.

Instrumente mit Rastensperre vor der Sterilisation nur im ersten Zahn schließen.

Als Sterilisationsverfahren empfehlen wir die Dampfsterilisation (üblicherweise mit Sattedampf bei 134° C)

Sterilisation ist kein Ersatz für Sauberkeit!

Die Broschüre "Instrumenten-Aufbereitung richtig gemacht" des Arbeitskreis Instrumenten-Aufbereitung dient als Anhalt.

Reda Instrumente GmbH
78532 Tuttlingen

IMPORTANT INFORMATION CONCERNING PREPARING AND STERILIZING SURGICAL INSTRUMENTS

Dear Sirs,
please read the following instructions very carefully before using the instruments.

1. INITIAL USE

All instruments which are being used for the first time must be thoroughly cleaned, rinsed and then sterilized before using.

2. TREATING INSTRUMENTS AFTER USAGE

- a.) The instruments might be immediately thoroughly cleaned and disinfected. Please follow the manufacturer's instructions when using cleaning agents and disinfectants.
- b.) Instruments which may be dismantled must be cleaned and disinfected after being taken apart.
- c.) Cleaning may be carried out either manually or with a machine. Care should be taken that only cleaning agents and disinfectants are used, which are changed daily.
- d.) Following chemical disinfection and manual cleaning, all instruments must always be thoroughly rinsed under running water.
- e.) The temperature of water used in a machine for cleaning should not exceed 45°C.
- f.) Whether cleaning is carried out manually or by machine, we especially ask you to ensure that the correct dosage for cleaning solutions or the correct combination of disinfectant and cleaning solution, is employed. Similar importance should be applied to the length of time the agents require to perform properly and to the temperature set.
- g.) Hinged instruments should be opened before cleaning.
- h.) Please ensure that the perforated instrument trays, when loaded, do not exceed 10 kg in weight.
- i.) Please take care that when instruments are being cleaned they are arranged proper in a manne that fluids can circulate freely.
- j.) Deposits remaining after the cleaning process must be completely removed in the first rinse which now follows. The optimum temperature for final rinsing has proved to be between 70° and 90° C. Please use only purified water in this final cleaning stage.
- k.) The instruments must be carefully dried after cleaning and rinsing is completed.
- l.) Moving parts and the cutting edges of shears and scissors must be treated with preservatives which are both suitable and physiologically safe.

3. TESTING FOR CORRECT FUNCTIONING

- a.) Instruments must be carefully and thoroughly checked before every occasion that they are used.

- b.) After each time they are cleaned, the instruments must be macroscopically clean, i.e., visibly free from proteinbased residues and other soiling.
- c.) Care should be taken so that cracks, breakages and corrosion are noticed.
- d.) Instruments with flecks should be separated and taken out for special treatment.
- e.) All moving parts as well as working tips and blades should be checked with special care.
- f.) Checking should be carried out according to the extent to which the instruments will be used.
- g.) Instruments which are in any way defective or damaged should be immediately sorted out from the others.

4. STERILIZATION

- a.) All stainless steel surgical instruments supplied by us may be sterilized in an autoclave.
- b.) Please follow the manufacturer's operating instructions when using autoclave. All machines used must comply with all current quality and other standards.
- c.) Instruments are being sterilized/ autoclaved at a temperature of 134°C.
- d.) Sterilization packing material must comply with all current standards.
- e.) Instruments with ratchets or self-retaining mechanisms should be sterilized opened or in the first ratchet position.
- f.) Please ensure that perforated instrument trays, when loaded do not exceed 10 kg in weight.

5. IN GENERAL

- a.) All surgical instruments supplied by us have been thoroughly inspected before dispatch and leave our factory in perfect condition. Damage which can arise as a result of transporting, cleaning, preserving, sterilizing or storing, must be prevented.
- b.) Please handle surgical instruments always with the utmost care.
- c.) Instruments must be stored in a clean and dry place.
- d.) If you have any queries or problems please contact us at any time:

We should like to point out that, if the above-mentioned directions are not followed or the instruments supplied by us are not properly used, all guarantee claims become void and any consequences must be borne by yourselves.

SUGERENCIAS PARA LA LIMPIEZA, ESTERILIZACIÓN Y MANTENIMIENTO DE INSTRUMENTOS QUIRÚRGICOS

ENJUAGADO

Tras el uso enjuagar enseguida los instrumentos bajo un chorro de agua caliente (no hirviendo). El enjuagado debe servir para quitar los residuos de sangre, mucosas y tejidos.

LIMPIEZA

Si la limpieza no se efectúa inmediatamente después del enjuagado, los instrumentos tienen que sumergirse en una solución de agua y detergente con PH neutro (7)

Para los instrumentos muy delicados (algunos tipos de porta agujas o tijeras se aconseja una limpieza manual: ver punto "C").

a.- Limpieza en la pila de ultrasonido

Los instrumentos tienen que estar en la pila el tiempo necesario recomendado por el fabricante para efectuar el ciclo del lavado, generalmente de 5 a 10 minutos.

Los instrumentos con bisagras o juntas (articulaciones) tienen que sumergirse en la pila en posición abierta.

Asegurarse de que las hojas afiladas de las tijeras, bisturíes para gingivectomía, curetas, etc. no estén en contacto con otros instrumentos.

Todos los instrumentos deben estar completamente sumergidos en la solución de lavado.

No poner instrumentos de diferentes metales (acero inoxidable, instrumentos cromados, latón, etc.) en el mismo ciclo de lavado.

Cambiar a menudo la solución para el lavado, como mínimo todas las veces que lo recomienda el fabricante de la pila de ultrasonidos.

Enjuagar concienzudamente los instrumentos con agua corriente tras lavado con ultrasonidos para quitar los residuos de la solución de lavado.

b.- Limpieza con lavadora

Seguir las indicaciones del fabricante. Asegurarse de que los instrumentos hayan sido lubricados tras el último ciclo de lavado y antes del ciclo de esterilización.

c.- Limpieza manual

La mayor parte de los fabricantes de instrumentos indican el lavado con los ultrasonidos como el modo mejor y más eficaz para limpiar los instrumentos quirúrgicos, especialmente los que tienen bisagras, cierres y en general articulaciones. Si la limpieza con los ultrasonidos no es posible, se aconseja usar el método siguiente:

- Usar cepillos rígidos de plástico, nylon, etc.
- Cepillar concienzudamente los instrumentos más delicados y, si es posible, enjuagar, limpiar y esterilizar estos instrumentos separadamente.
- Verificar que toda la superficie de estos instrumentos esté limpia.
- Tras haber cepillado los instrumentos, enjuagarlos bajo el chorro de agua corriente.
- Durante el enjuagado abrir y cerrar las tijeras, las pinzas hemostáticas, los porta agujas y los demás instrumentos con bisagras o juntas y asegurarse de que las partes internas de las bisagras estén perfectamente enjuagadas como la superficie externa del instrumento.

SECADO, LUBRIFICACIÓN E INSPECCIÓN

Tras las operaciones de limpieza y de enjuagado, los instrumentos quirúrgicos tienen que ser secados perfectamente.

Todos los instrumentos con juntas o bisagras (acción "metal contra metal") como tijeras, pinzas hemostáticas, porta agujas, fórceps de extracción, etc., tienen que ser lubricados. Se aconsejan lubricantes específicos para el instrumental quirúrgico. No usar aceites o lubricantes industriales.

A este punto es buena norma inspeccionar el estado de cada instrumento y verificar el funcionamiento según el uso específico. Controlar y asegurarse de que:

- Las hojas de las tijeras estén lisas de arriba abajo y de que, una vez cerradas, no hagan juego. Probar las tijeras cortando gasa muy fina. Tres cuartas parte de la hoja tienen que cortar la gasa sin tenerla.

- Las puntas de las pinzas estén al mismo nivel.

- Las pinzas hemostáticas y los porta agujas no dejen pasar la luz entre las puntas cuando estén cerradas, se abran y cierren fácilmente y que las bisagras no estén demasiado flojas.
- Controlar el desgaste de la porta agujas sobre la superficie interna de las puntas.
- Las cánulas metálicas de aspiración estén bien limpias en su interior.
- Los instrumentos cortantes y los bisturíes tengan las hojas bien afiladas y no estropeadas.

ESTERILIZACIÓN EN AUTOCLAVE

Tras haber enjuagado, limpiado, secado, lubricado e inspeccionado los instrumentos, éstos pueden ser preparados para la esterilización separadamente o en serie.

Instrumentos individuales:

Las bolsas especiales monouso son el ideal para contener los instrumentos. Asegurarse de que las bolsas que contendrán los instrumentos con cierres y articulaciones (pinzas hemostáticas, porta agujas, etc.) sean lo bastante grandes como para contener los citados instrumentos en posición abierta.

Instrumentos en serie:

Poner los instrumentos en los especiales cestos o bandejas de acero inoxidable. Poner los instrumentos más pesados en la parte inferior cuando sean necesarias varias bandejas.

No cerrar nunca los instrumentos durante el ciclo en autoclave. Un instrumento cerrado no estará nunca bien esterilizado, ya que el vapor no puede penetrar en la parte de cierre a contacto "metal contra metal". En el instrumento podría además romperse en la parte de la bisagra a causa de la expansión del metal debida al calor durante el ciclo del autoclave.

No cargar demasiado la cámara del autoclave ya que algunos instrumentos podrían formar "zonas de sombra" sobre otros en los que el vapor no penetraría.

ATENCIÓN

Al final del ciclo de esterilización - antes del ciclo de secado- abrir ligeramente la portezuela del autoclave y preceder con el ciclo desecado según las instrucciones del fabricante. Si la portezuela del autoclave se abriese completamente antes del ciclo de secado, el aire frío de la habitación entraría en la cámara del autoclave causando la formación de condensación sobre los instrumentos y de consecuencia aparecerían las manchas de agua que vemos a menudo en los mismos.

ESTERILIZACIÓN EN FRÍO:

La mayor parte de las soluciones para la esterilización en frío esterilizan los instrumentos completamente tras 10 horas de inmersión. Esta acción química prolongada puede ser más perjudicial para los instrumentos que el ciclo normal de 20 minutos en autoclave.

Si los instrumentos tienen necesidad de ser simplemente "desinfectados", el proceso en frío es adecuado, ya que la desinfección tiene lugar en 10 minutos solamente.

Recuerde bien la diferencia entre:

ESTÉRIL - término absoluto (ningún organismo logra sobrevivir) y

DESINFECTADO - perfectamente limpio.

Usen siempre la técnica más adecuada de esterilización/limpieza de los instrumentos según el uso que se haga posteriormente de ellos.

Recuerden que la esterilización de los instrumentos no sustituye la limpieza de los mismos.

Recomendamos no volver a usar ni esterilizar los artículos de un solo uso.

Si se tratan en el modo correcto los instrumentos contruidos con las modernas aleaciones inoxidables pueden durar muchos años.

INDICAZIONI PER LA CURA, PULITURA E LA STERILIZZAZIONE DELLO STRUMENTARIO CHIRURGICO RISTERILIZZABILE

Misure preventive anticorrosione

- 1) Raggruppare accuratamente gli strumenti correttamente confezionati e sterilizzati prima dell'operazione; selezionarli secondo l'intervento. Verificare sempre che la confezione esterna sia integra e che lo strumento stesso non sia danneggiato.
- 2) Assicurarsi tramite l'indicatore di sterilizzazione collocato all'interno del vaglio che il contenuto sia stato sterilizzato.
- 3) Disporre gli strumenti seguendo l'ordine di utilizzo durante l'operazione; lasciare gli strumenti non necessari nel vaglio; predisporre gli strumenti solo immediatamente prima dell'operazione.
- 4) Nel corso dell'operazione rimuovere dagli strumenti sangue ed altri materiali biologici; dopo l'uso, riporre gli strumenti nel corretto alloggiamento.
- 5) Risciacquare opportunamente gli strumenti cavi, al fine di evitare l'adesione di sangue e polvere d'osso.
- 6) Per la pulitura degli strumenti utilizzare una soluzione lattata o una soluzione salina, ma non immergerli nelle suddette soluzioni.
- 7) Iniziare l'operazione di pulitura subito dopo l'intervento. Strumenti utilizzati su pazienti con possibili infezioni: smaltire in modo analogo, eliminando sangue, polvere d'osso parti di tessuto in eccesso.
- 8) Pulire gli strumenti in un luogo previsto nell'ambito della sala operatoria.

Nel caso in cui gli strumenti vadano collocati direttamente nella centrale di sterilizzazione, è necessario dapprima coprirli, per evitare il rischio di contaminazione ai danni del personale o dell'ambiente circostante.

Disinfezione

Durante l'uso di disinfettanti chimici è necessario osservare scrupolosamente le indicazioni del produttore; utilizzare le soluzioni sempre previa diluizione. Nella fase termica di disinfezione con acqua bollente assicurarsi che l'acqua sia priva di corpi estranei.

Pulitura

Indipendentemente dal metodo utilizzato per la pulitura (meccanico o manuale) si raccomanda di verificare attentamente quale detergente vada utilizzato con ciascun metodo. Valori pH consigliati: tra 7,0 e 8,5.

1) Pulitura meccanica

Osservare scrupolosamente le istruzioni d'uso fornite dal produttore della macchina pulitrice. Predisporre gli

strumenti per la pulitura meccanica. Tutti gli strumenti appuntiti e delicati dovrebbero essere puliti manualmente.

Non sovraccaricare i vagli, mettere gli strumenti pesanti sul fondo del vaglio. Se necessario, immergere e risciacquare gli strumenti molto sporchi (strumenti cavi), prima di collocarli nella lavatrice.

2) Pulitura ad ultrasuoni

(fa parte dei metodi di pulitura meccanica)

Prima di inserire uno strumento nel bagno ad ultrasuoni, rimuovere i materiali organici in eccesso. I bagni ad ultrasuoni sono consigliati per le filettatrici o gli strumenti con solchi profondi. L'ultrasuono deve essere seguito da un programma di risciacquo normale.

3) Pulitura manuale

Richiede diverse spazzole in nylon, una canna da soffio ed un ugello da soffio/ un dispositivo ad aria compressa pulito, detergenti e solventi come per la pulitura meccanica.

Per gli additivi di pulitura osservare le indicazioni fornite dal produttore.

Per la pulitura degli strumenti dotati di cannula, passare più volte lo spazzolino di nylon attraverso la cannula eseguendo movimenti rotatori (non utilizzare spazzole in lana d'acciaio/metallo) fino alla completa rimozione dei residui eliminabili con questo metodo.

Soffiare poi con aria compressa nella cannula.

4) Asciugatura

Ogni strumento deve essere asciugato completamente sia internamente che esternamente per evitare la formazione di ruggine o malfunzionamenti.

Indicazioni per la sterilizzazione della strumentazione

Pulire immediatamente ed asciugare bene gli strumenti usati, non utilizzare detergenti e disinfettanti con additivi fortemente acidi o alcalini (ad es. soda, soda caustica o acidi)!

Sterilizzare la strumentazione solo a vapore A 134°!

Prima della sterilizzazione, assicurarsi che gli strumenti siano perfettamente funzionanti ed integri. La sterilizzazione non sostituisce la pulitura.

Markierungs- und Messinstrumente
Marking and Measuring Instruments
Instrumentos para marcar y medir
Strumenti per marcare e misurare



Winkelmesser
Goniometer
Goniómetro
Goniometro

MOELTGEN
03312-01
24 cm, 9 1/2"

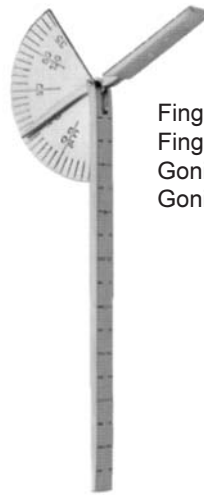

Finger-Goniometer
Finger goniometer
Goniómetro para dedos
Goniometro per le dita

03314-01
13 cm, 5 1/8"



03340-10	10 cm	4"
03340-15	15 cm	6"
03340-20	20 cm	8"
03340-30	30 cm	11 3/4"
03340-50	50 cm	19 3/4"

Markierungsinstrumente
Marking Instruments
Instrumentos para marcar
Strumenti per marcare

Facelift-Markierer
Facelift marker
Marcador para facelift
Marcatore per facelift



PITANGUY
03370-16
16 cm, 6¹/₄"



D'ASSUMPACO
03380-30
28 cm, 11"



LOCKWOOD
03390-30
32,5 cm, 12³/₄"

Markierungs- und Messinstrumente
Marking and Measuring Instruments
Instrumentos para marcar y medir
Strumenti per marcare e misurare



McKISSOCK
03400-38 38 mm, 1 $\frac{1}{2}$ "
03400-42 42 mm, 1 $\frac{2}{3}$ "
03400-45 45 mm, 1 $\frac{3}{4}$ "



FREEMAN
03500-38 38 mm, 1 $\frac{1}{2}$ "
03500-42 42 mm, 1 $\frac{2}{3}$ "
03500-44 45 mm, 1 $\frac{3}{4}$ "



CASTROVIEJO
43583-07 7 cm, 2 $\frac{3}{4}$ "
43583-18 18 cm, 7"
0-20 mm



COLLIER
73193-30
30 cm, 11 $\frac{3}{4}$ "

Dermatome
Dermatome
Dermàtomo
Dermatomo



SCHINK
07490-00
30 cm, 11³/₄"

compl.
mit/with/con
07490-01 (1) Stk./pcs
07490-02 (2) Stk./pcs



07490-01

Ersatzklinge
Spare blade
Hoja de repuesto
Lama di ricambio per dermatomo

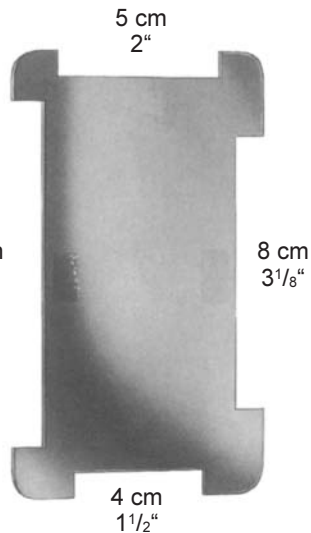

07490-02

Spannplatte
Skin straightening plate
Placa para extender la piel
Placca per stendipelle

Dermatome
Dermatome
Dermátomo
Dermatomo



HUMBY
07495-31
31 cm, 12¹/₄"



SILVER
07498-00
19 cm, 7¹/₂"



WATSON
07499-00
30 cm, 11³/₄"

Ersatzklingen, unsteril / Spare blade, non sterile
Hoja de repuesto, no esteril / Lama di ricambio, non sterile

07496-31

07296-00

07499-01

Skalpellgriffe
Scalpel Handles
Mangos de bisturíes
Manici per lama bisturi

passend zu den Klängen
for blades
para las hojas
per lama bisturi

(A) No. 10, 11, 12, 13, 14, 15, 16, 17, 18, 19



07103-00
Fig. 3

(A)



07103-01
Fig. 3 grad

(A)



07103-02
Fig. 3 L

(A)



07103-03
Fig. 3 L

(A)

Skalpelli
Scalpel Handles
Mangos de bisturíes
Manici per lama bisturi

passend zu den Klagen
for blades
para las hojas
per lama bisturi

(A) No. 10, 11, 12, 13, 14, 15, 16, 17, 18, 19

(B) No. 20, 21, 22, 23, 24, 25



07104-00
Fig. 4

(B)



07104-02
Fig. 4 L

(B)



07105-02
Fig. 4 L

(B)



07106-01
Fig. 3

(A)

Skalpellgriffe
Scalpel Handles
Mangos de bisturíes
Manici per lama bisturi

passend zu den Klängen
for blades
para las hojas
per lama bisturi

(A) No. 10, 11, 12, 13, 14, 15, 16, 17, 18, 19

(B) No. 20, 21, 22, 23, 24, 25



07107-00
Fig. 7

(A)



07107-01
Fig. 7K

(A)



07108-00
Fig. 8

(B)

Mini-Skalpellgriffe/Skalpellklingen
Scalpel Handles
Mangos de bisturios
Manici per lama bisturi/lame per bisturi



07161-00 07162-00 07165-00 07167-00

Packung mit 10 Stück
box of 10
en cajas de 10 unidades
confezione di 10 pezzi

07109-10 10,0 cm, 4"
07109-13 13,0 cm, 5¹/₈"
07109-15 15,5 cm, 6"

Skalpellgriffe
Scalpel Handles
Mangos de bisturios
Manici per lama bisturi



LANDOLT
93385-21 21 cm, 8¹/₄"
93385-25 25 cm, 10"

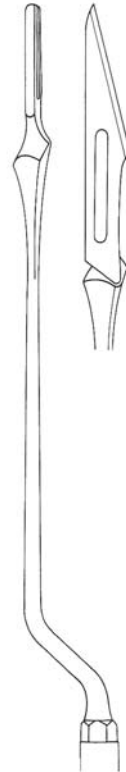

93390-21 21 cm, 8¹/₄"

Präparierscheren
Dissecting Scissors
Tijeras de disección
Forbici per dissezione



MAYO



09160-14

14 cm, 5 $\frac{1}{2}$ "

09164-14 TC

14 cm, 5 $\frac{1}{2}$ "

09962-14 SC

14 cm, 5 $\frac{1}{2}$ "



09161-14

09165-14 TC

09963-14 SC

09160-17

17 cm, 6 $\frac{3}{4}$ "

09164-17 TC

17 cm, 6 $\frac{3}{4}$ "

09962-17 SC

17 cm, 6 $\frac{3}{4}$ "

09161-17

09165-17 TC

09963-17 SC

Präparierscheren
 Dissecting Scissors
 Tijeras de disección
 Forbici per dissezione



MAYO-STILLE



09170-15

15 cm, 6"

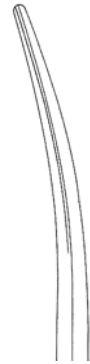

09171-15

09174-15 TC 15 cm, 6" **09175-15 TC**

09964-15 SC

15 cm, 6"

09965-15 SC



09170-17

17 cm, 6³/₄"



09171-17

09174-17 TC 17 cm, 6³/₄" **09175-17 TC**

09964-17 SC



17 cm, 6³/₄"

09965-17 SC

Präparierscheren
Dissecting Scissors
Tijeras de disección
Forbici per dissezione





LEXER

		
09190-16	16 cm, 6 $\frac{1}{4}$ "	09191-16
09194-16 TC	16 cm, 6 $\frac{1}{4}$ "	09195-16 TC



LEXER-BABY

		
09202-10	10 cm, 4"	09203-10
09206-10 TC	10 cm, 4"	09207-10 TC

Präparierscheren
 Dissecting Scissors
 Tijeras de disección
 Forbici per dissezione



METZENBAUM



09280-12	12 cm, 4 ³ / ₄ "	09281-12
09284-12 TC	12 cm, 4³/₄"	09285-12 TC
09966-11 SC	12 cm, 4³/₄"	09967-11 SC
09280-15	15 cm, 6"	09281-15
09284-15 TC	15 cm, 6"	09285-15 TC
09970-14 SC	15 cm, 6"	09971-14 SC
09280-18	18 cm, 7"	09281-18
09284-18 TC	18 cm, 7"	09285-18 TC
09970-18 SC	18 cm, 7"	09971-18 SC
09280-20	20 cm, 8"	09281-20
09284-20 TC	20 cm, 8"	09285-20 TC
09970-20 SC	20 cm, 8"	09971-20 SC
09280-23	23 cm, 9"	09281-23
09284-23 TC	23 cm, 9"	09285-23 TC
09970-23 SC	23 cm, 9"	09971-23 SC

Präparierscheren
Dissecting Scissors
Tijeras de disección
Forbici per dissezione



METZENBAUM



09270-15
09270-18

15 cm, 6"
18 cm, 7"



09271-15
09271-18

09274-15 TC
09274-18 TC

15 cm, 6"
18 cm, 7"

09275-15 TC
09275-18 TC



METZENBAUM-FINO



09282-15
09286-15 TC

15 cm, 6"
15 cm, 6"



09283-15
09287-15 TC

09282-18
09286-18 TC

18 cm, 7"
18 cm, 7"

09283-18
09287-18 TC

09282-20
09286-20 TC

20 cm, 8"
20 cm, 8"

09283-20
09287-20 TC

09282-23
09286-23 TC

23 cm, 9"
23 cm, 9"

09283-23
09287-23 TC

Präparierscheren
Dissecting Scissors
Tijeras de disección
Forbici per dissezione



SANVENERO



09302-14

14 cm, 5 1/2"



09303-14



JOSEPH



09304-14

14 cm, 5 1/2"



09305-14

Präparierscheren
Dissecting Scissors
Tijeras de disección
Forbici per dissezione



- | | |
|--------------------|---|
| 09310-12 | 12 cm, 4 ³ / ₄ " |
| 09314-12 TC | 12 cm, 4³/₄" |
| 09995-12 SC | 12 cm, 4³/₄" |
| 09310-15 | 15 cm, 6" |

KILNER (RAGNELL)

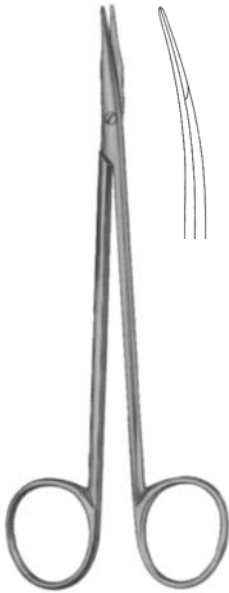

- | | |
|--------------------|------------------|
| REYNOLDS (JAMESON) | |
| 09321-15 | 15 cm, 6" |
| 09993-15 SC | 15 cm, 6" |
| 09321-18 | 18 cm, 7" |

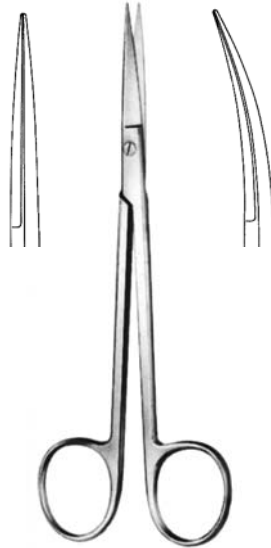

- | | | |
|--------------------|---|--------------------|
| KELLY | | |
| 09540-16 | 16 cm, 6 ¹ / ₄ " | 09541-16 |
| 09542-16 TC | 16 cm, 6¹/₄" | 09543-16 TC |
| 09544-16 SC | 16 cm, 6¹/₄" | 09545-16 SC |

Feine Scheren
 Delicate Scissors
 Tijeras finas
 Forbici delicate



IRIS

09340-09	9 cm, 3 ¹ / ₂ "	09341-09
09340-10	10 cm, 4"	09341-10
09340-11	11 cm, 4 ³ / ₈ "	09341-11
09344-11 TC	11 cm, 4³/₈"	09345-11 TC
09980-11 SC	11 cm, 4³/₈"	09981-11 SC



BONN

09342-08 8 cm, 3¹/₈" 09343-08

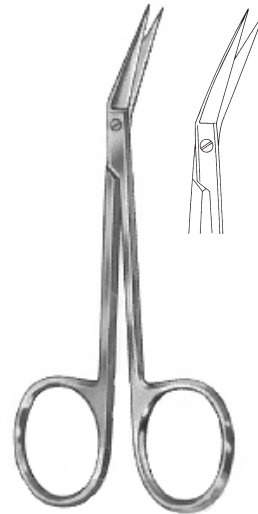

IRIS

09346-11
 11 cm, 4³/₈"

Feine Scheren
Delicate Scissors
Tijeras finas
Forbici delicate



KNAPP
10 cm, 4"



09348-01



09348-02



09348-03



09348-04



09348-05



09348-06

Feine Scheren
Delicate Scissors
Tijeras finas
Forbici delicate



LITTLER
09349-12
12 cm, 4³/₄"



GRAEFE
09350-10
10 cm, 4"

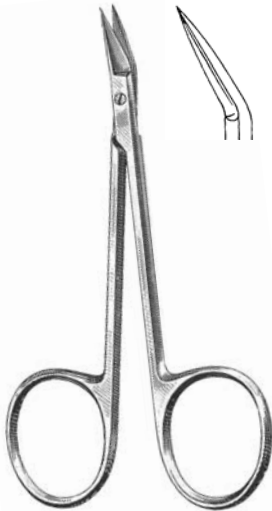

CONVERSE/WILMER/WALTER
09352-10
10 cm, 4"



COTTLE
09358-11
11 cm, 4³/₈"

Feine Scheren
Delicate Scissors
Tijeras finas
Forbici delicate

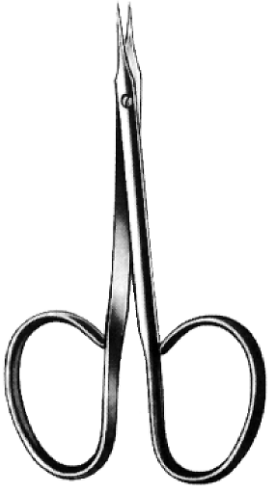

GRADLE
09350-09 9,5 cm, 3³/₄" 09351-09

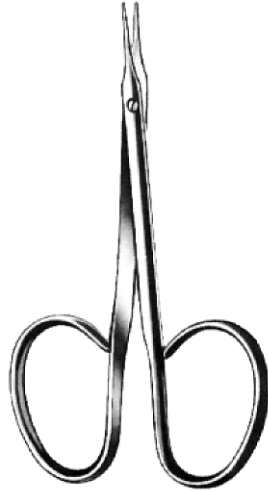

09352-09 9,5 cm, 3³/₄" 09353-09



09354-10 10 cm, 4" 09355-10



09356-10 10 cm, 4" 09357-10

Feine Scheren
 Delicate Scissors
 Tijeras finas
 Forbici delicate

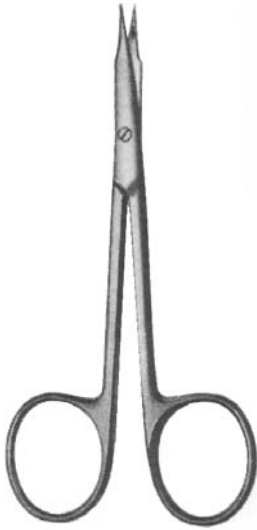

STEVENS
 11 cm, 4³/₈"

spitz
 sharp
 agudo
 acuti



09360-11
09984-11SC



09361-11
09985-11 SC



stumpf
 blunt
 romo
 smussi



09362-11



09363-11

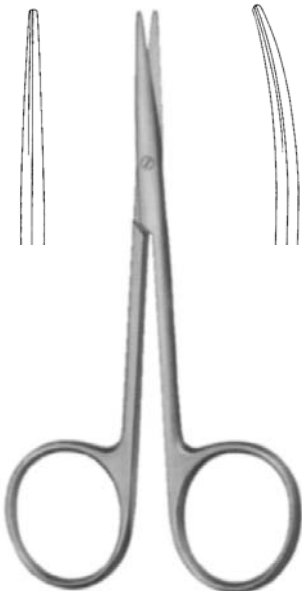

STRABISMUS

- 09370-11 11 cm, 4³/₈" 09371-11
 09374-11TC 11 cm, 4³/₈" 09375-11TC

Feine Scheren
Delicate Scissors
Tijeras finas
Forbici delicate



WAGNER
12 cm, 4³/₄"



09828-12



09826-12



09824-12

09982-12SC



WAGNER
12 cm, 4³/₄"



09823-12



09829-12



09825-12

09983-12 SC

Zahnfleischscheren
Gum Scissors
Tijeras para encias
Forbici gengivali

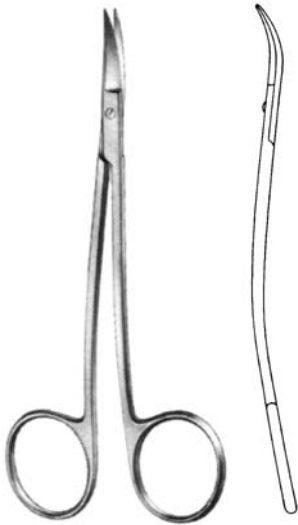

LA GRANGE
09854-11
11,5 cm, 4 1/2"



CHADWICK
09855-11
11,5 cm, 4 1/2"

Nasenscheren
Nasal Scissors
Tijeras nasales
Forbici nasali



HEYMAN
09401-18 18 cm, 7"



FOMON
09403-15 15 cm, 6"



COTTLE
09405-16 16 cm, 6 1/4"
09405-16TC 16 cm, 6 1/4"

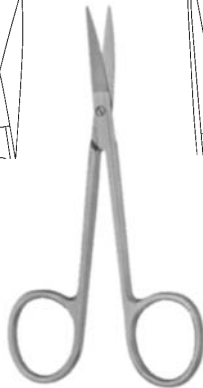
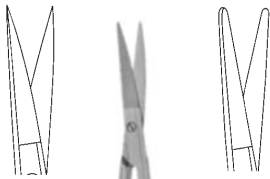

COTTLE-MASING
09406-10 10 cm, 4" 09407-10



FOMON
09617-13 13 cm, 5 1/8"

Fadenscheren
Stitch Scissors
Tijeras para hilos
Forbici taglia fili



SPENCER
09802-09 9 cm, 3 $\frac{1}{2}$ "
09802-11 11 cm, 4 $\frac{3}{8}$ "



LITTAUER
09804-14
14 cm, 5 $\frac{1}{2}$ "



O'BRIEN
09805-09
9 cm, 3 $\frac{1}{2}$ "

Knorpelscheren/Zahnfleischscheren
Cartilage Scissors/Gum Scissors
Tijeras para cartilago/Tijeras para encías
Forbici per cartilagine/Forbici gengivali



MC INDOE
09614-19
19 cm, 7 1/2"

1 Schneide gezahnt
1 blade toothed
1 hoja dentada
1 taglio dentellato



09820-13



GOLDMAN-FOX
13 cm, 5 1/8"

09821-13
09821-13SC

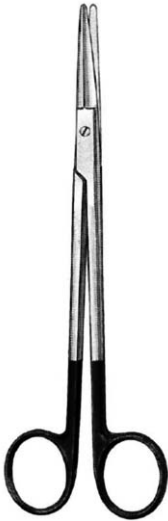
Face-Lift Scheren
 Face-Lift Scissors
 Face Lift tijeras
 Face Lift forbici



GORNEY

		
10010-19	19 cm, 7 1/2"	10011-19
10012-19 TC	19 cm, 7 1/2"	10013-19 TC
10014-19 SC	19 cm, 7 1/2"	10015-19 SC



GORNEY-FREEMAN

10061-19	19 cm, 7 1/2"
10061-19 TC	19 cm, 7 1/2"
10061-19 SC	19 cm, 7 1/2"
10061-23	23 cm, 9"
10061-23 TC	23 cm, 9"
10061-23 SC	23 cm, 9"

Face-Lift Scheren
 Face-Lift Scissors
 Face-Lift tijeras
 Face Lift forbici



KAYE

10028-14 TC	14 cm, 5½"	10029-14 TC
10034-14 SC	14 cm, 5½"	10035-14 SC
10030-18 TC	18 cm, 7"	10031-18 TC
10036-18 SC	18 cm, 7"	10037-18 SC
10032-23 TC	23 cm, 9"	10033-23 TC
10038-23 SC	23 cm, 9"	10039-23 SC



PECK-JOSEPH

10044-14	14,5 cm, 5¾"	10045-14
10048-14 SC	14,5 cm, 5¾"	10049-14 SC



BEUSE

10050-14	14 cm, 5½"	10051-14
10050-18	18 cm, 7"	10051-18

Blepharoplastik Scheren
Blepharoplasty Scissors
Tijeras para blefaroplastia
Forbici per blefaroplastica



GREENBERG-PAR

10201-11 11,5 cm 4½"
10201-11SC 11,5 cm 4½"



KAYE

10206-11 11,5 cm, 4½"
10206-11SC 11,5 cm, 4½" 10207-11
10207-11SC

Mikro Scheren
 Micro Scissors
 Micro tijeras
 Micro Forbice

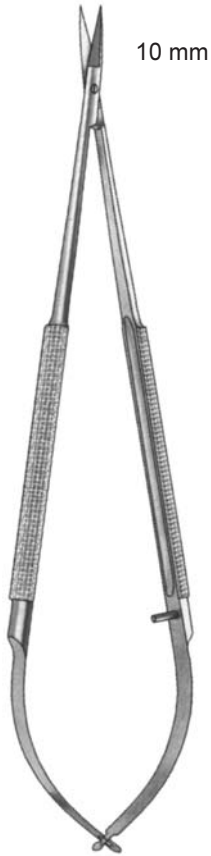

	—	⤿
11 cm 4 ³ / ₈ "	10202-11	10203-11
14,5 cm 5 ³ / ₄ "	10202-14 10202-14T	10203-14 10203-14T
18 cm 7"	10202-18 10202-18T	10203-18 10203-18T
21 cm 8 ¹ / ₄ "	10202-21 10202-21T	10203-21 10203-21T
23 cm 9"	10202-23	10203-23

T= Titan, titanium, titanio, titanio

Mikro Scheren
Micro Scissors
Micro tijeras
Micro Forbice

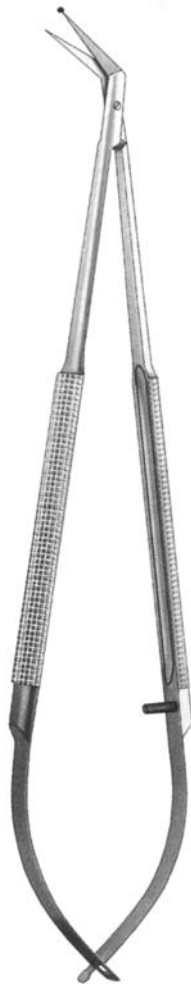

18 cm 7"



25°

10220-25

10220-25T



45°

10220-45

10220-45T

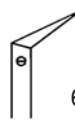

60°

10220-60

10220-60T

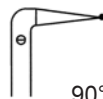

90°

10220-90

10220-90T



125°





10220-00

10220-00T

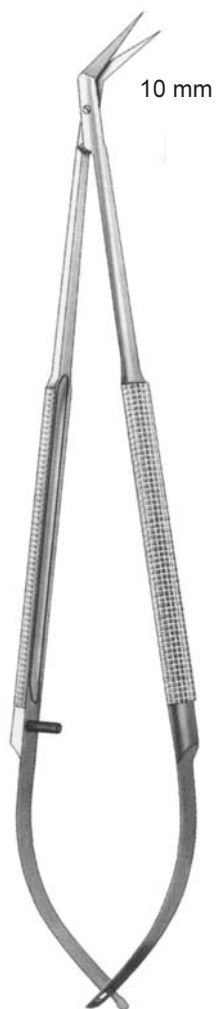
T= Titan, titanium, titanio, titanio

Mikro Scheren
Micro Scissors
Micro tijeras
Micro Forbice

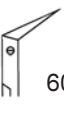

	11 cm 4 ³ / ₈ "	14,5 cm 5 ³ / ₄ "	18 cm 7"	21 cm 8 ¹ / ₄ "	23 cm 9"
 25°	10226-11	10226-14	10226-18 10226-18T	10226-21	10226-23
 45°	10227-11	10227-14	10227-18 10227-18T	10227-21	10227-23
 60°	10228-11	10228-14	10228-18 10228-18T	10228-21	10228-23
 90°	10229-11	10229-14	10229-18 10229-18T	10229-21	10229-23
 125°	10230-11	10230-14	10230-18 10230-18T	10230-21	10230-23

T= Titan, titanium, titanio, titanio

Anatomische und chirurgische Pinzetten
 Dressing and Tissue Forceps
 Pinzas de disección sin/con dientes
 Pinze per dissezione, chirurgiche/anatomiche



STANDARD

USA

STILLE

cm

10,5 4 1/4"

11102-10

11,5 4 1/2"

11102-11

12,0 4 3/4"

11104-12

13,0 5 1/8"

11102-13

11104-13

11106-13

14,5 5 3/4"

11102-14

11103-14

11104-14

15,0 6"

11106-15

15,5 6"

11104-15

16,0 6 1/4"

11102-16

18,0 7"

11102-18

11104-18

20,0 8"

11102-20

21,0 8 1/4"

11104-21



schmal
 narrow
 estrecha
 stretta



POTTS-SMITH



POTTS-SMITH
 1x2

cm

11,5 4 1/2"

11110-11

13,0 5 1/8"

11110-13

14,5 5 3/4"

11110-14

11114-14 TC

16,0 6 1/4"

11110-16

11114-16 TC

18,0 7"

11110-18

11112-18

11116-18 TC

11126-18

20,0 8"

11110-20

11114-20 TC

21,0 8 1/4"

11110-25

11114-25 TC

11112-21

11116-21 TC

11126-21

25,0 10"

11110-25

11114-25 TC

11112-25

11116-25 TC

11126-25

Chirurgische Pinzetten
Tissue Forceps
Pinzas de disección con dientes
Pinze per dissezione, chirurgiche

STANDARD	1x2	USA	1x2	STILLE	1x2	schmal narrow estrecha stretta	1x2
cm							
10,5	4 1/4"	11120-10					
11,5	4 1/2"	11120-11				11130-11	
12,0	4 3/4"		11122-12				
13,0	5 1/8"	11120-13	11122-13			11130-13	
14,5	5 3/4"	11120-14	11122-14			11130-14	
15,0	6"			11124-15			
15,5	6"		11122-15				
16,0	6 1/4"	11120-16				11130-16	
18,0	7"	11120-18	11122-18			11130-18	
20,0	8"	11120-20				11130-20	
21,0	8 1/4"		11122-21				

	OEHLER	2x3	3x4	4x5
cm				
11,5	4 1/2"	11140-11		
13,0	5 1/8"	11140-13	11150-13	11160-13
14,5	5 3/4"	11140-14	11150-14	11160-14
16,0	6 1/4"	11132-16 TC	11140-16	11150-16
18,0	7"	11132-18 TC	11140-18	11160-16
20,0	8"	11132-20 TC	11140-20	

Anatomische und chirurgische Pinzetten
 Dressing and Tissue Forceps
 Pinzas de disección sin/con dientes
 Pinze per dissezione, chirurgiche/anatomiche



ADSON
 11170-12 12,0 cm, 4 3/4"
 11170-15 15,0 cm, 6"



ADSON
 11170-12F 12 cm, 4 3/4"

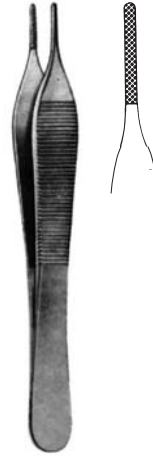

ADSON
 11174-12 TC 12,0 cm, 4 3/4"
 11174-15 TC 15,0 cm, 6"



ADSON micro
 11176-12 12,0 cm, 4 3/4"
 11176-15 15,0 cm, 6"



ADSON-DeBAKEY atraumatic
 11177-12
 12,0 cm, 4 3/4"



ADSON
 11178-12
 12,0 cm, 4 3/4"

1x2



ADSON
 11179-12
 12 cm, 4 3/4"

2x3

Chirurgische Pinzetten
Tissue Forceps
Pinzas de disección con dientes
Pinze per dissezione, chirurgiche



1x2

ADSON
11180-12 12,0 cm, 4 3/4"
11180-15 15,0 cm, 6"



1x2

ADSON
11180-12F 12 cm, 4 3/4"

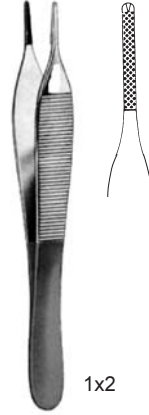

1x2

ADSON
11181-12 TC 12,0 cm, 4 3/4"
11181-15 TC 15,0 cm, 6"



BEASELEY BABCOCK
11182-12 12 cm, 4 3/4"



1x2

ADSON micro
11186-12 12,0 cm, 4 3/4"
11186-15 15,0 cm, 6"



1x2

ADSON
11187-12 12 cm, 4 3/4"

Chirurgische Pinzetten
Tissue Forceps
Pinzas de disección con dientes
Pinze per dissezione, chirurgiche



7x7

ADSON-BROWN

11188-12 12,0 cm, 4 3/4"

11188-15 15,0 cm, 6"

11189-12 TC 12,0 cm, 4 3/4"



7x7

ADSON-BROWN

11188-12F 12 cm, 4 3/4"

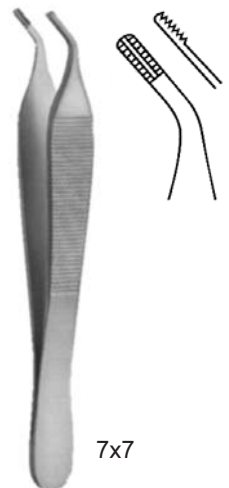

7x7

ADSON-BROWN

11191-12 12 cm, 4 3/4"

Anatomische und chirurgische Pinzetten
 Dressing and Tissue Forceps
 Pinzas de disección sin/con dientes
 Pinze per dissezione, chirurgiche/anatomiche



1x2

WAUGH

- 11187-18 18 cm, 7"
- 11187-20 20 cm, 8"
- 11187-25 25 cm, 10"
- 11187-30 30 cm, 11 3/4"



9x9

BROWN

- 11189-15 15,0 cm, 6"
- 11189-20 20,0 cm, 8"
- 11189-25 25,0 cm, 10"



GRAEFE

- 11190-10 10,5 cm, 4.1"



11221-17

CUSHING
 11220-17

- 11224-17 TC**
 17,0 cm, 6 3/4"



11223-17

CUSHING
 11222-17

- 11225-17 TC**
 17,0 cm, 6 3/4"



5x6

LERCHE
 11232-15
 15,0 cm, 6"

Anatomische und chirurgische Pinzetten
 Dressing and Tissue Forceps
 Pinzas de disección sin/con dientes
 Pinze per dissezione, chirurgiche/anatomiche



1x2

FERRIS-SMITH
 11246-18
 18,0 cm, 7"



2x3

FERRIS-SMITH
 11248-18
 18,0 cm, 7"



DUVAL
 11250-14
 14,5 cm, 5 3/4"



COLLIN-DUVAL
 11252-20
 20,0 cm, 8"



Russ. Mod.
 11256-15 15,0 cm, 6"
 11256-20 20,0 cm, 8"
 11256-25 25,0 cm, 10"



1x2

McINDOE
 11257-15
 15,0 cm, 6"



McINDOE
 11258-15 15,0 cm, 6"
 11259-15 TC 15,0 cm, 6"

Anatomische und chirurgische Pinzetten
 Dressing and Tissue Forceps
 Pinzas de disección sin/con dientes
 Pinze per dissezione, chirurgiche/anatomiche



SEMKEN
 11260-12 12,5 cm, 5"
 11260-15 15,5 cm, 6"
 11261-15 TC 15,5 cm, 6"



SEMKEN
 11270-12 12,5 cm, 5"
 11270-15 15,5 cm, 6"
 11271-15 TC 15,5 cm, 6"
 11271-18 TC 18 cm, 7"



GILLIES
 11272-15 15,5 cm, 6"
 11273-15 TC 15,5 cm, 6"



15,5 cm, 6"

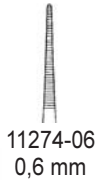

GERALD
 11302-17 17,5 cm, 6.9"
 11302-23 23,0 cm, 9"
 11304-17 TC 17,0 cm, 6 3/4"



GERALD
 11303-17
 17,5 cm, 6.9"

Anatomische und chirurgische Pinzetten
 Dressing and Tissue Forceps
 Pinzas de disección sin/con dientes
 Pinze per dissezione, chirurgiche/anatomiche



GERALD
 11305-17
 17,5 cm, 6.9"



GERALD
 11310-17 17,5 cm, 6.9"
 11312-17 TC 17,5 cm, 6.9"



GERALD
 11311-17
 17,5 cm, 6.9"



CUSHING-TAYLOR
 11312-18 TC
 18,5 cm, 7 1/4"



GERALD
 11313-17
 17,5 cm, 6.9"



11314-01



11314-02

TAYLOR
 17 cm, 6 3/4"



11315-01



11315-02

TAYLOR
 17 cm, 6 3/4"

Anatomische und chirurgische Pinzetten
 Dressing and Tissue Forceps
 Pinzas de disección sin/con dientes
 Pinze per dissezione, chirurgiche/anatomiche

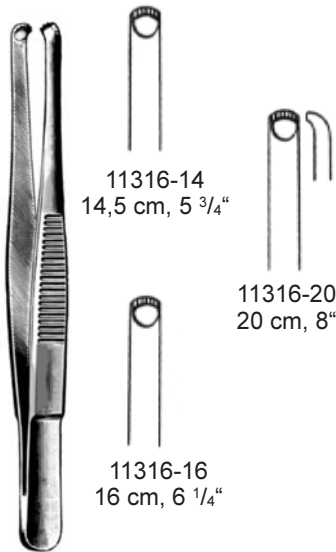

11316-14
 14,5 cm, 5 3/4"

11316-20
 20 cm, 8"

11316-16
 16 cm, 6 1/4"

DURANTE

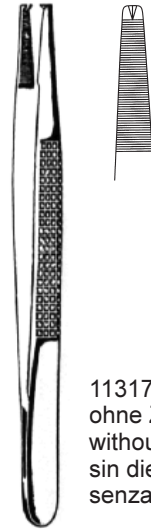

11317-12 1x2
 11317-23 2x3
 11319-12 TC 1x2

11317-00
 ohne Zähne
 without teeth
 sin dientes
 senza denti

BONNEY
 18 cm, 7"

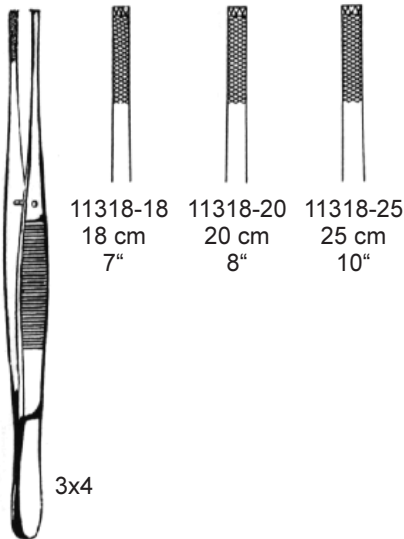

11318-18
 18 cm
 7"

11318-20
 20 cm
 8"

11318-25
 25 cm
 10"

3x4

STILLE-BARRAYA

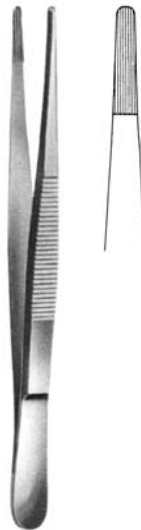

OCHSNER
 11319-14
 14,5 cm, 5 3/4"



SINGLEY
 11320-18 18 cm, 7"
 11320-23 23 cm, 9"

Splitterpinzetten
Splinter Forceps
Pinzas para espinas
Pinze per schegge

Fig.: 1



11401-01
12 cm, 4 3/4"

3



11403-03
12 cm, 4 3/4"

3c



11403-04
11 cm, 4 3/8"

Fig.: 4



11404-04
11 cm, 4 3/8"

5



11405-05
11 cm, 4 3/8"

7



11407-07
12 cm, 4 3/4"

Mikro- Knüpppinzetten
 Micro Suture Tying Forceps
 Micro pinzas para ligaduras
 Micro pinze per legature



	0,3 mm	0,8 mm
12 cm, 4 ³ / ₄ "	12102-12 12102-12D	
15 cm, 6"	12104-15 12104-15D	
18 cm, 7"		12108-18 12108-18D
21 cm, 8 ¹ / ₄ "	12102-21 12102-21D	
23 cm, 9"	12102-23 12102-23D	



	0,3 mm	0,8 mm
12 cm, 4 ³ / ₄ "	12103-12 12103-12D	
15 cm, 6"	12103-15 12103-15D	
18 cm, 7"		12109-18 12109-18D
21 cm, 8 ¹ / ₄ "	12109-21 12109-21D	
23 cm, 9"	12109-23 12109-23D	



1x2

	0,3 mm	0,3 mm
15 cm, 6"	12090-15D	12091-15D
	0,4 mm	0,4 mm
18 cm, 7"	12090-18D	12091-18D
	0,8 mm	0,8 mm
21 cm, 8 ¹ / ₄ "	12090-21D	12091-21D
23 cm, 9"	12090-23D	12091-23D



1x2

D = mit diamantiertem Maul
 with diamond jaw
 con boca de diamante
 con morso diamantato

Mikro- Ring-Pinzette mit diamantiertem Maul + TITAN
 Micro Ring Forceps with Diamond Jaw + Titanium
 Micro Pinzas con anillo con boca de diamante + Titanio
 Micro Pinza ad anello con morso diamantato +Titanio



	Ø 1 mm x 0,5 mm	Ø 2 mm x 1 mm
15 cm, 6"	12112-15D 12112-15T	12114-15D 12114-15T
18 cm, 7"	12112-18D 12112-18T	12114-18D 12114-18T
21 cm, 8 1/4"	12112-21D 12112-21T	12114-21D 12114-21T
23 cm, 9"	12112-23D 12112-23T	12114-23D 12114-23T

D = mit diamantiertem Maul
 with diamond jaw
 con boca de diamante
 con morso diamantato
 T = Titan, titanium, titanio, titanio

Atrauma- Mikro- Pinzette
 Atrauma Micro Forceps
 Micro pinza atraumaticas
 Micro Pinza Atraumatica

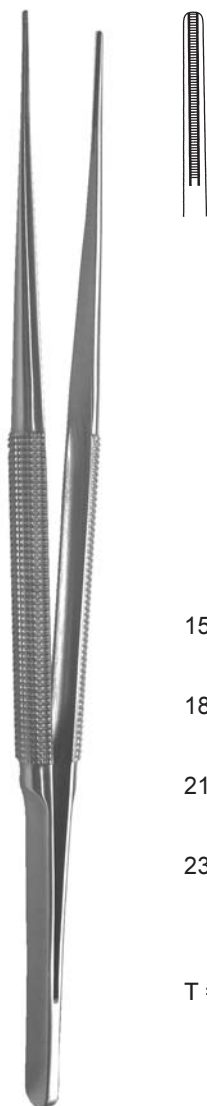

	1,2 mm	2,0 mm
15 cm, 6"	12115-15 12115-15T	12116-15
18 cm, 7"	12115-18 12115-18T	12116-18
21 cm, 8 ¹ / ₄ "	12115-21 12115-21T	12116-21
23 cm, 9"	12115-23 12115-23T	12116-23

T = Titan, titanium, titanio, titanio

De BAKEY

TC Atrauma Pinzette
TC Atrauma Forceps
Pinza atraumaticas con TC
Pinza Atraumatica TC



	1,2 mm	2,0 mm
18 cm, 7"	12117-18 TC	12118-18 TC
21 cm, 8 ¹ / ₄ "	12117-21 TC	12118-21 TC
23 cm, 9"	12117-23 TC	12118-23 TC

De BAKEY TC

Atraumatische Pinzetten
 Atraumatic Tissue Forceps
 Pinzas atraumaticas
 Pinze Atraumatiche



DE BAKEY
 12302-16 16 cm, 6 1/4"
 12302-20 20 cm, 8"
 12302-24 24 cm, 9 1/2"



DE BAKEY
 12306-16 16 cm, 6 1/4"
 12306-20 20 cm, 8"
 12306-24 24 cm, 9 1/2"
 12306-30 30 cm, 11 3/4"



DE BAKEY
 12308-16 16 cm, 6 1/4"
 12308-20 20 cm, 8"
 12308-24 24 cm, 9 1/2"
 12308-30 30 cm, 11 3/4"



DE BAKEY
 12309-16 16 cm, 6 1/4"
 12309-20 20 cm, 8"
 12309-24 24 cm, 9 1/2"
 12309-30 30 cm, 11 3/4"

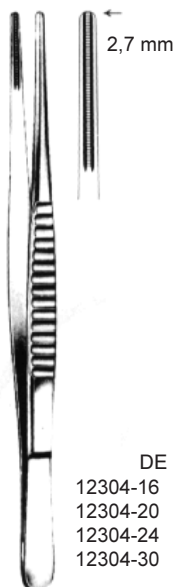

DE BAKEY
 12304-16 16 cm, 6 1/4"
 12304-20 20 cm, 8"
 12304-24 24 cm, 9 1/2"
 12304-30 30 cm, 11 3/4"

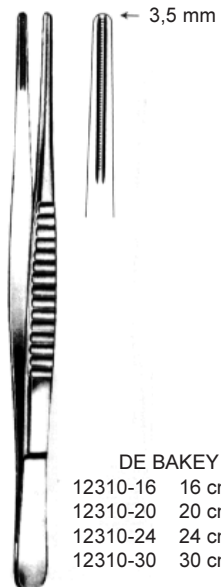

DE BAKEY
 12310-16 16 cm, 6 1/4"
 12310-20 20 cm, 8"
 12310-24 24 cm, 9 1/2"
 12310-30 30 cm, 11 3/4"

Iris Pinzetten
Iris Forceps
Pinzas para iris
Pinze per iride



GRAEFE
43810-10
10 cm, 4"



GRAEFE
43811-10
10 cm, 4"



GRAEFE
43813-10
10 cm, 4"



1x2

GRAEFE
43820-10
10 cm, 4"



1x2

GRAEFE
43821-10
10 cm, 4"



1x2

GRAEFE
43823-10
10 cm, 4"

Iris Pinzetten
Iris Forceps
Pinzas para iris
Pinze per iride



BISHOP-HARMAN
43940-05 8,5 cm, 3.4"
0,5 mm



BISHOP-HARMAN
43940-08 8,5 cm, 3.4"
0,8 mm



BISHOP-HARMAN
43942-05 8,5 cm, 3.4"
0,5 mm

1x2



BISHOP-HARMAN
43942-08 8,5 cm, 3.4"
0,8 mm

1x2

Nahtpinzetten
Suture forceps
Pinzas para sutura
Pinza per sutura



MOD. TUEBINGEN
43950-10
10 cm, 4"



1x2

MOD. BONN
43952-10
10 cm, 4" / 0,12 mm



MOD. TUEBINGEN
43953-10
10 cm, 4"

Muskelpinzetten, Nahtpinzetten, Chalazionspinzetten, Cilienpinzetten
 Muscle Forceps, Suture forceps, Forceps for Chalazion, Cilia Forceps
 Pinzas musculares, Pinza para sutura, Pinzas de chalazión, Pinza depilatorias
 Pinza muscolare, Pinza per sutura, Pinze per calazio, Pinza depilatoria

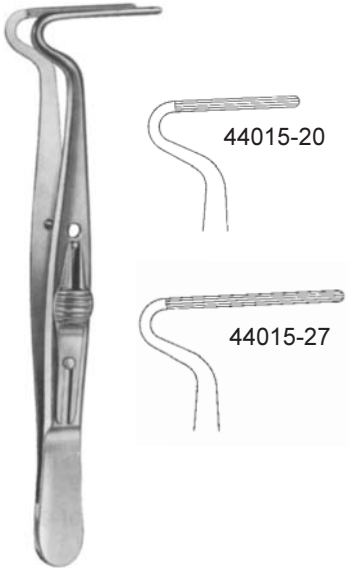

BERKE
 10 cm, 4"

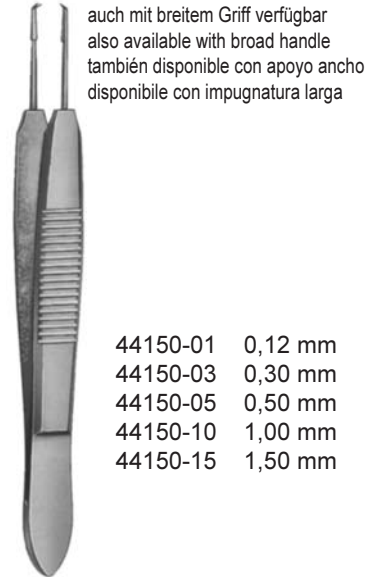

- 44150-01 0,12 mm
- 44150-03 0,30 mm
- 44150-05 0,50 mm
- 44150-10 1,00 mm
- 44150-15 1,50 mm

CASTROVIEJO
 10 cm, 4"

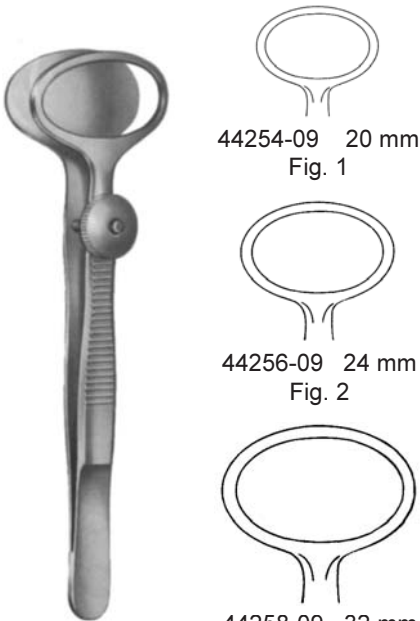

DESMARRES
 9 cm, 3 1/2"



BARRAQUER
 44425-10 10,5 cm, 4.1"

Fixierpinzetten
Fixation forceps
Pinzas para fijación
Pinze fissatrici



GREEN
10 cm, 4"

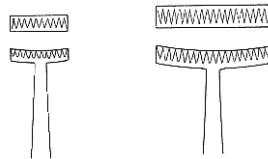

44076-05
5 mm

44076-10
10 mm

ohne Sperre
without catch
sin cierre
senza cremagliera

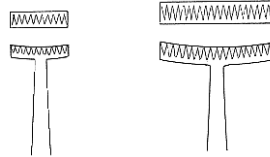

44078-05
5 mm

44078-10
10 mm

mit Sperre
with catch
con cierre
con cremagliera

Ohrpinzetten, Columellapinzette
 Ear Forceps, Columella Forceps
 Pinzas auriculares, Pinza para columela
 Pinze auricolari, Pinza per columella



WILDE (TROELTSCH)
 45201-11 11 cm, 4³/₈"



LUCAE
 45206-14 14 cm, 5¹/₂"
 45206-16 16 cm, 6¹/₄"



COTTLE
 45208-14 14 cm, 5¹/₂"



TROELTSCH
 47151-15 15 cm, 6"
 47151-18 18 cm, 7"



JANSEN-GRUENWALD
 47154-20 20 cm, 8"



COTTLE
 47565-10 10 cm, 4"

Lidplatte
Lid Plate
Placa para párado
Placca per palpebre



JAEGER
43150-11 11 cm, 4³/₈"

Arterienklemmen
Artery Forceps
Pinzas hemostáticas
Pinze emostatiche



HARTMANN
13210-10 10 cm, 4"

Micro - HARTMANN
13214-10 10 cm, 4"



HARTMANN
13211-10 10 cm, 4"

Micro - HARTMANN
13215-10 10 cm, 4"

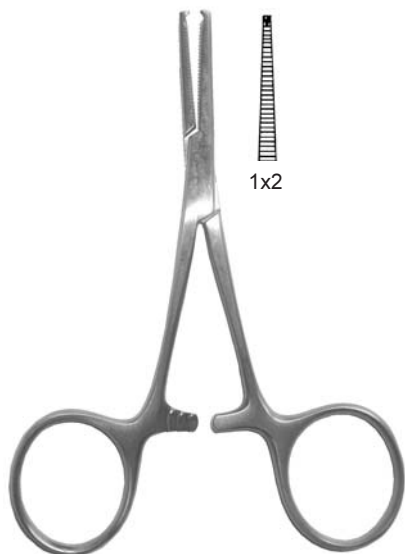

HARTMANN
13212-10 10 cm, 4"

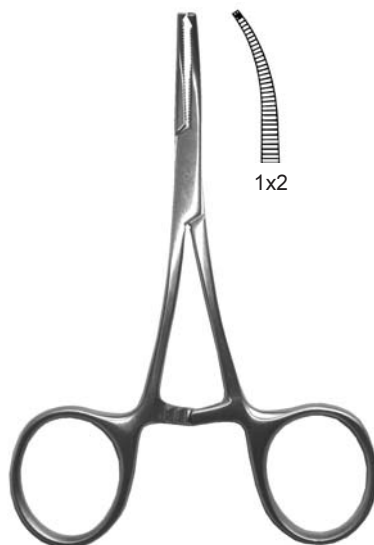

HARTMANN
13213-10 10 cm, 4"

Arterienklemmen
 Artery Forceps
 Pinzas hemostáticas
 Pinze emostatiche

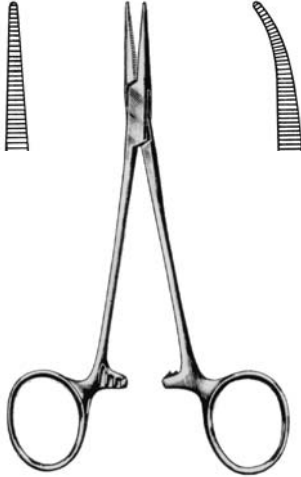

HALSTED-MOSQUITO

- | | | | | |
|------------------|----------|--------------|----------|------------------|
| 13224-12T | 13220-12 | 12,5 cm, 5" | 13221-12 | 13225-12T |
| | 13220-14 | 14,0 cm, 5½" | 13221-14 | |
| | 13220-18 | 18,0 cm, 7" | 13221-18 | |
| | 13220-21 | 21,0 cm, 8¼" | 13221-21 | |

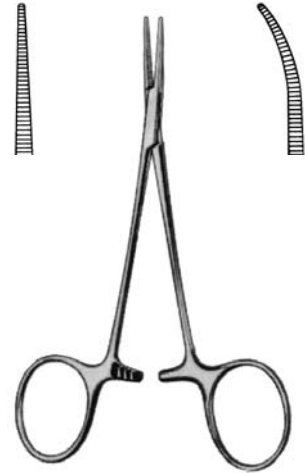

HALSTED-MOSQUITO micro

- | | | |
|----------|-------------|----------|
| 13222-12 | 12,5 cm, 5" | 13223-12 |
|----------|-------------|----------|

JACOBSEN micro

- | | | |
|----------|--------------|----------|
| 13226-12 | 21,0 cm, 8¼" | 13227-12 |
|----------|--------------|----------|

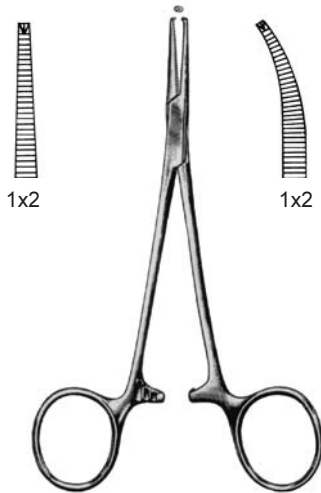

HALSTED-MOSQUITO

- | | | |
|----------|--------------|----------|
| 13230-12 | 12,5 cm, 5" | 13231-12 |
| 13230-14 | 14,0 cm, 5½" | 13231-14 |
| 13230-18 | 18,0 cm, 7" | 13231-18 |
| 13230-21 | 21,0 cm, 8¼" | 13231-21 |

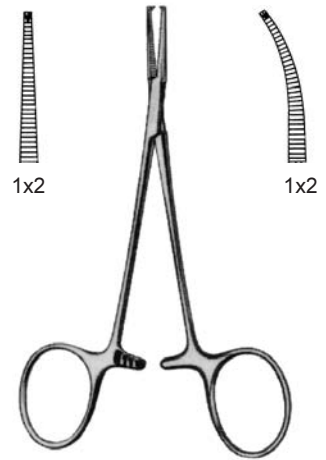

HALSTED-MOSQUITO micro

- | | | |
|----------|------------|----------|
| 13232-12 | 12 cm, 4¾" | 13233-12 |
|----------|------------|----------|

Arterienklemmen
 Artery Forceps
 Pinzas hemostáticas
 Pinze emostatiche

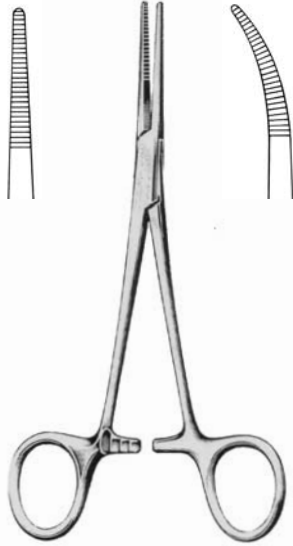

KELLY

- | | | |
|----------|---------------|----------|
| 13240-14 | 14 cm, 5 1/2" | 13241-14 |
| 13240-18 | 18 cm, 7" | 13241-18 |
| 13244-14 | 14 cm, 5 1/2" | 13245-14 |

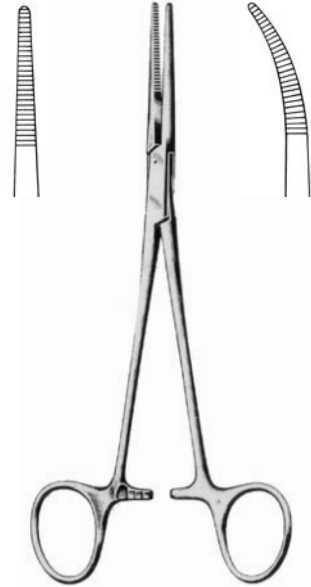

KELLY-RANKIN

- | | | |
|----------|---------------|----------|
| 13242-16 | 16 cm, 6 1/4" | 13243-16 |
|----------|---------------|----------|

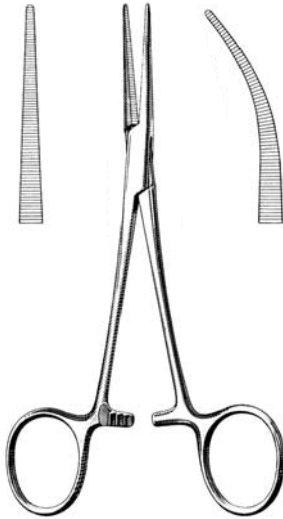

COLLER-CRILE

- | | | |
|----------|---------------|----------|
| 13256-14 | 14 cm, 5 1/2" | 13257-14 |
| 13258-16 | 16 cm, 6 1/4" | 13259-16 |

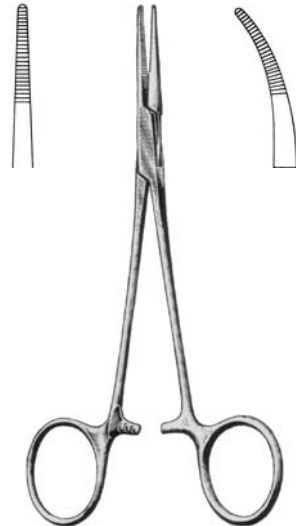

PROVIDENCE-HOSPITAL

- | | | |
|----------|---------------|----------|
| 13270-14 | 14 cm, 5 1/2" | 13271-14 |
|----------|---------------|----------|

Arterienklemmen
 Artery Forceps
 Pinzas hemostáticas
 Pinze emostatiche

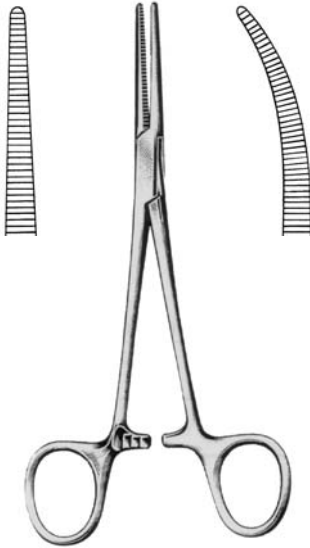

CRILE
 13250-14 14 cm, 5½" 13251-14
 13250-18 18 cm, 7" 13251-18
 13254-14 14 cm, 5½" 13255-14

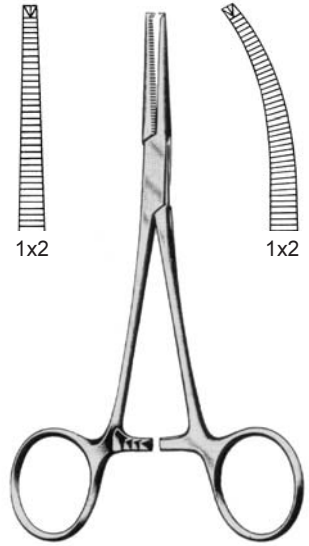

CRILE
 13260-14 14 cm, 5½" 13261-14

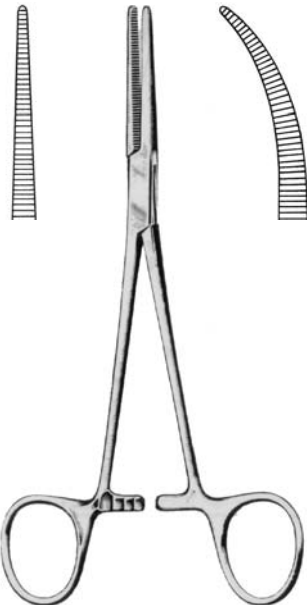

CRILE-RANKIN
 13262-16 16 cm, 6¼" 13263-16

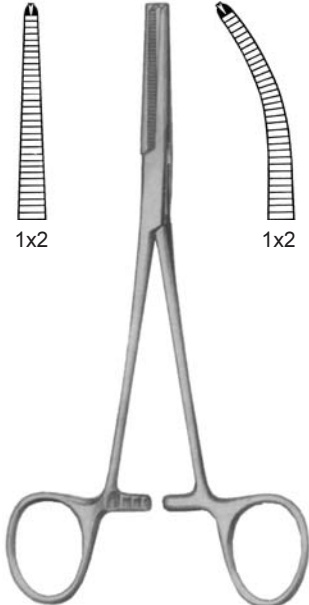

CRILE-RANKIN
 13264-16 16 cm, 6¼" 13265-16

Arterienklemmen
 Artery Forceps
 Pinzas hemostáticas
 Pinze emostatiche

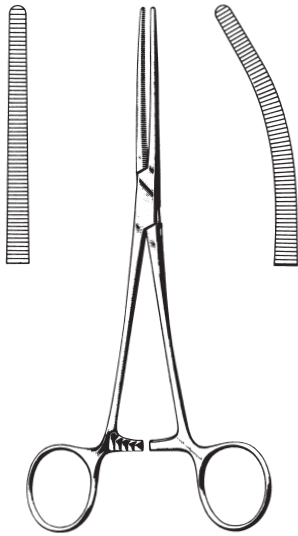

ROCHESTER-PEAN

- | | | |
|----------|--|----------|
| 13310-13 | 13,0 cm, 5 ¹ / ₈ " | 13311-13 |
| 13310-14 | 14,0 cm, 5 ¹ / ₂ " | 13311-14 |
| 13310-16 | 16,0 cm, 6 ¹ / ₄ " | 13311-16 |

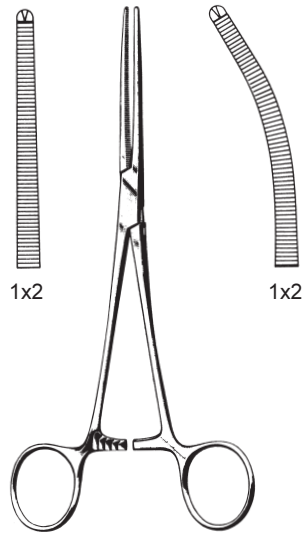

ROCHESTER-OGHSNER

- | | | |
|----------|--|----------|
| 13320-13 | 13,0 cm, 5 ¹ / ₈ " | 13321-13 |
| 13320-14 | 14,0 cm, 5 ¹ / ₂ " | 13321-14 |
| 13320-16 | 16,0 cm, 6 ¹ / ₄ " | 13321-16 |

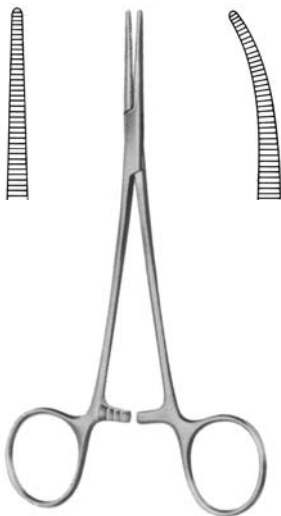

LERICHE

- | | | |
|----------|-----------|----------|
| 13380-15 | 15 cm, 6" | 13381-15 |
|----------|-----------|----------|

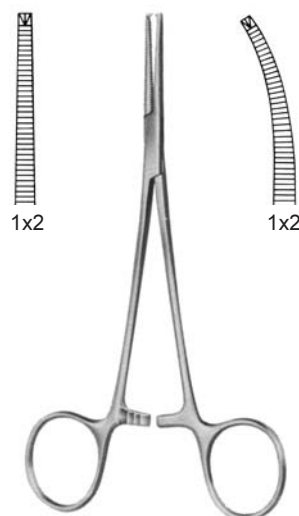

LERICHE

- | | | |
|----------|-----------|----------|
| 13382-15 | 15 cm, 6" | 13383-15 |
|----------|-----------|----------|

Arterienklemmen
Artery Forceps
Pinzas hemostáticas
Pinze emostatiche

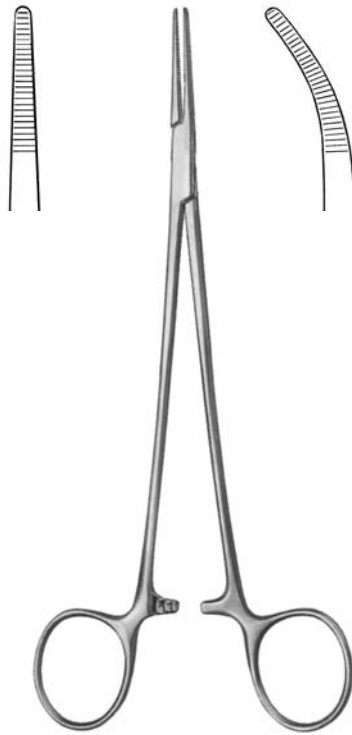

ADSON
13410-18 18,5 cm, 7¹/₄" 13411-18

Wundhaken
Retractors
Separadores
Divaricatori

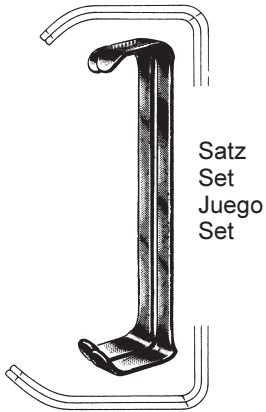

FARABEUFF
19102-12
12 cm, 4³/₄"

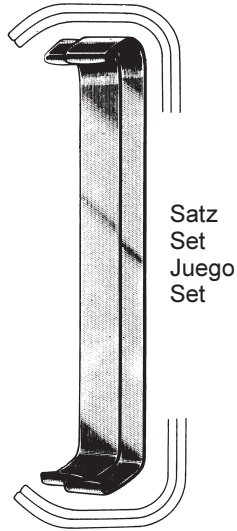

FARABEUFF
19102-15
15 cm, 6"

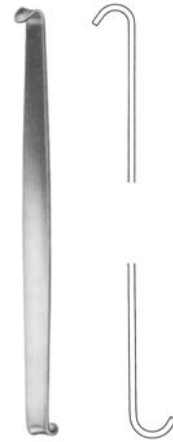

ROUX mini
19124-15
14 cm, 5¹/₂"



RAGNELL
19125-14
14 cm, 5¹/₂"

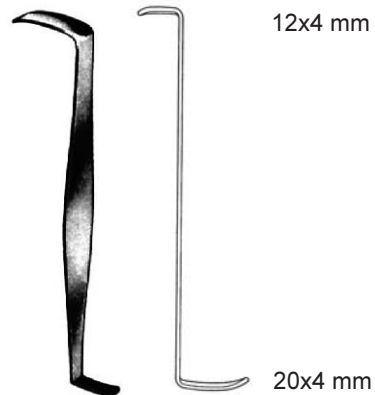

CRILE
19127-11
13 cm, 5¹/₈"

Bauch- und Darmspatel, biegsam
Abdominal and Intestinal Spatulas, malleable
Espátulas abdominales e intestinales, maleables
Spatole addominali e intestinali, malleabili



RIBBON

19168-06	6x200 mm
19168-08	8x200 mm
19168-10	10x200 mm
19168-12	12x200 mm
19168-17	17x200 mm
19168-20	20x200 mm
19168-25	25x200 mm
19169-25	25x250 mm



RIBBON

19170-20	20x330 mm
19170-25	25x330 mm
19170-32	32x330 mm
19170-40	40x330 mm
19170-45	45x330 mm
19170-50	50x330 mm
19170-65	65x330 mm
19170-76	76x330 mm

Wundhaken
Retractors
Separadores
Divaricatori

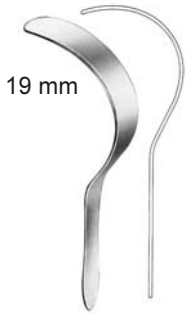

19 mm

DEAVER
19180-19
19 cm, 7½"



22 mm

DEAVER
19181-22
21,5 cm, 8½"

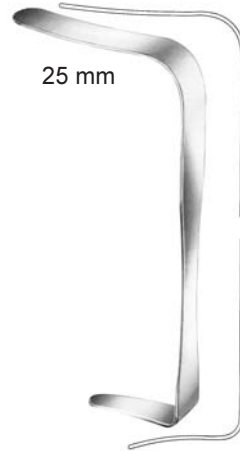

25 mm

DEAVER
19181-25
23 cm, 9"



25 mm

DEAVER
19183-25
30 cm, 11¾"



25 mm

DEAVER
19185-25
33 cm, 13"



25 mm

DEAVER
19187-25
36 cm, 14"

Wundhaken
Retractors
Separadores
Divaricatori



FREEMAN
19188-12
20 cm, 8°, 12 mm wide



mit Kaltlicht + Absaugung
with cold light + aspiration
con luz fria + aspiración
con luce fredda + aspirazione

FREEMAN
19188-12CL
20 cm, 8°, 12 mm wide

Feine Wundhaken
Retractors
Separadores
Divaricatori



GRAEFE
19210-12

scharf
sharp
agudo
acuto



GRAEFE
19211-12

stumpf
blunt
romo
smusso



12 cm, 4³/₄"



GUTHRIE
19212-01

scharf
sharp
agudo
acuto



GUTHRIE
19212-02



TYRELL
19213-12
12 cm, 4³/₄"

scharf
sharp
agudo
acuto

Feine Wundhaken
Retractors
Separadores
Divaricatori



FRAZIER

A	scharf	B	stumpf
	sharp		blunt
	agudo		romo
	acuto		smusso

A	19214-13	13 cm, 5 ¹ / ₈ "
A	19214-18	18 cm, 7"
B	19215-13	13 cm, 5 ¹ / ₈ "
B	19215-18	18 cm, 7"



LAHEY
12 cm, 4³/₄"



19215-01



19215-02



19215-03



JOSEPH
16 cm, 6¹/₄"



19216-01
1 mm



19216-02
2 mm



19216-05
5 mm



19216-07
7 mm



19216-10
10 mm



KLEINERT-KUTZ
13 cm, 5¹/₈"



19217-03



19217-05



19217-07

Feine Wundhaken
Retractors
Separadores
Divaricatori



BARSKY
19218-01
15 cm, 6"



BARSKY
19218-02
15 cm, 6"



HUMBY
19218-11
11,5 cm, 4 1/2"

Wundhaken
Retractors
Separadores
Divaricatori

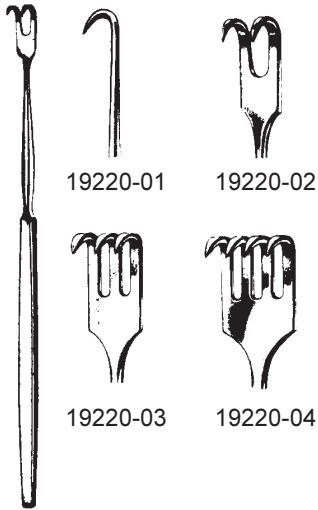

19220-01

19220-02

19220-03

19220-04

Reda
16 cm, 6 1/4"

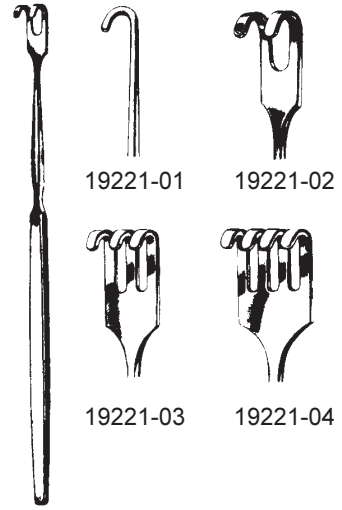

19221-01

19221-02

19221-03

19221-04

Reda
16 cm, 6 1/4"

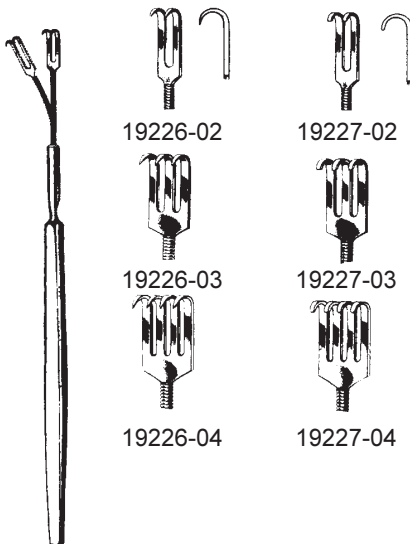

19226-02

19227-02

19226-03

19227-03

19226-04

19227-04

Reda, flexibel
16 cm, 6 1/4"



19229-02

19229-03

KLAPP
17,5 cm, 6.9"

Wundhaken
Retractors
Separadores
Divaricatori



DESMARRES
19230-00 16 cm, 6 1/4"



19230-10 10 mm



19230-16 16 mm



19230-12 12 mm



19230-18 18 mm



19230-14 14 mm



DESMARRES
19234-00 14 cm, 5 1/2"

8 mm

10 mm



KASDAN
19237-16 16 cm, 6 1/4"



VOLKMANN
11,5 cm, 4 1/2"



19270-02

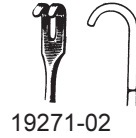

19271-02



19270-03



19271-03



19270-04



19271-04



19270-06



19271-06

Wundhaken
Retractors
Separadores
Divaricatori



MEYERDING
18 cm, 7"



19302-01 18x7 mm



19302-04 7x4 mm



19302-02 16x5 mm



19302-05 10x3 mm



19302-03 7x4 mm



19302-06 10x4 mm



STRANDELL-STILLE
17 cm, 6³/₄"



19307-01



19307-02

Wundsperrer
Retractors
Separadores
Divaricatori

3x4



spitz
sharp
agudo
acuto

stumpf
blunt
romo
smusso

FINSSEN

19610-07 7 cm, 2³/₄" 19611-07

4x4



spitz
sharp
agudo
acuto

stumpf
blunt
romo
smusso

ALM

19620-07 7 cm, 2³/₄" 19621-07
19620-10 10 cm, 4" 19621-10

3x3



spitz
sharp
agudo
acuto

stumpf
blunt
romo
smusso

JANSEN

19630-10 10 cm, 4" 19631-10

4x4



spitz
sharp
agudo
acuto

stumpf
blunt
romo
smusso

HOLZHEIMER

19634-10 10 cm, 4" 19635-10

Wundsperrer
Retractors
Separadores
Divaricatori

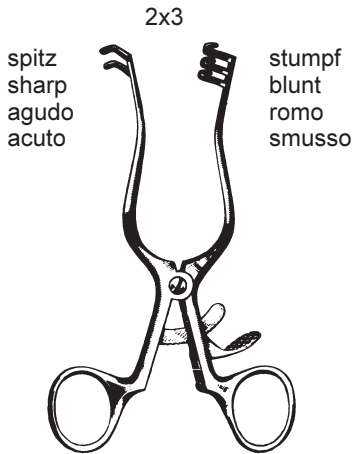

WEITLANER
19650-10 11,5 cm, 4 1/2" 19651-10

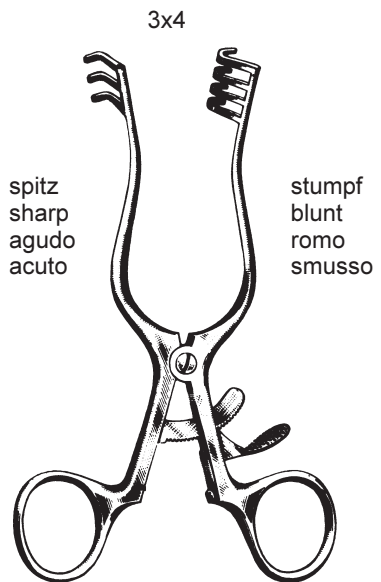

WEITLANER
19670-14 14 cm, 5 1/2" 19671-14

Endo Dissektoren
Endo dissectors
Disectores
Dissettori



24 cm, 9 1/2"



19741-01 LANGENBECK, 5,0 mm
19741-02 LANGENBECK, 7,0 mm
19741-03 LANGENBECK, 10,0 mm



19741-04 LANGENBECK, 5,0 mm
19741-05 LANGENBECK, 7,0 mm
19741-06 LANGENBECK, 10,0 mm



19741-07 LANGENBECK, 12,5 mm



19741-08 LANGENBECK-COTTLE 7,0 mm



19741-09 LANGENBECK-COTTLE, 7,0 mm



19741-10 LANGENBECK
konkav, concave, concavo, concavo



19741-11 Mini-LANGENBECK



Nervenhaken / nerve hook
gancho para nervios / uncino p. nervi

19741-12 links / left / izquierda / sinistra
19741-13 rechts / right / derecha / destra

Wundhaken für plastische Chirurgie
Retractors for plastic surgery
Separadores para cirugía plástica
Divaricatore per chirurgia plastica



FERRIERA

19960-01	80 mm x 16 mm
19960-02	100 mm x 25 mm
19960-03	120 mm x 25 mm
19960-04	120 mm x 30 mm
19960-05	150 mm x 25 mm
19960-06	150 mm x 30 mm



mit Kaltlicht + Absaugung
with cold light + aspiration
con luz fria + aspiracion
con luce fredda + aspirazione

TEBBETTS

19980-01	80 mm x 16 mm
19980-02	100 mm x 25 mm
19980-03	120 mm x 25 mm
19980-04	120 mm x 30 mm
19980-05	150 mm x 25 mm
19980-06	150 mm x 30 mm

Wundhaken für plastische Chirurgie
 Retractors for plastic surgery
 Separadores para cirugía plástica
 Divaricatore per chirurgia plastica



BREAST
 19970-01 26 cm, 10 1/4"



CORONAL
 19980-18 18 cm, 7"



YANKOSKIE
 19990-18 18 cm, 7"



YANKOSKIE
 19991-18
 23 cm, 9", 150 mm wide



FREEMAN
 19995-22
 18 cm, 7", 22 mm
 19995-38
 18 cm, 7", 38 mm wide

3 Finger
 3 prongs
 3 dientes
 3 rebbi



5 Finger
 5 prongs
 5 dientes
 5 rebbi

ANDERSON
 19998-03 12 cm, 4 3/4" 19998-05

Spatel
Spatula
Espatula
Spatola



biegsam
malleable
maleable
malleabile

2,5 x 15 cm
1" x 6"

19992-31
31,5 cm, 12 1/2"

Wundhaken für plastische Chirurgie
Retractors for plastic surgery
Separadores para cirugía plástica
Divaricatore per chirurgia plastica



GORNEY
19996-04
7,5 cm, 3", 38 mm



FREEMAN
19997-09
9 cm, 3 1/2", 20 mm

Brustdissektoren
Breast Dissectors
Separadores mamarios
Separatori mammari



Satz
Set
Juego
Set

AGRIS-DINGMAN
19999-00 36 cm, 14"

Brustdissektoren
Breast Dissectors
Separadores mamarios
Separatori mammari



MacCOLLUM-DINGMAN
19999-01
41 cm, 16"



TEBBETTS
19999-02
33 cm, 13"



TEBBETTS
19999-03
33 cm, 13"



SILVERSTEIN
19999-04
35,6 cm, 14"

Wundhaken für plastische Chirurgie
Retractors for plastic surgery
Separadores para cirugía plástica
Divaricatore per chirurgia plastica



BIGGS

19999-30	30 mm
19999-50	50 mm

19999-30 CL	30 mm
19999-50 CL	50 mm

CL = mit Kaltlicht + Absaugung
with cold light + aspiration
con luz fria + aspiracion
con luce fredda + aspirazione

Nervenhaken, Durahaken
Nerve Hooks, Dura Hooks
Ganchos para nervios y para duramadre
Unicini per nervi e per dura-madre



CRILE
41054-20
20 cm, 8"

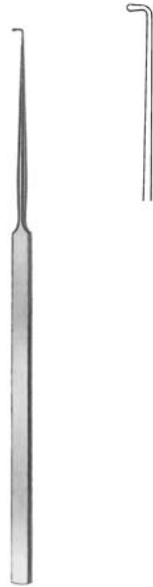

CUSHING
41056-18
18 cm, 7"



CUSHING
41058-18
18 cm, 7"



scharf
sharp
agudo
acuto

ADSON
41068-20
20 cm, 8"



stumpf
blunt
rombo
smusso

ADSON
41069-20
20 cm, 8"

Feine Wundhaken
Retractors
Separadores
Divaricatori



spitz
sharp
agudo
acuti

O'CONNOR
43370-12
12 cm, 4³/₄"



spitz
sharp
agudo
acuti

WIENER
43372-13
13 cm, 5¹/₈"



stumpf
blunt
romo
smussi

WIENER
43373-13
13 cm, 5¹/₈"



spitz
sharp
agudo
acuti

ROLLET
43376-13
13,5 cm, 5¹/₄"

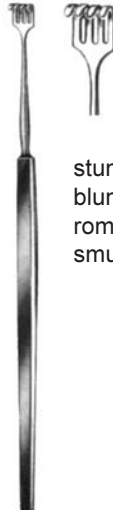

stumpf
blunt
romo
smussi

KNAPP
43377-13
13 cm, 5¹/₈"

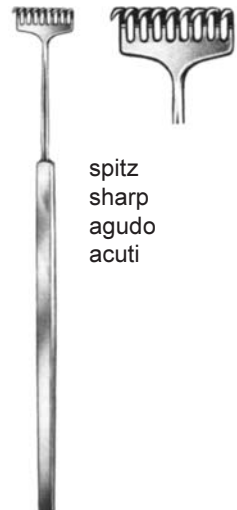

spitz
sharp
agudo
acuti

MILLER
43378-13
13 cm, 5¹/₈"

Nasenhaken
 Nasal retractors
 Separadores nasales
 Retrattori nasali



CONVERSE

- 47538-01 9 cm, 3 1/2" 18 x 9,5 mm
- 47538-02 9 cm, 3 1/2" 28 x 12,5 mm
- 47538-03 9 cm, 3 1/2" 41 x 13,5 mm
- 47538-04 9 cm, 3 1/2" 53 x 13,5 mm



COTTLE

- 47540-16
 16 cm, 6 1/4"



MALINIAC

- 47550-11
 11 cm, 4 3/8"

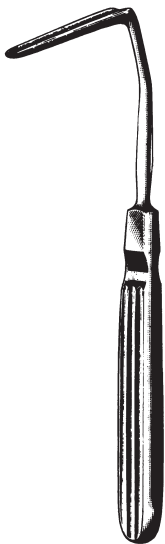

AUFRICHT

- 47551-16
 16 cm, 6 1/4"



AUFRICHT

- 47551-16L
 16 cm, 6 1/4"



MASING-NEIVERT

- 47552-16
 16 cm, 6 1/4"



COTTLE

- 47553-15
 15 cm, 6"

10 x 12 mm

Hauthäkchen, Nasenhaken
 Skin hook, Nasal retractors
 Gancho para piel, Separadores nasales
 Uncino per pelle, Retrattori nasali



47554-01



47554-02



47554-03

COTTLE
 14,5 cm, 5³/₄"

3 x 11 mm



KILNER
 47555-08 8 cm, 3¹/₈"

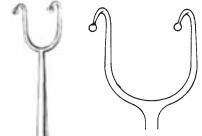

FOMON
 47556-16 16 cm, 6¹/₄"



FOMON
 47557-17 17 cm, 6³/₄"



FREER
 47558-15 15 cm, 6"



COTTLE-NEIVERT
 47559-20 20 cm, 8"

Feine Wundhaken
Retractors
Separadores
Divaricatori

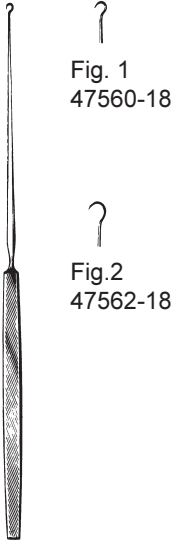

Fig. 1
47560-18

Fig. 2
47562-18

GILLIES
18 cm, 7"



LANGE
47563-22 23 cm, 9"



COTTLE
47564-16 16 cm, 6 1/4"



CONVERSE
47566-12 12 cm, 4 3/4"



MARTINEZ-KILNER
47567-11 11 cm, 4 3/8"

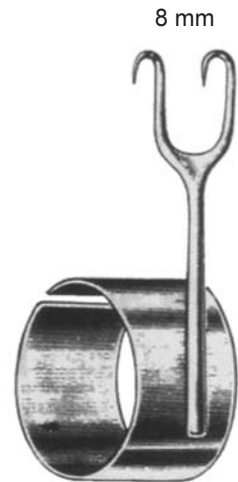

COTTLE
47568-08

Trachealhaken
Trachea Hooks
Ganchos para traqueotomía
Ganci per tracheotomia



JACKSON
55116-15
15 cm, 6"



JACKSON
55117-17
17 cm, 6³/₄"



NEWS
55120-15
15 cm, 6"

Nadelhalter
Needle Holders
Porta-agujas
Portaghi



DERF
25110-12 12 cm, 4³/₄" 25114-12 TC



WEBSTER
25128-13 13 cm, 5¹/₈"
25129-13 TC 13 cm, 5¹/₈"



HALSEY
25130-13 13 cm, 5¹/₈" 25140-13
25134-13 TC 13 cm, 5¹/₈" 25144-13 TC

Nadelhalter
Needle Holders
Porta-agujas
Portaghi



BAUMGARTNER

- | | | |
|----------|--------------|-------------|
| 25150-12 | 12,5 cm, 5" | 25154-12 TC |
| 25150-14 | 14,0 cm, 5½" | 25154-14 TC |



CRILE-WOOD

- | | | |
|----------|-----------|-------------|
| 25160-15 | 15 cm, 6" | 25164-15 TC |
| 25160-18 | 18 cm, 7" | 25164-18 TC |
| | 20 cm, 8" | 25164-20 TC |
| | 23 cm, 9" | 25164-23 TC |



MAYO-HEGAR

- | | | |
|----------|------------|-------------|
| 25180-12 | 12 cm, 4¾" | 25184-12 TC |
| 25180-14 | 14 cm, 5½" | 25184-14 TC |
| 25180-16 | 16 cm, 6¼" | 25184-16 TC |
| 25180-18 | 18 cm, 7" | 25184-18 TC |
| 25180-20 | 20 cm, 8" | 25184-20 TC |



DeBAKEY

- | | |
|-------------|------------|
| 25214-16 TC | 16 cm, 6¼" |
| 25214-18 TC | 18 cm, 7" |
| 25214-20 TC | 20 cm, 8" |
| 25214-23 TC | 23 cm, 9" |

Nadelhalter
Needle Holder
Porta-agujas
Portaghi

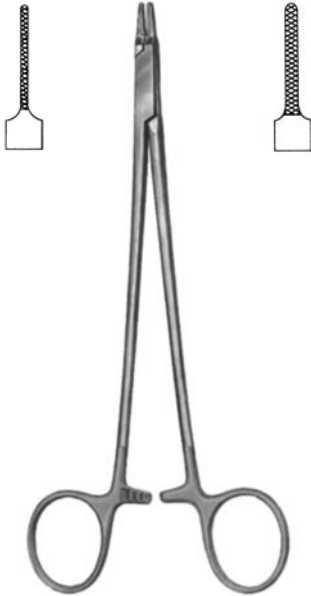

1 mm RYDER 2 mm

25224-13TC	13 cm, 5 ¹ / ₈ "	25225-13 TC
25224-15TC	15 cm, 6"	25225-15 TC
25224-16TC	16 cm, 6 ¹ / ₄ "	25225-16 TC
25224-18TC	18 cm, 7"	25225-18 TC
25224-20TC	20 cm, 8"	25225-20 TC

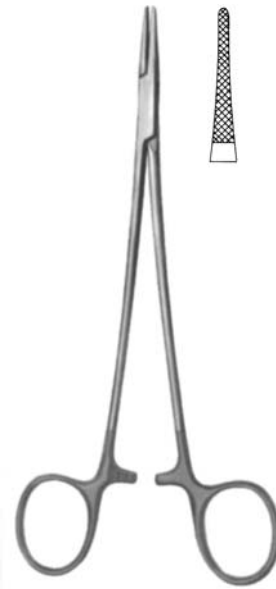

MICROVASCULAR

25230-18TC	18 cm, 7"
25230-20TC	20 cm, 8"



BABY OLSEN-HEGAR

25405-12	12 cm, 4 ³ / ₄ "	25406-12
25408-12TC	12 cm, 4 ³ / ₄ "	25407-12TC

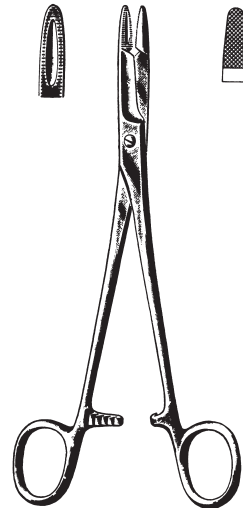

OLSEN-HEGAR

25410-14	14 cm, 5 ¹ / ₂ "	25414-14TC
25410-17	17 cm, 6 ³ / ₄ "	25414-17TC
	18 cm, 7"	25414-18TC

Nadelhalter
Needle Holders
Porta-agujas
Portaghi



GILLIES

25434-11TC	11 cm, 4 ³ / ₈ "
25434-13TC	13 cm, 5 ¹ / ₈ "
25434-16TC	16 cm, 6 ¹ / ₄ "

Mikro-Nadelhalter
Micro Needle Holders
Micro-porta-agujas
Micro portaghi

ohne Sperre
without lock
sin cremallera
senza cremagliera

mit Sperre
with lock
con cremallera
con cremagliera



11,5 cm, 4 1/2"
13,0 cm, 5 1/8"
14,0 cm, 5 1/2"
18,0 cm, 7"
21,0 cm, 8 1/4"
23,0 cm, 9"

25660-12
25660-13
25660-14
25700-18

25661-12
25661-13
25661-14
25701-18

25720-12
25720-13
25720-14
25730-18
25730-21
25730-23

25731-12
25731-13
25731-14
25731-18
25731-21
25731-23

mit diamantiertem Maul
with diamond jaw
con boca de diamante
con morso diamantato

11,5 cm, 4 1/2"
13,0 cm, 5 1/8"
14,0 cm, 5 1/2"
18,0 cm, 7"
21,0 cm, 8 1/4"
23,0 cm, 9"

25720-12D
25720-13D
25720-14D
25730-18D
25730-21D
25730-23D

25671-12D
25671-13D
25671-14D
25731-18D
25731-21D
25731-23D

T= Titan, titanium, titanio, titanio



15,0 cm, 6"
18,0 cm, 7"
21,0 cm, 8 1/4"

93250-15T
93250-18T
93250-21T

93251-15T
93251-18T
93251-21T

93260-15T
93260-18T
93260-21T

93261-15T
93261-18T
93261-21T



BARRAQUER

Mikro-Nadelhalter mit Sperre
 Micro Needle Holders, with lock
 Micro-porta-agujas con cremallera
 Micro portaghi, con cremagliera

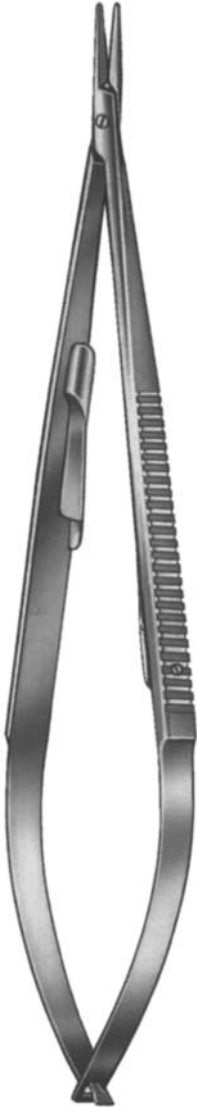

14,0 cm, 5 1/2"
 18,0 cm, 7"
 21,5 cm, 8 1/2"
 23,0 cm, 9"



25670-14
 25670-18
 25670-21



25671-14
 25671-18



25672-14
 25672-18
 25672-21
 25672-23



25673-14
 25673-18

mit TC 1,4 mm
 with TC jaw 1,4 mm
 con TC 1,4 mm
 con morso in TC 1,4 mm

14,0 cm, 5 1/2"
 18,0 cm, 7"
 21,5 cm, 8 1/2"
 23,0 cm, 9"

25674-14	25675-14	25676-14	25677-14
25674-18	25675-18	25668-18	25691-18
25674-21		25668-21	
		25668-23	

mit diamantiertem Maul 0,8 mm
 with diamond jaw 0,8 mm
 con boca de diamante 0,8 mm
 con morso diamantato 0,8 mm

14,0 cm, 5 1/2"
 18,0 cm, 7"
 21,5 cm, 8 1/2"
 23,0 cm, 9"

25672-14D	25673-14D
25672-18D	25673-18D
25672-21D	
25672-23D	

T= Titan, titanium, titanio, titanio
 Maul/jaw/boca/morso 0,4mm

14,0 cm, 5 1/2"
 18,0 cm, 7"
 21,5 cm, 8 1/2"

25672-14T	25673-14T
25672-18T	25673-18T
25672-21T	25673-21T

CASTROVIEJO

Drahtzangen
Wire Twisting Forceps
Pinza para torcer hilos
Pinza torcifili



MAYO-HABERISSER TC



34554-15 TC 15 cm, 6" 34555-15 TC



34554-18 TC 18 cm, 7" 34555-18 TC



34554-20 TC 20 cm, 8" 34555-20 TC



BERRY TC

34556-18TC 18 cm, 7"

Hohlmeißelzange
 Bone Rongeurs
 Pinzas-gubias
 Pinze sgorbie

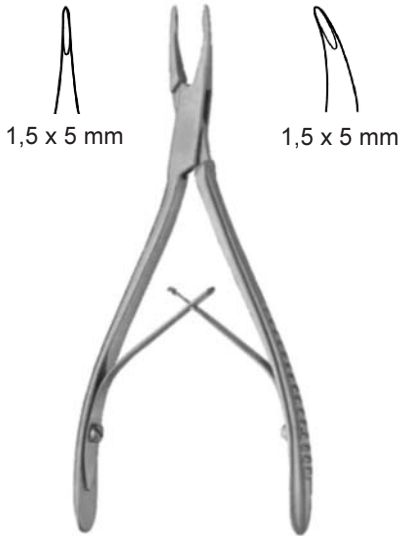

MICRO FRIEDMANN
 33100-01 14,5 cm, 5³/₄" 33100-02

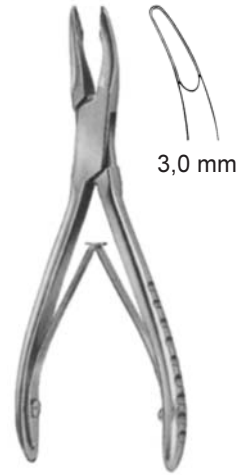

FRIEDMANN MINI
 33101-12 12 cm, 4³/₄"

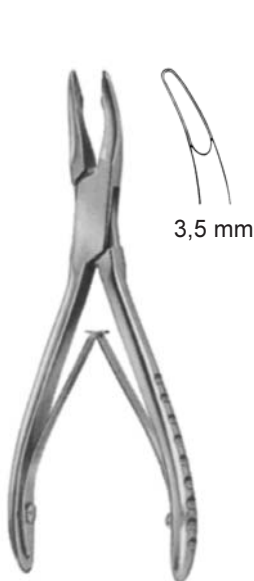

FRIEDMANN
 33101-14 14 cm, 5¹/₂"



BEYER
 33201-18 18 cm, 7"

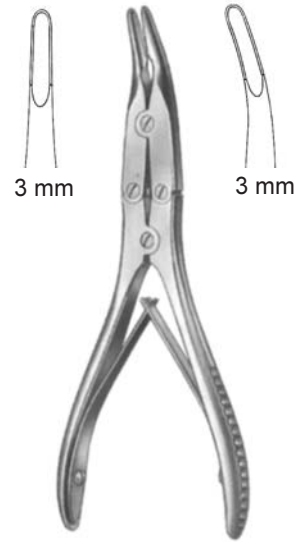

BÖHLER
 33211-15 15 cm, 6" 33213-15

Knochensplitterzangen
Bone Cutting Forceps
Pinzas cortantes para huesos
Cesoie per ossa



BÖHLER
33280-15 15 cm, 6"



BÖHLER
33281-15 15 cm, 6"



COTTLE-KAZANJIAN
33282-19 19 cm, 7¹/₂"



MC INDOE
33283-17 17 cm, 6³/₄"

Hämmer
Bone Mallets
Martillos
Martelli

Ø 25 mm



GERZOG
33686-25
18 cm, 7" 250g

Ø 25 mm



33694-01 18,5 cm, 7 1/4", 135 g
33694-03 Ersatzbacken
Nylon Caps
Tapas de repuesto
Placche di ricambio

Ø 25 mm



33694-02 18,5 cm, 7 1/4"
mit Nylonbacke
with nylon tap
con tapa de nylon
con placca di nylon

Ø 20 mm



MEAD
33693-32
17 cm, 6 3/4" 320 g

Ø 22 mm



PARTSCH
33698-98
18 cm, 7" 199 g



QUISLING
33696-75
17 cm, 6 3/4"

Ø 30 mm



COTTLE
33700-05
18 cm, 7" 240 g

Elevatoren, Raspatoren
Elevators, Raspatories
Elevadores, Legras
Elevatori, Periostotomi



LANGENBECK
20 cm, 8"
33711-20 8 mm
33711-21 10 mm



4 mm

WILLIGER
16 cm, 6¹/₄"
33711-16



6,5 mm

WILLIGER
16 cm, 6¹/₄"
33712-16



5,5 mm

WILLIGER
33713-17
16 cm, 6¹/₄"



4 mm

JOSEPH
33718-16
16 cm, 6¹/₄"



4 mm

FOMON
33719-17
16 cm, 6¹/₄"

Elevatoren, Raspatoren
 Elevators, Raspatories
 Elevadores, Legras
 Elevatori, Periostotomi

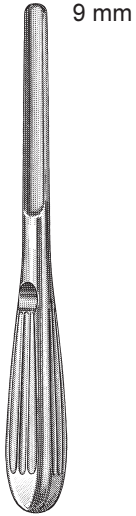

BOIES
 33720-19
 19 cm, 7 1/2"



GORNEY
 33720-21
 21 cm, 8 1/4"



4 mm
 47410-04



5 mm
McKENTY
 15 cm, 6"

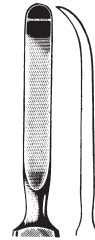

47410-05



JOSEPH
 47411-16
 16 cm, 6 1/4"



MASING
 47414-21
 22 cm, 8 3/4"



FREER
 47415-18
 18 cm, 7"

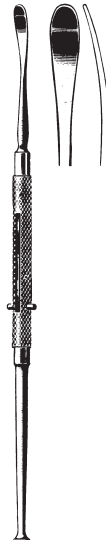

FREER
 47417-19
 19 cm, 7 1/2"

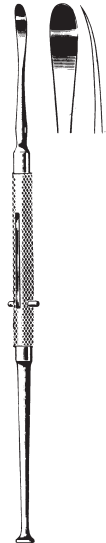

FREER
 47419-19
 19 cm, 7 1/2"

Elevatoren, Raspatoren
Elevators, Raspatories
Elevadores, Legras
Elevatori, Periostotomi



KILLIAN
47420-01
18,5 cm, 7¹/₄"



PIERCE
47420-02
21 cm, 8¹/₄"

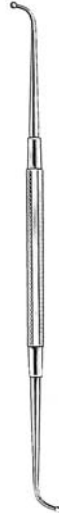

SINUS
47420-03
18 cm, 7"



PENNINGTON
47420-04
21 cm, 8¹/₄"



McKENTY
47420-20
22 cm, 8³/₄"



HOWARTH
47421-21
21,5 cm, 8¹/₂"

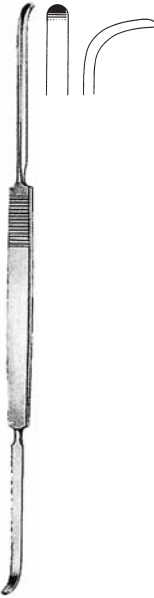

COTTLE
47421-23
23 cm, 9"



COTTLE JOSEPH
47422-22
22 cm, 8³/₄"

Elevatoren, Raspatoren
 Elevators, Raspatories
 Elevadores, Legras
 Elevatori, Periostotomi



COTTLE
 47423-22 22 cm, 8³/₄"

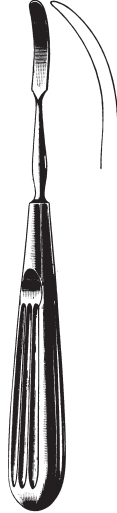

COTTLE
 47424-16 16 cm, 6¹/₄"



COTTLE
 47425-19 19 cm, 7¹/₂"

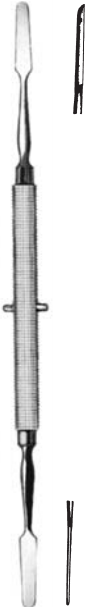

KILLIAN
 47426-22 22 cm, 8³/₄"



HAJEK-BALLENGER
 47428-21 22 cm, 8³/₄"



BALLENGER
 47430-22 22 cm, 8³/₄"

Lippen- und Gaumenspaltinstrumente
Lip and Cleft Palate Instruments
Instrumentos para labios y fisura palatina
Strumenti per labbra e fessure del palato

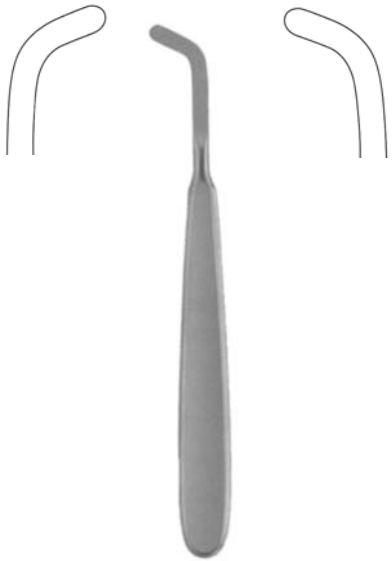

49278-01 14 cm, 5 1/2" 49278-02



CRIONIN
49280-18 18 cm, 7"

Lippen- und Gaumenspaltinstrumente
Lip and Cleft Palate Instruments
Instrumentos para labios y fisura palatina
Strumenti per labbra e fessure del palato



BLAIR
49281-01
23 cm , 9"



BLAIR
49281-02
20 cm, 8"

Saugkanülen
Suction Tubes
Tubos de aspiracion
Cannula aspirante



ADSON
41290-21
20 cm, 8 1/4"
Ø 4 mm



Arbeitslänge
working length
largo útil
lunghezza utile
75 mm

BARON
41299-03 3FR Ø 1,0 mm
41299-05 5FR Ø 1,6 mm
41299-07 7FR Ø 2,3 mm

Saugkanülen
Suction Tubes
Tubos de aspiracion
Cannula aspirante



FRAZIER/FERGUSSON
19 cm, 7 1/2"

Charr.

F.G.	Ø	30°	75°
6	2,0 mm	41295-06	41297-06
7	2,3 mm	41295-07	41297-07
8	2,7 mm	41295-08	41297-08
9	3,0 mm	41295-09	41297-09
10	3,3 mm	41295-10	41297-10
11	3,6 mm	41295-11	41297-11
12	4,0 mm	41295-12	41297-12

Saugkanülen
Suction Tubes
Tubos de aspiracion
Cannula aspirante

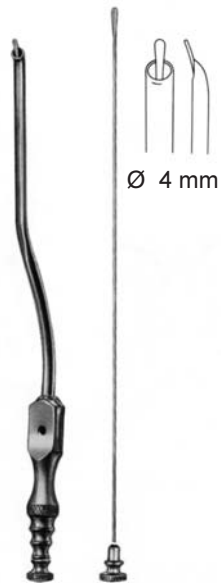

GULEN
47347-20
19 cm, 7¹/₂"
Ø 4 mm

Nasenspekula
Nasal Speculum
Espéculos nasales
Specoli nasali



HARTMANN-HALLE
15 cm, 6"

28 mm

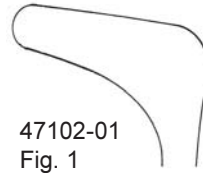

47102-01
Fig. 1

30 mm

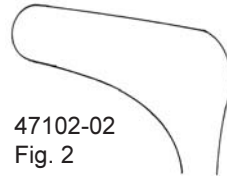

47102-02
Fig. 2

32 mm

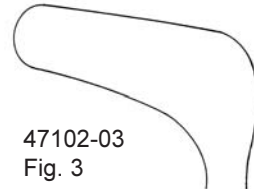

47102-03
Fig. 3

Nasenspekula
Nasal Speculum
Espéculos nasales
Specoli nasali



HARTMANN
16 cm, 6 1/4"

30 mm

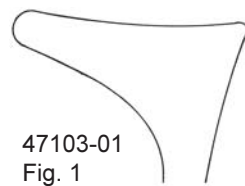

47103-01
Fig. 1

33 mm

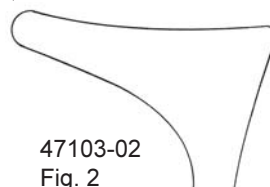

47103-02
Fig. 2

35 mm

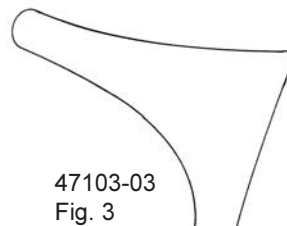

47103-03
Fig. 3

Nasenspekula
 Nasal Speculum
 Espéculos nasales
 Specoli nasali



Mod. WIEN
 14 cm, 5 1/2"

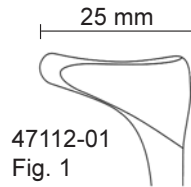

Baby, bebé, neonato

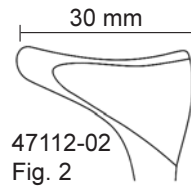

Kind, child, niño, bambino

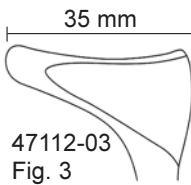

Erwachsene, Adult, adulto



TIECK-HALLE
 47116-13
 13,5 cm, 5 1/4"



REDA
 47118-13
 12,5 cm, 5"

Nasenspekula
Nasal Specula
Espéculos nasales
Specoli nasali



KILLIAN
13 cm, 5¹/₈"

35 mm

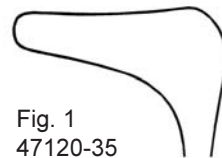

Fig. 1
47120-35

50 mm



Fig. 2
47120-50

75 mm



Fig. 3
47120-75

90 mm

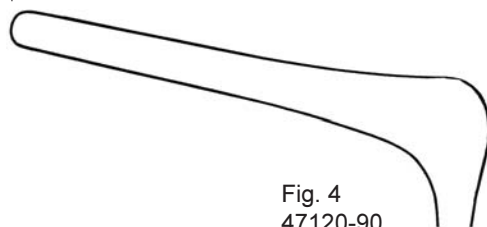

Fig. 4
47120-90

Nasenspekula
Nasal Specula
Espéculos nasales
Specoli nasali



KILLIAN
13 cm, 5¹/₈"

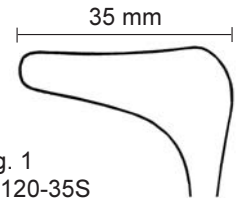

Fig. 1
47120-35S

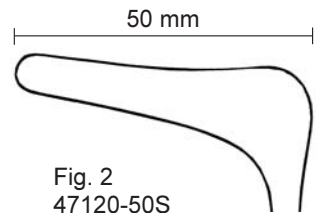

Fig. 2
47120-50S

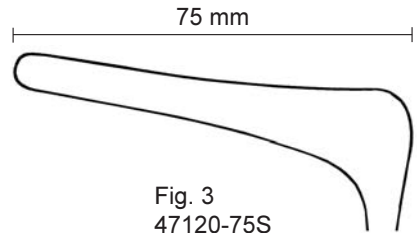

Fig. 3
47120-75S

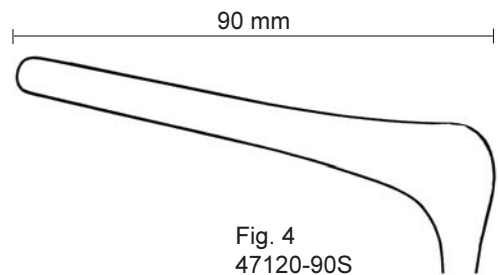

Fig. 4
47120-90S

Nasenspekula
Nasal Speculum
Espéculos nasales
Specoli nasali



COTTLE
14 cm, 5½"

35 mm

Fig. 1
47124-35

50 mm

Fig. 2
47124-50

75 mm

Fig. 3
47124-75

90 mm

Fig. 4
47124-90

Nasenspekula
Nasal Speculum
Espéculos nasales
Specoli nasali



COTTLE
14 cm, 5 1/2"

35 mm

Fig. 1
47124-35S

50 mm

Fig. 2
47124-50S

75 mm

Fig. 3
47124-75S

90 mm

Fig. 4
47124-90S

Nasentamponzange, Polypenzange
Nasal Tampon Forceps, Ear Polypus Forceps
Pinza para taponamiento, Pinzas para pólipos
Pinze per medicature, Pinze per polipi



WESTMACOTT
47158-20 20 cm, 8"



LUBET-BARBON
47159-20 20 cm, 8"



HARTMANN
47161-16 16 cm, 6 1/4"



HARTMANN
47161-20 20 cm, 8"

Polypenzangen, Septumzangen
Nasal Polypus and Septum Forceps
Pinzas para pólipos y para el tabique nasal
Pinze per polipi, Pinze per il setto nasale



HEYMANN-KNIGHT
47169-18
18 cm, 7"



KNIGHT
47185-18
18 cm, 7"

Septumzangen
Septum Forceps
Pinzas para el tabique nasal
Pinze per il setto nasale



47191-01

47191-02

47191-03

47191-04

BRUENINGS
19 cm, 7½"

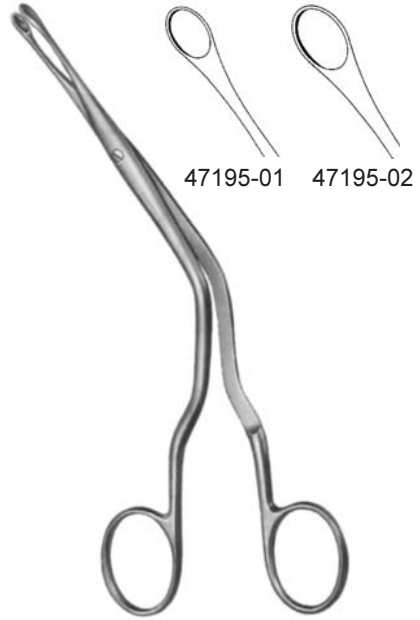

47195-01

47195-02

LUC
19 cm, 7½"



GRAIG
47192-16 16 cm, 6½"

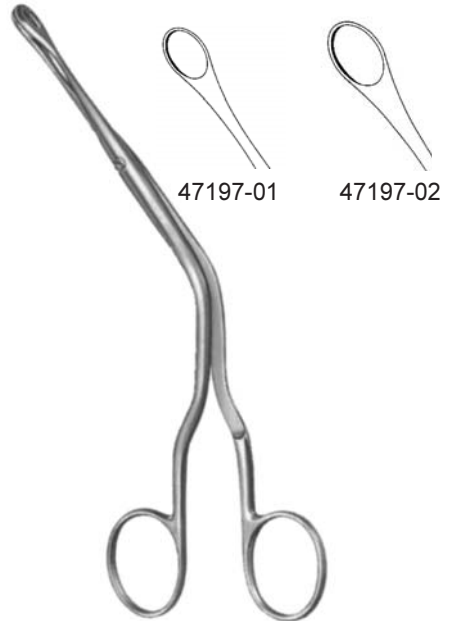









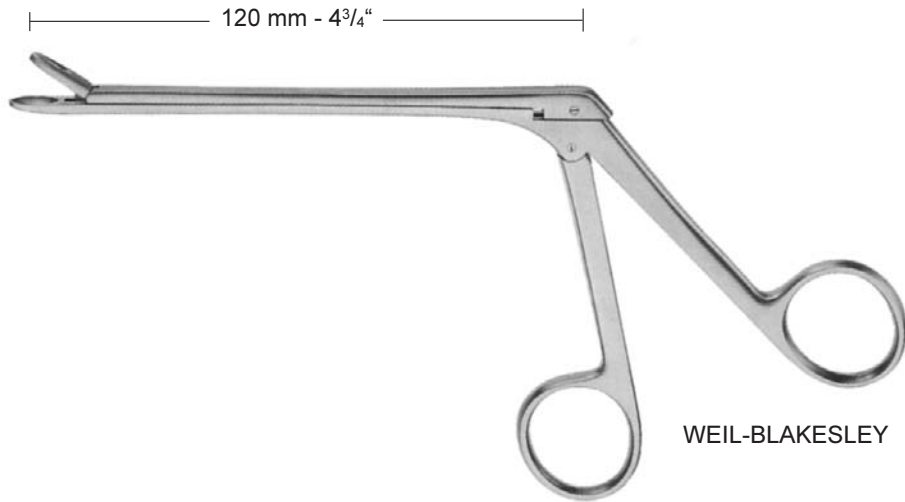

47197-01

47197-02

LUC
19 cm, 7½"

Scharfe Nasenzange
 Nasal Cutting Forceps
 Pinzas cortantes nasales
 Pinze taglianti nasali



					
	Fig. 1	Fig. 2	Fig. 3	Fig. 4	Fig. 5
	47223-01 3,0 mm	47223-02 3,6 mm	47223-03 4,2 mm	47223-04 4,8 mm	47223-05 5,8 mm
	47224-01 3,0 mm	47224-02 3,6 mm	47224-03 4,2 mm	47224-04 4,8 mm	47224-05 5,8 mm
	47225-01 3,0 mm	47225-02 3,6 mm	47225-03 4,2 mm	47225-04 4,8 mm	
	47226-01 2,0 mm	47226-02 2,5 mm	47226-03 3,0 mm		
	47227-01 2,0 mm	47227-02 2,5 mm	47227-03 3,0 mm		

Scharfe Nasenzangen
Nasal Cutting Forceps
Pinzas cortantes nasales
Pinze taglienti nasali

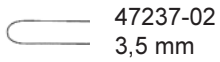
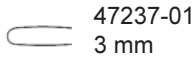

MYLES



SCHMEDEN

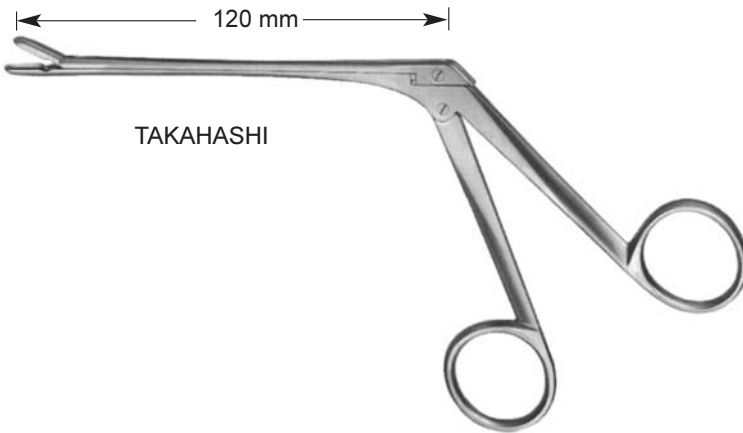

47242-00



47242-01

Septumzange, Scharfe Nasenzange
Septum Forcep, Nasal Cutting Forceps
Pinza para el tabique nasal, Pinza cortante nasal
Pinza per setto nasale, pinze taglianti nasali



RUBIN
47251-21
21 cm, 8 $\frac{1}{4}$ "



CAPLAN
47256-20
20 cm, 8"

Septumzangen
Septum Forceps
Pinzas para el tabique nasal
Pinze per il setto nasale



MIDDLETON-JANSEN
47323-19
19 cm, 7 $\frac{1}{2}$ "



MIDDLETON-JANSEN
47325-19
19 cm, 7 $\frac{1}{2}$ "

Rhinoplastikmesser
Rhinoplasty knives
Cuchillos nasales
bisturi nasale



JOSEPH
16 cm, 6 1/4"

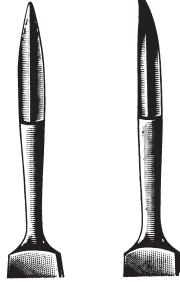

47370-16 47371-16
stumpf, blunt,
romo, smussi

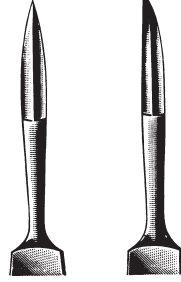

47372-16 47373-16
spitz, pointed,
agudo, acuti



FREER
47374 - 16
16,5 cm, 6 1/2"



JOSEPH
47375 - 16
16 cm, 6 1/4"

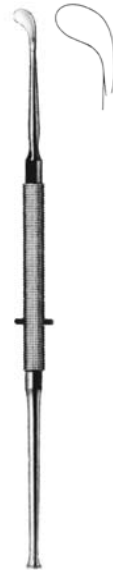

FREER
47375 - 19
19 cm, 7 1/2"

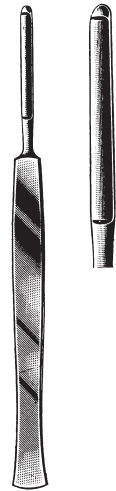

JOSEPH
47376 - 16
16 cm, 6 1/4"

Rhinoplastikmesser
Rhinoplasty knives
Cuchillos nasales
bisturi nasale

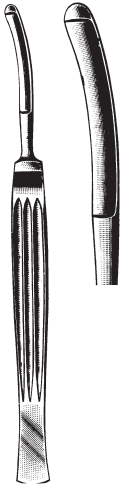

CONVERSE
47379 - 16
16 cm, 6¹/₄"



COTTLE
47380-15
15 cm, 6"



COTTLE
47382-15
15 cm, 6"



JOSEPH
47384-15
15 cm, 6"



JOSEPH
47385-15
15 cm, 6"



REDA
19 cm 7¹/₂"



47386-01
spitz
pointed
agudo
acuto



47386-02
stumpf
blunt
romo
smusso

Schwingmesser
Septum Swivel Knives
Cuchillos para el tabique nasal
Coltelli per setto



BALLENGER
47390-03 - 47392-05
20 cm, 8"



47390-03
3 mm



47390-04
4 mm



47390-05
5 mm



47392-03
3 mm



47392-04
4 mm



47392-05
5 mm

Kapselmesser
Capsulotorz knife
Cuchillo para capsula
Coltello per capsula



FOERSTER
47394-27 27 cm, 10 1/2"

Septum Elevatoren
Septum Elevators
Elevadores para el tabique
Elevatori per setto

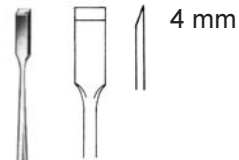

FREER
47450-04
15 cm, 6"

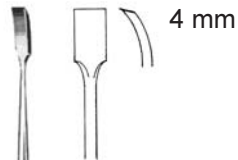

FREER
47451-04
15 cm, 6"

Septum Meißel, Osteotome
 Rhinoplastic Chisels, Osteotomes
 Cinceles para la plástica nasal, Osteotomos
 Scalpelli per plastica nasale, Osteotomi

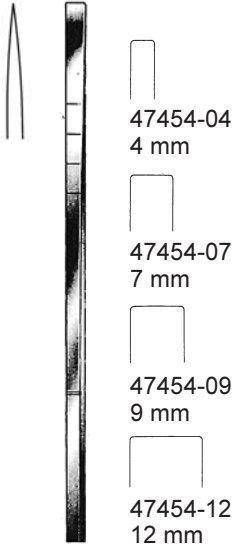

COTTLE
18 cm, 7"



COTTLE
47455-06
18 cm, 7"

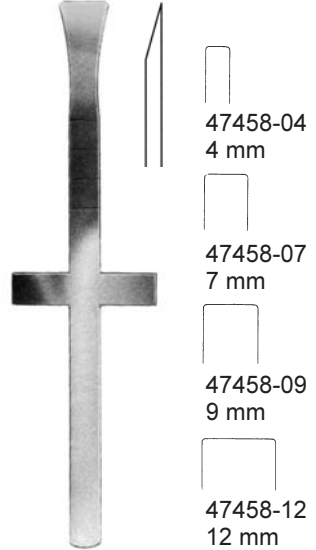

COTTLE
18 cm, 7"

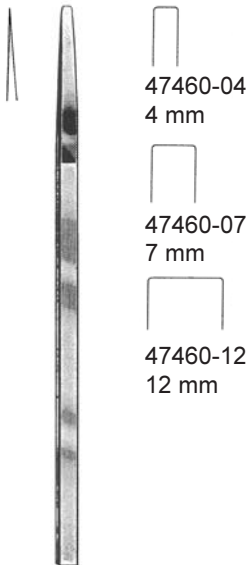

COTTLE
18 cm, 7"

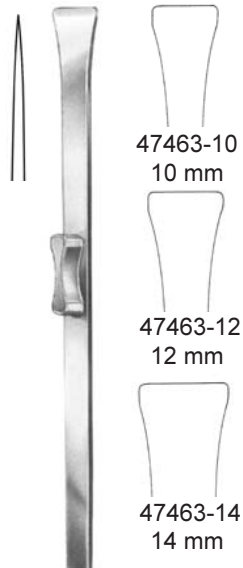

RUBIN
18,5 cm, 7 1/4"

Osteotome, Septum Meißel
 Osteotomes, Rhinoplastic Chisels
 Osteotomo, Cinceles para la plástica nasal
 Osteotomi, Scalpelli per plastica nasale

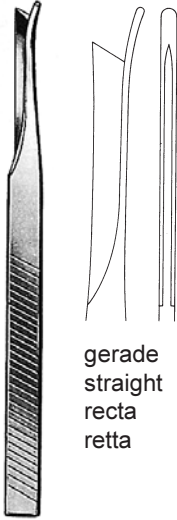

gerade
 straight
 recta
 retta

SILVER
 47473-01
 18 cm, 7"

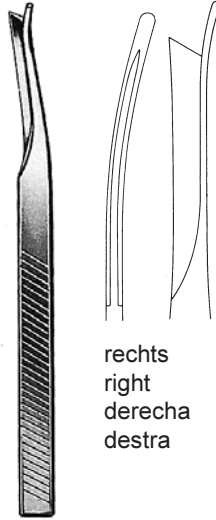

rechts
 right
 derecha
 destra

SILVER
 47473-02
 18 cm, 7"

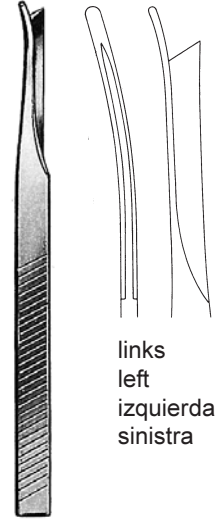

links
 left
 izquierda
 sinistra

SILVER
 47473-03
 18 cm, 7"

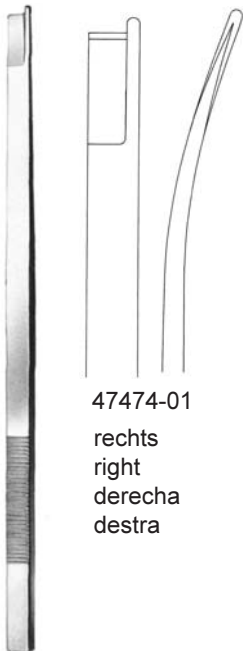

47474-01
 rechts
 right
 derecha
 destra

NEIVERT-ANDERSON
 20,5 cm, 8" 7 mm



47474-02
 links
 left
 izquierda
 sinistra



47474-03
 gerade
 straight
 recta
 retta



KILLIAN
 47481-05 16 cm, 6 1/4"

Osteotome
Osteotomes
Osteotomo
Osteotomi



47475-04
47475-06
47475-08

4 mm
6 mm
8 mm

OBWEGESER
18,5 cm, 7¹/₄"

Septum Meißel, Osteotome, Hohlmeißel
 Rhinoplastic Chisels, Osteotomes, Gouges
 Cinceles para la plástica nasal, Osteotomos, Gubias
 Scalpelli per plastica nasale, Osteotomi, Sgorbie



KILLIAN-CLAUS
 47482-05
 17 cm, 6³/₄"



HAJEK
 47484-04 4 mm
 47484-06 6 mm
 47484-08 8 mm
 16 cm, 6¹/₄"



WEST
 47486-16
 16 cm, 6¹/₄"



WEST
 47487-16
 16 cm, 6¹/₄"



FREER
 47489-16
 16 cm, 6¹/₄"

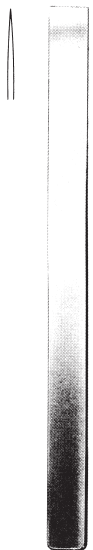

2 mm



3 mm



4 mm



5 mm



6 mm



8 mm



10 mm



12 mm



15 mm

12,5 cm, 5"

- 33654-02
- 33654-03
- 33654-04
- 33654-05
- 33654-06
- 33654-08
- 33654-10
- 33654-12
- 33654-15

mm

- 2
- 3
- 4
- 5
- 6
- 8
- 10
- 12
- 15

17 cm, 6³/₄"

- 33652-02
- 33652-03
- 33652-04
- 33652-05
- 33652-06
- 33652-08
- 33652-10
- 33652-12
- 33652-15

MINI-LAMBOTTE

Knorpelquetscher
Cartilage crusher
Macha cadera
Tritacartilagine



COTTLE
47461-00 7,5 cm, 3"

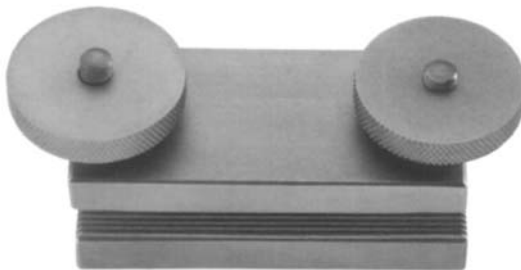

JOST
47462-00

Nasenraspeln
 Nasal Rasps
 Escofinas nasales
 Raspa nasale



JOSEPH
 47502-16 16 cm, 6 1/4"



MALTZ
 47504-18 18 cm, 7"

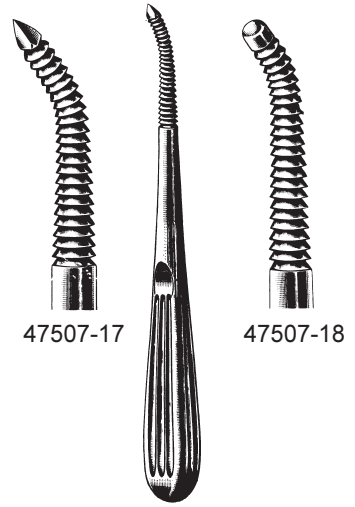

47507-17

47507-18

WIENER
 18 cm, 7"



diamantiert
 with diamond coating
 con boca de diamante
 diamantata

PEET
 47523-01 19 cm 7 1/2" 47523-02



GLABELLA
 47524-01 21 cm, 8 1/4"



47525-20
 fein, fine, fino, fina
 20 Zähne
 20 teeth
 20 dientes
 20 denti

47526-20
 grob, coarse, gruesa, grossa
 11 Zähne
 11 teeth
 11 dientes
 11 denti

PARKES
 47525-20 21 cm, 8 1/4"

Nasenraspeln
 Nasal Rasps
 Escofinas nasales
 Raspa nasale

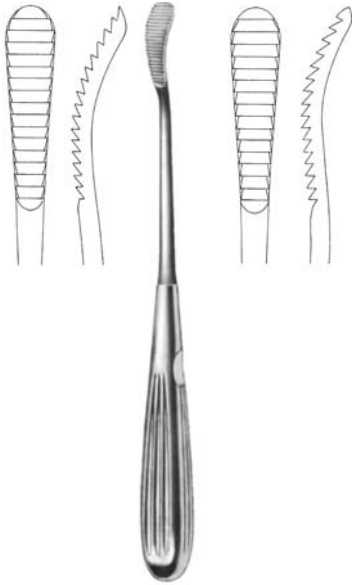

AUFRICHT
 47511-21 21 cm, 8 1/4" 47513-21

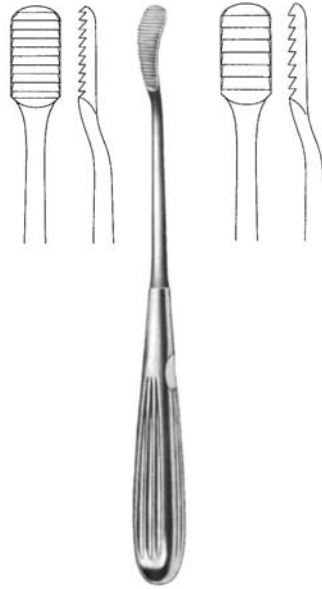

JOSEPH (LEWIS)
 47514-16 18 cm, 7" 47516-16

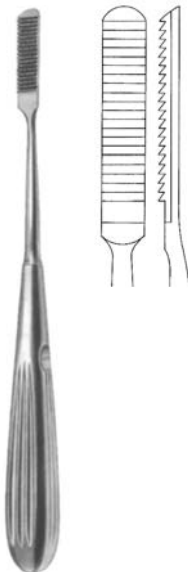

MALTZ (COTTLE)
 47518-21 21 cm, 8 1/4"

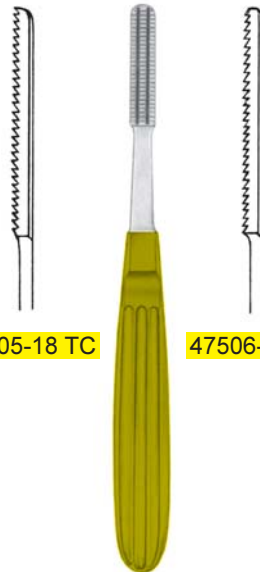

47505-18 TC

47506-18 TC

MALTZ
 17,5 cm, 6.9"

Nasenraspeln
Nasal Rasps
Escofinas nasales
Raspa nasale

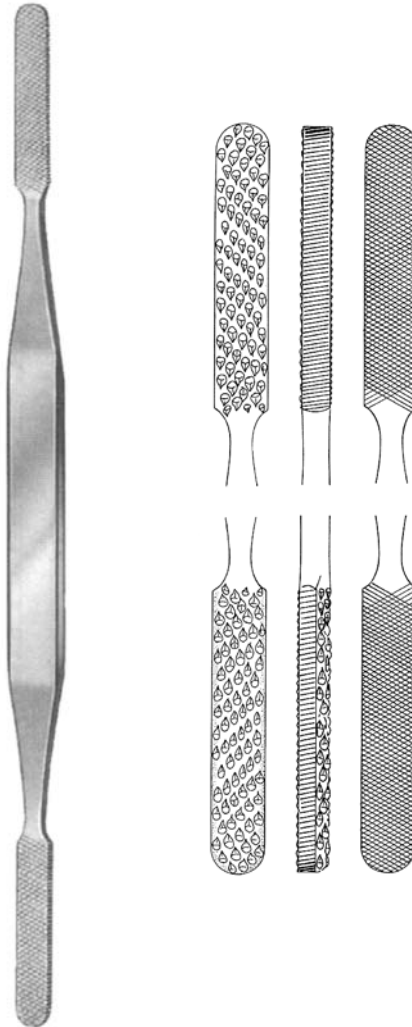

FOMON
47520-21
21 cm, 8¹/₄"

Nasenraspeln
Nasal Rasps
Escofinas nasales
Raspa nasale

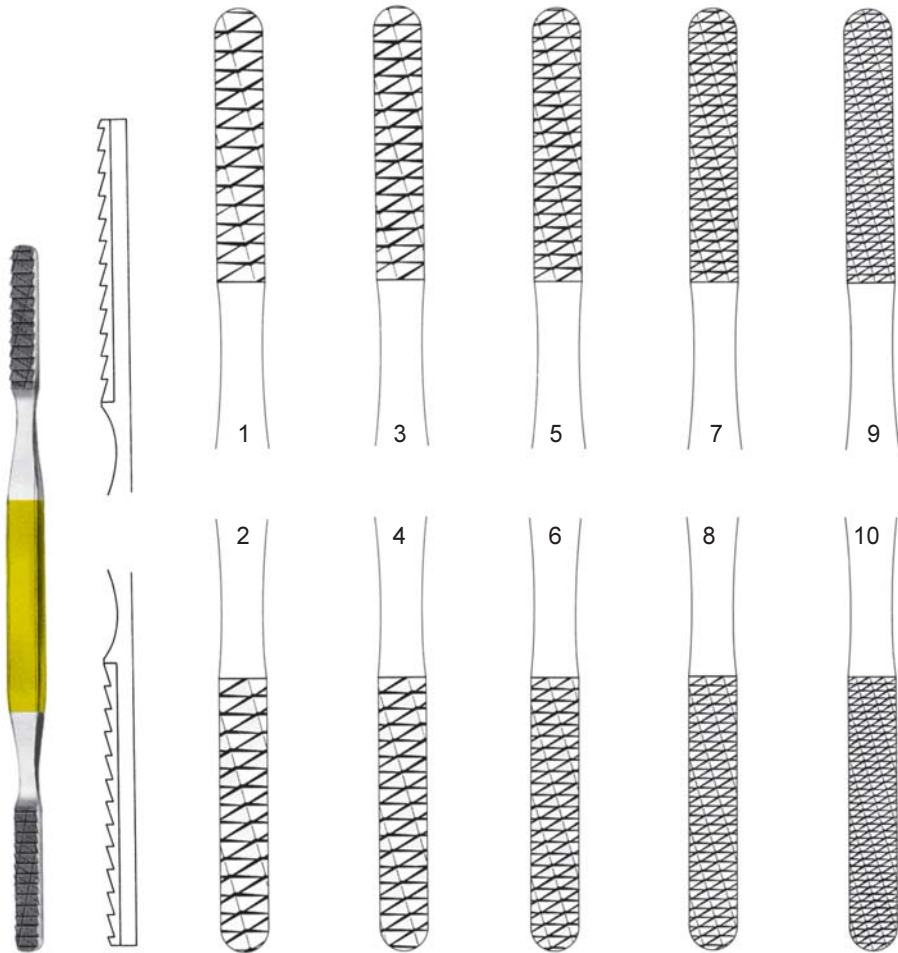

FOMON

47522-01TC - 47522-09 TC

20 cm, 8"

Fig. 1/2

47522-01 TC

Fig. 3/4

47522-04 TC

Fig. 5/6

47522-05 TC

Fig. 7/8

47522-07 TC

Fig. 9/10

47522-09 TC

Nasenraspeln, Nasensägen
 Nasal Rasps, Nasal Saws
 Escofinas nasales, Sierras nasales
 Raspa nasale, Seghe nasale

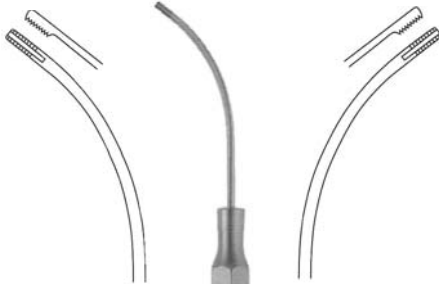

47530-01
 Fig. 1

47530-02
 Fig. 2



Drahtbürste zum Reinigen von Raspeln
 Wirebrush for cleaning the rasps
 Cepillo de alambre para limpiar las escofinas
 Spazzolino di fili metallici per pulire le raspe

DINGMAN Set
 47530-00 15 cm, 6"

47531-00 16 cm, 6 1/4"

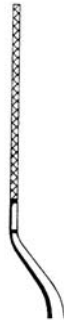

47533-19

47532-19

47534-19

gerade
 straight
 recta
 retta

links
 left
 izquierda
 sinistra

rechts
 right
 derecha
 destra

JOSEPH
 19 cm, 7 1/2"

Nasensägen
Nasal Saws
Sierras nasales
Seghe nasale



JOSEPH
47535-01 17 cm, 6³/₄" 47535-02

Septumrichtzangen
Septum Straightening Forceps
Pinza para enderezar el tabique nasal
Pinza per la plastica nasale



ASCH
47571-23
23 cm, 9"



WALSHAM
47572-23
23 cm, 9"

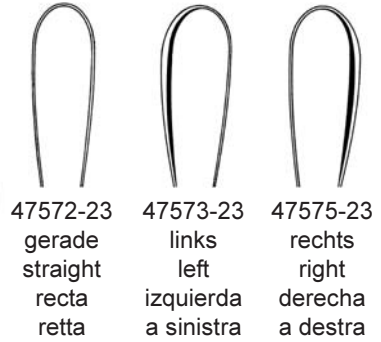

Zungendrucker, Mundsperrer
Tongue Depressors, Mouth Gags
Boja-lengua, Abre-Bocas
Abbassalingua, Apribocca



WIEDER



49115-01
Fig. 1
14 cm, 5 1/2"



49115-02
Fig. 2
15 cm, 6"



ANDREW
49117-11
11 cm, 4 3/8"

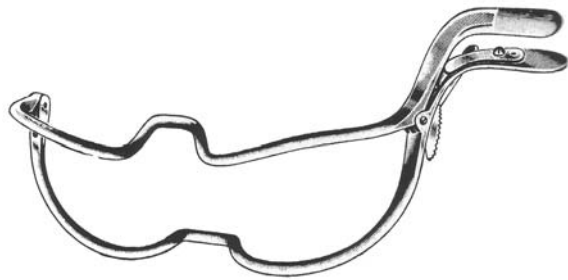

JENNINGS
49274-09 9 cm, 3 1/2"
49274-11 11 cm, 4 3/8"
49274-13 13 cm, 5 1/8"
49274-15 15 cm, 6"

Mundsperrer
 Mouth Gags
 Abre-Bocas
 Apribocca

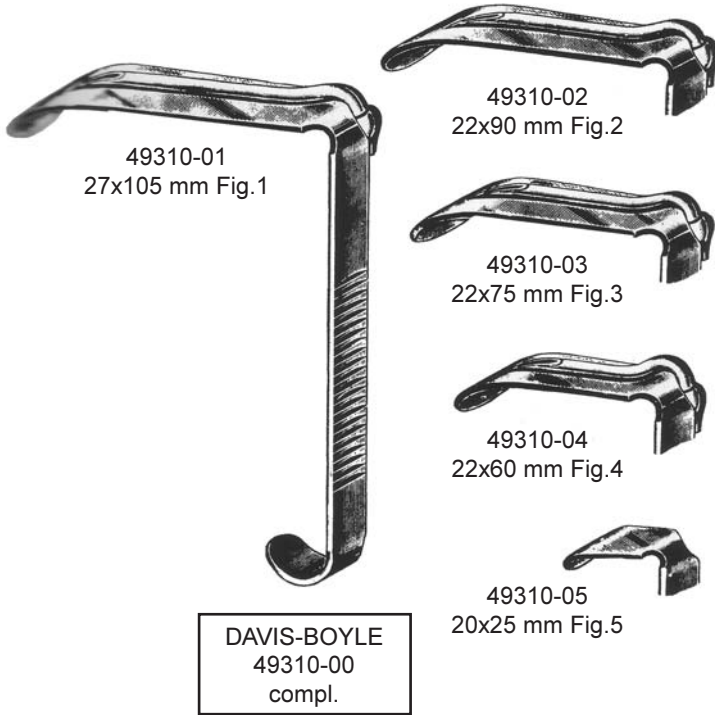

	für Erwachsene for adults para adultos per adulti	für Kinder for children para niños per bambini
links left izquierda sinistra	49310-10	49310-11
rechts right derecha destra	49310-12	49310-09

Mundsperrer
 Mouth Gags
 Abre-Bocas
 Apribocca

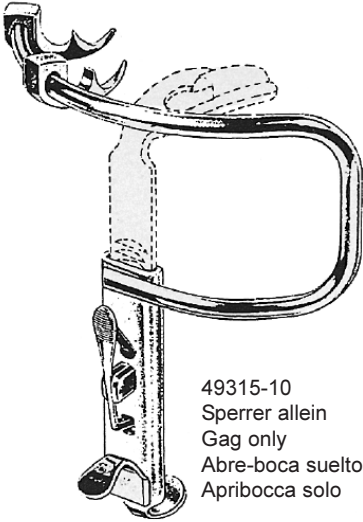

49315-10
 Sperrer allein
 Gag only
 Abre-boca suelto
 Apribocca solo

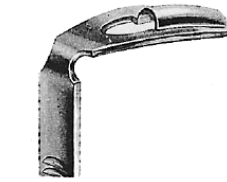

49315-01
 Fig.1

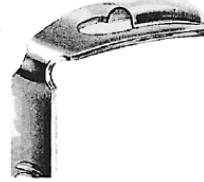

49315-02
 Fig.1



49315-03
 Fig.1

KILNER-DOUGHTY
 49315-00
 compl.

49317- 00 DINGMANN, komplett
 mit 3 auswechselbaren Zungendrucker,
 2 seitliche Wangenhaken und 2 Zahnhaken

con 3 baja lenguas intercambiables
 2 valvas giratorias p. los labios
 2 ganchos graduables

with 3 interchangeable tongue depressors,
 2 rotating cheek holders,
 2 movable tooth hooks and thread guide

con 3 depressori intercambiabili,
 2 valve laterali rotative,
 2 uncini a denti mobile

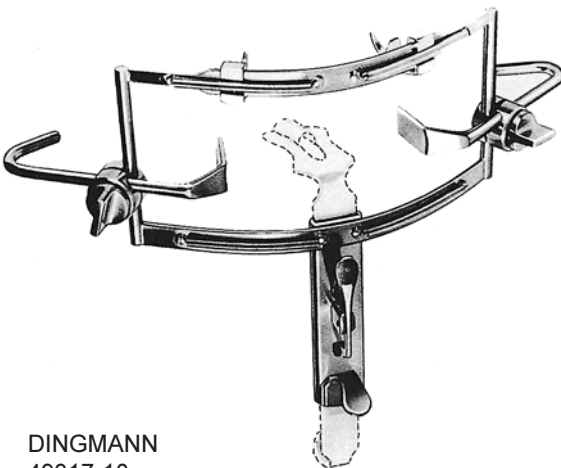

DINGMANN
 49317-10
 Sperrer allein, Gag only
 Abre-boca suelto, Apribocca solo



1 24x62 mm
 49317-01



2 28x65 mm
 49317-02

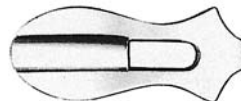

3 31x75 mm
 49317-03

Mundsperrer, Zungenspatel
Mouth Gags, Tongue depressor
Abre-Bocas, Baja-lengua
Apribocca, Abbassalingua

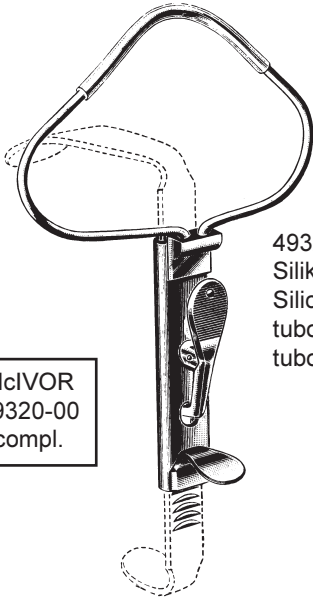

49320-10

49320-20
Silikon-Schlauch
Silicon Tubing
tubo de silicona
tubo in silicone

McIVOR
49320-00
compl.

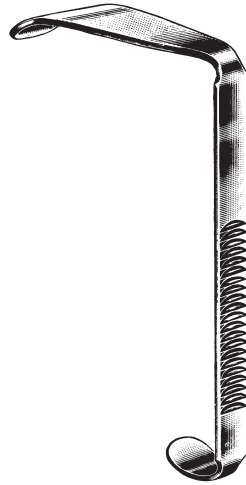

49320-01
27x95 mm Fig.1

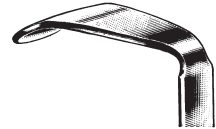

49320-02
22x85 mm Fig.2

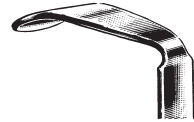

49320-03
22x75 mm Fig.3



DAVIS-MEYER
49340-00

Zungenspatel
Tongue blades
Baja-lenguas
Abbassalingua



RUSSEL-DAVIS

Wundhaken für Mund-Kiefer-Gesicht
Retractors, Raspatories for Mouth-, Jaw- and Face Surgery
Separadores para cirugía de boca -mandíbula- fiscal
Divaricatori, Periostotomi per bocca, mascella, viso



OBWEGESER
22 cm, 8³/₄"

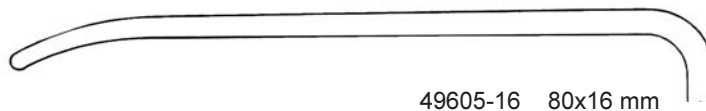
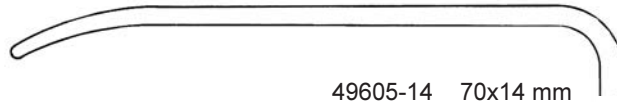
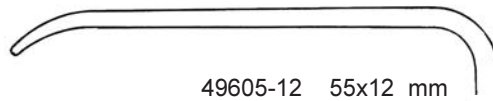
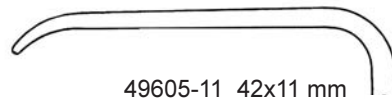
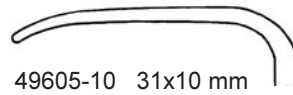

Wundhaken für Mund-Kiefer-Gesicht
Retractors, Raspatories for Mouth-, Jaw- and Face Surgery
Separadores para cirugía de boca -mandíbula- facial
Divaricatori, Periostotomi per bocca, mascella, viso



OBWEGESER
22 cm, 8³/₄"

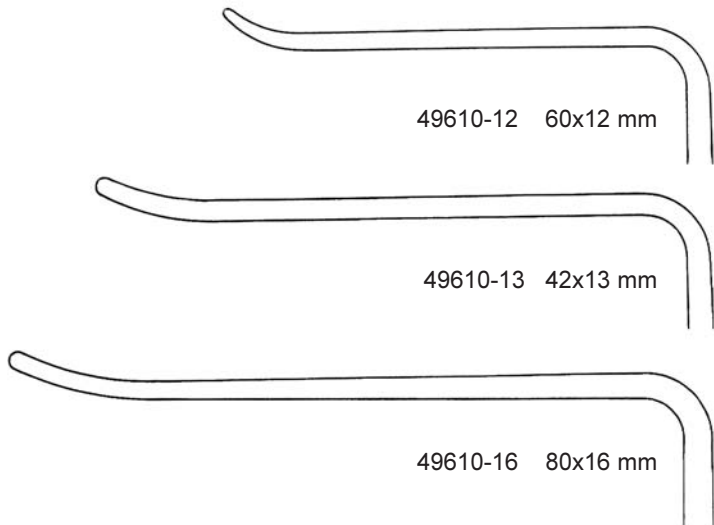

Wundhaken für Mund-Kiefer-Gesicht
 Retractors, Raspatories for Mouth-, Jaw- and Face Surgery
 Separadores para cirugía de boca- mandíbula- fiscal
 Divaricatori, per bocca, mascella, viso

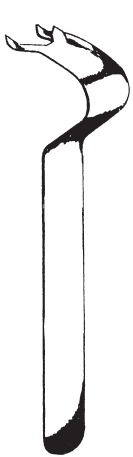
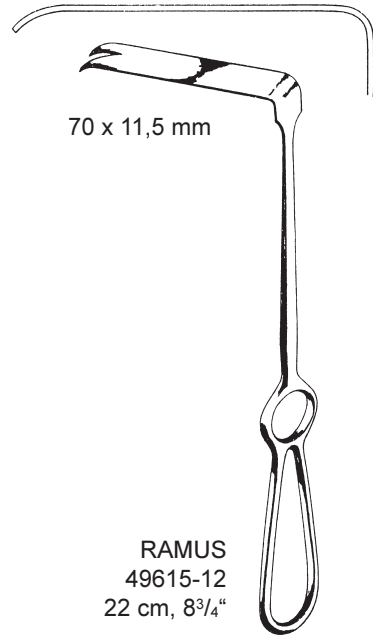
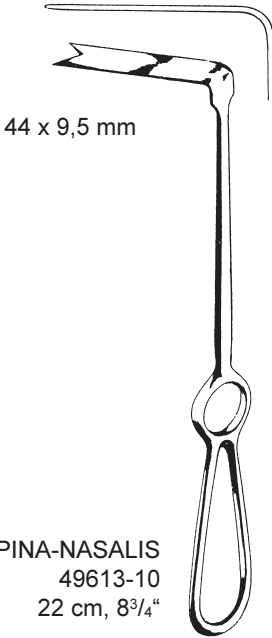

OBWEGESER
 49620-15
 15,5 cm, 6"

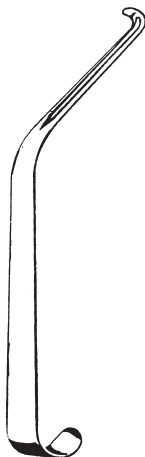

OBWEGESER
 49623-16
 16 cm, 6¹/₄"



OBWEGESER
 49627-01
 21 cm, 8¹/₄"

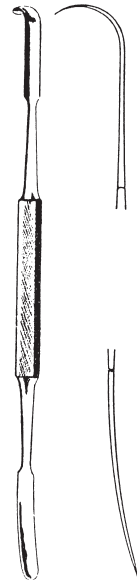

OBWEGESER
 49630-02
 20,5 cm, 8"

Raspatorien, Elevatoren
 Periosteal Elevators
 Legras
 Periostotomi

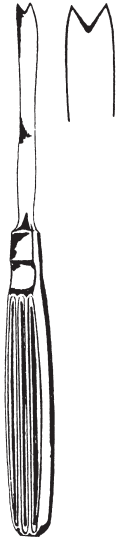

OBWEGESER
 49635-18 17,5 cm, 7"



OBWEGESER
 20 cm, 8"

5 mm



49640-05

7 mm



49640-07

9 mm



49640-09



OBWEGESER
 17,5 cm, 7"

6 mm



49650-06

7 mm



49650-07

9 mm



49650-09

11 mm



49650-11

Raspator, Wundhaken, Elevator
 Raspatories, Retractor, Elevators
 Legras, Separadores, Elevadores
 Periostotomo, Divaricatore, Elevatore

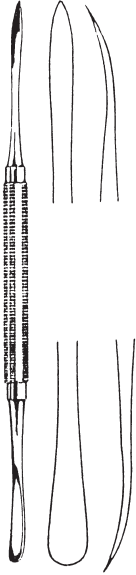

DINGMAN
 49660-18 18 cm, 7"



19 cm, 7 1/2"

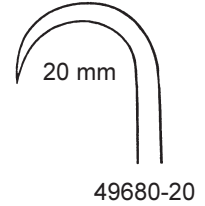
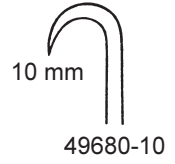

DINGMAN
 49685-21 21 cm, 8 1/4"

links left
 izquierda sinistra

rechts right
 derecha destra

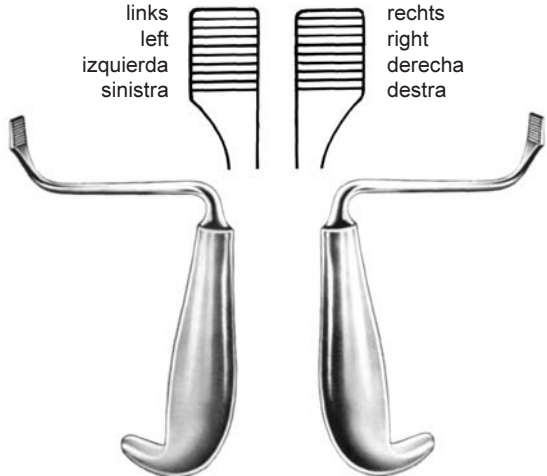

TESSIER
 49691-15 15 cm, 6"

TESSIER
 49692-15 15 cm, 6"

Osteotome
Osteotome
Osteótomos
Osteotomi



49666-10 10 mm
49666-15 15 mm
49666-20 20 mm

TESSIER
20,5 cm 8"



49667-10 10 mm
49667-15 15 mm

TESSIER
20,5 cm 8"



7 mm

49700-01
21,5 cm, 8 1/2"



10 mm

49700-02
21,5 cm, 8 1/2"

Endoskopische Instrumente
Endoscopic Instruments
Instrumentos para endoscopia
Strumenti endoscopici

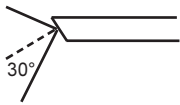
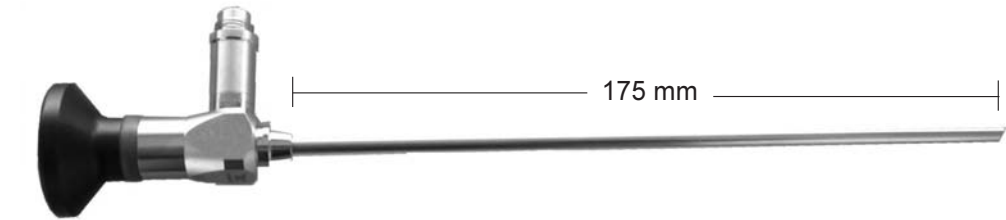

Vorausblick	30°	R600-040175-030
Foroblique vision	30°	
Visión hacia adelante	30°	
Grandangolo, visione	30°	

Endoskop für plastische Chirurgie 4 mm Ø, 30° Blickrichtung, 175 mm Nutzlänge, autoklavierbar, integrierte Faser für Ausleuchtung

Endo-Plastic-Scope 4 mm Ø, 30° direction of view, 175 mm working length, autoclavable, integrated fiberoptic bundle for illumination

Optica para endoplastia de 4 mm Ø, vision de 30°, largo útil de 175 mm, autoclavable, con fibra-optica para la iluminación

Optica per endoplastica 4 mm Ø, visione 30°, lunghezza utile 175 mm, autoclavabile con fibre ottiche per illuminazione

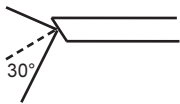
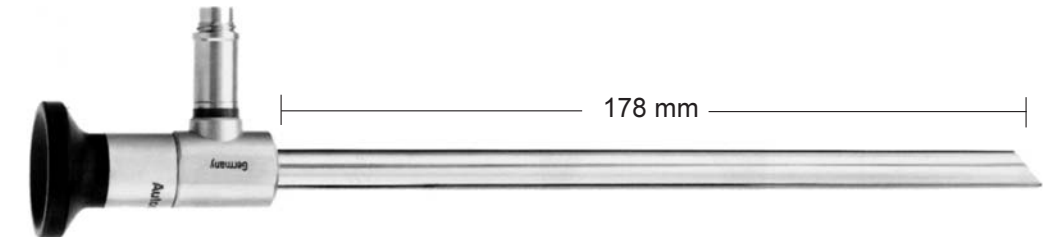

Vorausblick	30°	R600-100178-030
Foroblique vision	30	
Visión hacia adelante	30°	
Grandangolo, visione	30°	

Endo-Plastik-Optik 10 mm Ø, 30° Blickrichtung, 178 mm Nutzlänge, autoklavierbar, integrierte Fiberoptik für Ausleuchtung

Endo-Plastic-Scope 10 mm Ø, 30° direction of view, 178 mm working length, autoclavable, integrated fiberoptic bundle for illumination

Optica para endoplastia de 10 mm Ø, vision de 30°, largo útil de 178 mm, autoclavable, con fibra-optica para la iluminación

Optica per endoplastica 10 mm Ø, visione 30°, lunghezza utile 178 mm, autoclavabile con fibre ottiche per illuminazione



Schaft für Plastische Chirurgie mit 1 Hahn, drehbar, passend für 4 mm Optik mit 175 mm Nutzlänge

Endo-Plastic Sheath with spatula, 1 stopcock rotatable, for 4 mm scope with 175 mm work. length

Camisa para cirugía plástica, una llave giratoria, para óptica de 4 mm, largo útil de 175 mm

Camicia per chirurgia plastica, con spatola, 1 rubinetto rotante, per ottica 4 mm, lunghezza 175 mm

7x17 mm gefenstert / 7x17 mm fenestrated
7x17 mm fenestrada / 7x17 mm fenestrata

R610-040175-070

11x17 mm gefenstert / 11x17 mm fenestrated
11x17 mm fenestrada / 11x17 mm fenestrata

R610-040175-110

11x23 mm gefenstert / 11x23 mm fenestrated
11x23 mm fenestrada / 11x23 mm fenestrata

R610-040175-115

Endoskopische Instrumente
Endoscopic Instruments
Instrumentos para endoscopia
Strumenti endoscopici



R610-040175-001

Schaft für Plastische Chirurgie, schnabelförmig, breit/flach, 1 Hahn, drehbar,
passend für 4 mm Optik mit 175 mm Nutzlänge

Endo-Plastic Sheath with oblique beak wide/flat, 1 stopcock rotatable,
suitable f. 4 mm scope with 175 mm working length

Camisa para cirugía plástica en forma de pico, ancho y plano, con una llave giratoria,
para óptica de 4 mm, largo útil de 175 mm

Camicia per chirurgia plastica, a forma di becco, larga/piatta, 1 rubinetto rotante,
per ottica 4 mm, lunghezza utile 175 mm

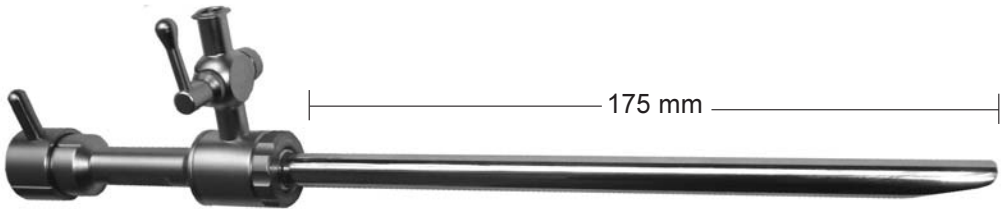

R610-040175-005

Schaft für Plastische Chirurgie, schnabelförmig, 1 Hahn, drehbar, passend für 4 mm Optik mit 175 mm Nutzlänge

Endo-Plastic Sheath with oblique beak, 1 stopcock rotatable, suitable f. 4 mm scope with 175 mm working length

Camisa para cirugía plástica en forma de pico, con una llave giratoria, para óptica de 4 mm, largo útil de 175 mm

Camicia per chirurgia plastica, a forma di becco, 1 rubinetto rotante, per ottica 4 mm, lunghezza utile 175 mm

Endoskopische Instrumente
Endoscopic Instruments
Instrumentos para endoscopia
Strumenti endoscopici

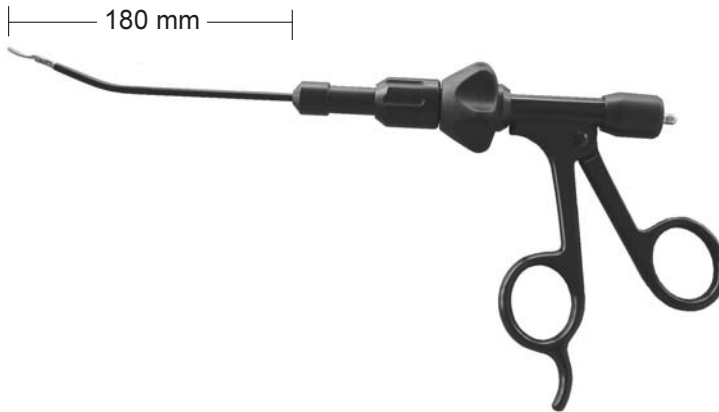

R631-030160-110

Schere gerade, drehbar für rechte und linke Anwendung, 3 mm Ø,
Griff mit HF-Anschluß, isoliert

Endoscopic Scissors, straight, insulated shaft, 3 mm Ø,
handle with HF connector, rotatable

Tijera recta, giratoria, para su aplicación hacia la derecha y la izquierda,
3 mm Ø, mango con contacto de alta frecuencia, aislada
Forbice, retta, 3 mm Ø, rotante, per uso a destra e a sinistra,
impugnatura con attacco per alta frequenza



R631-030160-112

Schere Metzenbaum, gebogen, drehbar für rechte und linke Anwendung,
3 mm Ø, Griff mit HF-Anschluß, isoliert

Endoscopic Metzenbaum Scissor, curved, insulated shaft, 3 mm Ø,
handle with HF connector, rotatable

Tijera curva, giratoria, para su aplicación hacia la derecha y la izquierda,
3 mm Ø, mango con contacto de alta frecuencia, aislada
Forbice Metzenbaum, curva, 3 mm Ø, rotante, per uso a destra e a
sinistra, impugnatura con attacco per alta frequenza



R631-030160-116

Hakenschere, drehbar für rechte und linke Anwendung, 3 mm Ø,
Griff mit HF-Anschluß, isoliert

Endoscopic Micro Hook Scissor, curved shaft for left or right hand,
3 mm Ø, handle with HF connector, rotatable

Tijera de pico, giratoria, para su aplicación hacia la derecha y la izquierda,
3 mm Ø, mango con contacto de alta frecuencia, aislada
Forbice ad uncino, curva, 3 mm Ø, rotante, per uso a destra e a sinistra,
impugnatura con attacco per alta frequenza

Endoskopische Instrumente
Endoscopic Instruments
Instrumentos para endoscopia
Strumenti endoscopici



R631-030160-212

Maryland Faszange gebogen, drehbar, für rechte und linke Anwendung, 3 mm Ø, Griff mit HF-Anschluß, isoliert

Endoscopic Curved Grasper, rotating, insulated shaft for left and right, 3 mm Ø, handle with HF connector

Pinza de agarre raspar tipo Maryland, giratoria, para su aplicación hacia la derecha y la izquierda, 3 mm Ø, mango con contacto de alta frecuencia, aislada
Pinza da presa Maryland, curva, rotante, per uso a destra e a sinistra, Ø 3 mm, impugnatura con attacco per alta frequenza



R631-030160-224

Delphinzange, drehbar für rechte und linke Anwendung, 3 mm Ø, Griff mit HF-Anschluß, isoliert

Endoscopic Needle Nose Grasper, rotatable for left and right use, 3 mm Ø, handle with HF connector

Pinza de agarre en forma de delfino, giratoria, para su aplicación hacia la derecha y la izquierda, 3 mm Ø, mango con contacto de alta frecuencia, aislada
Pinza da presa, rotante, per uso a destra e a sinistra, morso a delfino, Ø 3 mm, impugnatura con attacco per alta frequenza



R631-030160-246

Faßzange, retrograd gezahnt, drehbar für rechte und linke Anwendung, 3 mm Ø, Griff mit HF-Anschluß, isoliert

Endoscopic Heavy Grasper, rotatable for left and right, insulated, 3 mm Ø, handle with HF connector

Pinza de agarre, con dentadura en forma retrógrada, giratoria, para la aplicación hacia la derecha y la izquierda, 3 mm Ø, mango con contacto de alta frecuencia, aislada

Pinza da presa, retrograda, rotante, per uso a destra e a sinistra, 3 mm Ø, impugnatura con attacco per alta frequenza

Endoskopische Instrumente
Endoscopic Instruments
Instrumentos para endoscopia
Strumenti endoscopici

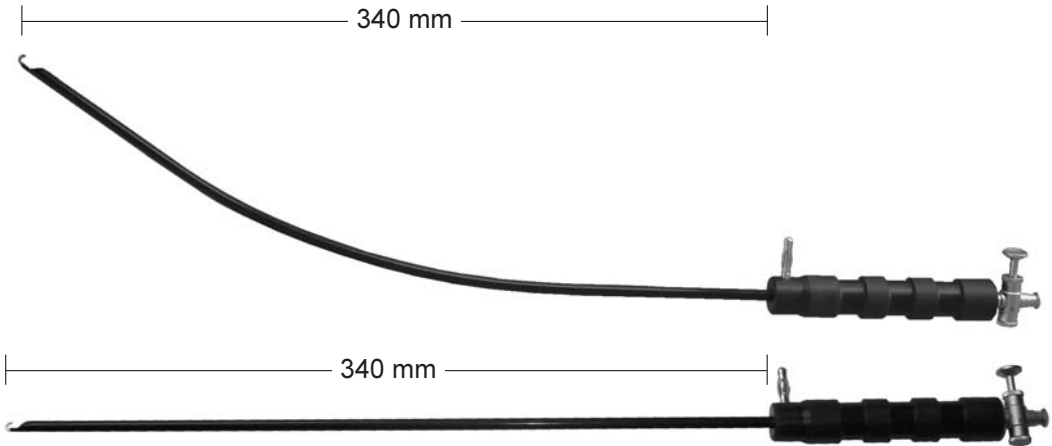

Monopolare Elektroden mit Saugkanal und Hahn, 5 mm Ø, 340 mm Nutzlänge
Monopolar electrodes with suction port and stopcock, 5 mm Ø, 340 mm working length
Electrodos monopolares con canal de succión y llave de 5 mm Ø, largo útil de 340 mm
Elettrodi monopolari con canale d'aspirazione e rubinetto, 5 mm Ø, lunghezza utile 340 mm



J-Haken Elektrode, gerade
J-Hook electrode straight
Electroda forma de gancho, recta
Elettrodo ad uncinetto, retto

R660-050340-002

J-Haken Elektrode, gebogen
J-Hook electrode curved
Electroda forma de gancho, curva
Elettrodo ad uncinetto, curvo

R661-050340-002



Spatel Elektrode, gerade
Spatula electrode straight
Electroda en forma de espátula, recta
Elettrodo a spatola, retto

R660-050340-004

Spatel Elektrode, gebogen
Spatula electrode curved
Electroda en forma de espátula, curva
Elettrodo a spatola, curvo

R661-050340-004

SET/100 Basic Plastic Surgery – Basis Set Plastische Chirurgie

1x	07103-00	scalpel handle no. 3
1x	07115-00	scalpel blade fig. 15
1x	09305-14	JOSEPH, scissors, cvd., 14,5 cm
1x	09310-12	KILNER, scissors, cvd., 12 cm
1x	09340-11	IRIS, scissors, str., 11 cm
1x	09341-11	IRIS, scissors, cvd., 11 cm
2x	11176-12	ADSON micro, dressing forceps, 12 cm
2x	11186-12	ADSON micro, tissue forceps, 1x2 t., 12 cm
4x	13220-12	HALSTED-MOSQUITO, forceps, str., 12,5 cm
6x	13221-12	HALSTED-MOSQUITO, forceps, cvd., 12,5 cm
2x	13320-14	ROCHESTER-OCHSNER, forceps, 1x2 t., str., 14 cm
4x	15111-09	BACKHAUS, towel forceps, 9 cm
2x	17170-18	FOERSTER, swab forceps, str., 18 cm
1x	19216-01	JOSEPH, hooklet, sharp, 1 prong, 16 cm
1x	19216-02	JOSEPH, hooklet, sharp, 2 prongs, 16 cm
1x	19650-10	WEITLANER, retractor, sharp, 11,5 cm
1x	21110-14	grooved director, 14,5 cm
1x	25137-11	BABY WEBSTER, needle holder TC, 11 cm
1x	25164-15	CRILE-WOOD, needle holder TC, 15 cm
1x	47560-18	GILLIES, hooklet, delicate, fig. 1, 18cm
2x	65110-15	ALLIS, tissue forceps, 4x5 t., 15 cm
1x	89127-08	bowl round, stainless steel, 80x40 mm, 0,14 l

SET/101 Abdominoplasty Set – Abdominoplastik Set

1x	07104-00	scalpel handle no. 4
1x	07120-00	scalpel blade fig. 20
1x	09165-14	MAYO, scissors TC, cvd., 14,5 cm
1x	10039-23	KAYE, face lift Supercut scissors, cvd., 23 cm
1x	10011-19	GORNEY, face lift scissors, cvd., 18,5 cm
1x	11112-18	POTTS-SMITH, dressing forceps, 18 cm
1x	11126-18	POTTS-SMITH, tissue forceps, 1x2 t., 18 cm
1x	11176-12	ADSON micro, dressing forceps, 12 cm
1x	11186-12	ADSON mirco, tissue forceps, 1x2 t., 12 cm
1x	11188-12	ADSON-BROWN, tissue forceps, 7x7 t., 12 cm
6x	15111-13	BACKHAUS, towel forceps, 13 cm
1x	19102-12	FARABEUF, retractor, double pair, 12 cm
2x	19216-07	JOSEPH, hooklet, sharp, 2 prongs, 16 cm
1x	19364-60	ISRAEL, retractor, blunt, 50x60 mm, 25 cm
1x	25144-13	HALSEY, needle holder TC, 13 cm
1x	25184-16	MAYO-HEGAR, needle holder TC, 16 cm
1x	25184-20	MAYO-HEGAR, needle holder TC, 20 cm

SET/102 Skin Graft Set – Hautverpflanzung Set

1x	03350-15	tape measure metal, 1,5 m
1x	07103-00	scalpel handle no. 3
1x	07115-00	scalpel blade fig. 15
1x	07490-00	SCHINK, dermatome, 30 cm
1x	09283-15	METZENBAUM-FINO, scissors, cvd, 15 cm
1x	09283-18	METZENBAUM-FINO, scissors, cvd., 18 cm
1x	11260-15	SEMKEN. dressing forceps, 15,5 cm
1x	11270-15	SEMKEN, tissue forceps, 1x2 t., 15,5 cm
3x	13221-12	HALSTED-MOSQUITO, forceps, cvd., 12,5 cm
4x	15111-13	BACKHAUS, towel forceps, 13 cm
1x	19212-01	GUTHRIE, double hooklet, small, 12 cm
1x	19240-10	SENN-GREEN, retractor, 10x6mm, 15cm
1x	25214-18	DeBAKEY, needle holder TC, 18 cm
1x	25164-15	CRILE-WOOD, needle holder TC, 15 cm
1x	47560-18	GILLIES, hooklet, delicate, fig. 1, 18 cm
2x	65110-15	ALLIS, tissue forceps, 4x5 t., 15 cm

SET/103 Nose Correction – Nasenkorrektur Set

1x	07107-00	scalpel handle no. 7
1x	07115-00	scalpel blade fig. 15
1x	09304-14	JOSEPH, scissors, str., 14 cm
1x	09310-12	KILNER, scissors, cvd., 12 cm
1x	09321-15	REYNOLDS, scissors, cvd., 15 cm
1x	09401-18	HEYMANN, scissors, 18 cm
1x	11176-12	ADSON micro, dressing forceps, 12 cm
1x	11186-12	ADSON micro, tissue forceps, 1x2 t., 12 cm
1x	11188-12	ADSON-BROWN, tissue forceps, 7x7 t., 12 cm
1x	13220-12	HALSTED-MOSQUITO, forceps, str., 12,5 cm
1x	13223-12	HALSTED-MOSQUITO, forceps, cvd., 12,5 cm
1x	13312-14	PEAN, forceps, str., 14 cm
4x	15111-13	BACKHAUS, towel forceps, 13 cm
1x	17111-20	GROSS-MAIER, dressing forceps, cvd., 20 cm
1x	19212-01	GUTHRIE, double hooklet, 12 cm
1x	19216-02	JOSEPH, hooklet, sharp, 2 prongs, 16 cm
1x	19218-01	BARSKY, hook, 15 cm
1x	19230-12	DESMARRES, retractor, 16 cm
1x	25137-11	BABY WEBSTER, needle holder TC, 11 cm
1x	25164-15	CRILE-WOOD, needle holder TC, 15 cm
1x	33100-01	FRIEDMAN micro, bone rongeur, str., 14 cm
1x	33694-01	mallet with interchangeable plastic, 18,5 cm
1x	33711-16	WILLIGER, raspatory, str., 16cm
1x	33711-20	LANGENBECK, elevator, 20 cm
1x	45206-14	LUCAE, ear forceps, 14 cm
1x	47120-35	KILLIAN, nasal speculum, 35 mm, 13 cm
1x	47120-50	KILLIAN, nasal speculum, 50 mm, 13 cm
1x	47224-01	WEIL-BLAKESLEY, forceps, fig. 1, 45°, 3 mm
1x	47256-20	CAPLAN, nasal cutting forceps, 20 cm
1x	47347-20	GUILLEN, suction raspatory, 19 cm
1x	47374-16	FREER, mucosa knife, 16,5 cm
1x	47423-22	COTTLE, septum elevator, 22 cm
1x	47454-04	COTTLE, rhinoplastic osteotome, 18 cm
1x	47454-07	COTTLE, rhinoplastic osteotome, 18 cm
1x	47470-04	FOMON, osteotome, 17 cm
1x	47522-05	FOMON, nasal raspel TC, fig. 5/6, 20 cm
1x	47551-16	AUFRICHT, nasal retractor, 16 cm
1x	47555-08	KILNER, nasal retractor, 8 cm
1x	47565-10	COTTLE, columella forceps, 10 cm
1x	47571-23	ASCH, septum forceps, str., 23 cm
1x	89127-08	bowl round, stainless steel, 80x40 mm, 0,14 l

SET/104 Face Lift Set

1x	03370-16	PITANGUY, facelift marker, 16 cm
1x	07107-00	scalpel handle no. 7
1x	07115-00	scalpel blade fig. 15
1x	09345-11	IRIS, scissors TC, cvd., 11 cm
1x	10015-19	GORNEY, face lift Supercut scissors, cvd., 18,5 cm
1x	10045-14	PECK-JOSEPH, dissecting scissors, cvd., 14,5 cm
1x	11176-12	ADSON micro, dressing forceps, 12 cm
1x	11186-12	ADSON micro, tissue forceps, 1x2 t., 12 cm
1x	11188-12	ADSON-BROWN, tissue forceps, 7x7 t., 12 cm
1x	11231-20	BROPHY, tissue forceps, 1x2 t., 20 cm
1x	13364-14	MARTEL, scalp flap forceps, 14 cm
1x	19102-12	FARABEUF, retractor double pair, 12 cm
1x	19216-02	JOSEPH, hooklet, sharp, 2 prongs, 16 cm
1x	19314-16	KOCHER-LANGENBECK, retractor, 21 cm
1x	19995-38	FREEMAN, retractor, sharp, 4 prongs, 18 cm
1x	25144-13	HALSEY, needle holder TC, 13 cm
1x	25164-15	CRILE-WOOD, needle holder TC, 15 cm
1x	47560-18	GILLIES, hooklet, delicate, fig. 1, 18 cm

SET/105 Eyelid Plastic (Blepharoplasty) – Set zur Lidstraffung (Blepharoplastik)

1x	07103-00	scalpel handle no. 3
1x	07115-00	scalpel blade fig. 15
1x	09341-11	IRIS, scissors, cvd., 11 cm
1x	09362-11	STEVENS, scissors, str. 11 cm
1x	10313-14	GOMEL, scissors, cvd., 14 cm
1x	11186-12	ADSON micro, tissue forceps, 1x2 t., 12 cm
1x	13220-12	HALSTED-MOSQUITO, forceps, str., 12,5 cm
1x	13221-12	HALSTED-MOSQUITO, forceps, cvd., 12,5 cm
4x	15111-09	BACKHAUS, towel forceps, 9 cm
1x	19216-01	JOSEPH, hooklet, sharp, 1 prong, 16 cm
1x	19216-02	JOSEPH, hooklet, sharp, 2 prongs, 16 cm
1x	19230-12	DESMARRES retractor, 16 cm
1x	25670-14	CASTROVIEJO, needle holder, str., 14 cm
1x	44150-01	CASTROVIEJO, suturing forceps, 0,1 mm, 10 cm
1x	47560-18	GILLIES, hooklet, delicate, fig. 1, 18 cm

SET/106 Mammoplasty – Mammoplastik Set

1x	03340-20	ruler metal, 20 cm
1x	03500-38	FREEMAN, marker, 38 mm
1x	03500-42	FREEMAN, marker, 42 mm
1x	03500-44	FREEMAN, marker, 44 mm
1x	07107-00	scalpel handle no. 7
1x	07115-00	scalpel blade fig. 15
1x	09281-18	METZENBAUM, scissors, 18 cm
1x	09310-15	KILNER, scissors, 15 cm
1x	09583-15	neurosurgery scissors, cvd., 15 cm
1x	11102-14	dressing forceps, 14,5 cm
1x	11186-12	ADSON micro, tissue forceps, 1x2 t., 12 cm
2x	13223-12	HALSTED-MOSQUITO, micro, forceps, cvd., 12,5 cm
2x	13231-12	HALSTED-MOSQUITO, forceps, cvd., 12,5 cm
1x	13475-18	MIXTER BABY, forceps, 18 cm
6x	15111-13	BACKHAUS, towel forceps, 13 cm
1x	17110-25	GROSS-MAIER, dressing forceps, 25 cm
1x	19102-12	FARABEUF, retractor double par, 12 cm
1x	19314-12	KOCHER-LANGENBECK, retractor, 21 cm
1x	19999-00	AGRIS-DINGMAN, breast dissector, set of 2, 36 cm
1x	19999-02	TEBBETTS, breast dissector, 33 cm
1x	25164-15	CRILE-WOOD, needle holder TC, 15 cm
1x	25180-16	MAYO-HEGAR, needle holder, 16 cm
1x	47154-20	JANSEN, nasal forceps, 20 cm
1x	89127-08	bowl round, stainless steel, 80x40mm, 0,14 l

03312-01.....2	07490-01.....5	09282-20.....17	09350-09.....23	09963-17.....13
03314-01.....2	07490-02.....5	09282-23.....17	09350-10.....22	09964-15.....14
03340-10.....2	07495-31.....6	09283-15.....17	09351-09.....23	09964-17.....14
03340-15.....2	07496-31.....6	09283-18.....17	09352-09.....23	09965-15.....14
03340-20.....2	07498-00.....6	09283-20.....17	09352-10.....22	09965-17.....14
03340-30.....2	07499-00.....6	09283-23.....17	09353-09.....23	09966-11.....16
03340-50.....2	07499-01.....6	09284-12.....16	09354-10.....23	09967-11.....16
03370-16.....3	09160-14.....13	09284-15.....16	09355-10.....23	09970-14.....16
03380-30.....3	09160-17.....13	09284-18.....16	09356-10.....23	09970-18.....16
03390-30.....3	09161-14.....13	09284-20.....16	09357-10.....23	09970-20.....16
03400-38.....4	09161-17.....13	09284-23.....16	09358-11.....22	09970-23.....16
03400-42.....4	09164-14.....13	09285-12.....16	09360-11.....24	09971-14.....16
03400-45.....4	09164-17.....13	09285-15.....16	09361-11.....24	09971-18.....16
03500-38.....4	09165-14.....13	09285-18.....16	09362-11.....24	09971-20.....16
03500-42.....4	09165-17.....13	09285-20.....16	09363-11.....24	09971-23.....16
03500-44.....4	09170-15.....14	09285-23.....16	09370-11.....24	09980-11.....20
07103-00.....7	09170-17.....14	09286-15.....17	09371-11.....24	09981-11.....20
07103-01.....7	09171-15.....14	09286-18.....17	09374-11.....24	09982-12.....25
07103-02.....7	09171-17.....14	09286-20.....17	09375-11.....24	09983-12.....25
07103-03.....7	09174-15.....14	09286-23.....17	09401-18.....27	09984-11.....24
07104-00.....8	09174-17.....14	09287-15.....17	09403-15.....27	09985-11.....24
07104-02.....8	09175-15.....14	09287-18.....17	09405-16.....27	09993-15.....19
07105-02.....8	09175-17.....14	09287-20.....17	09405-16TC.....27	09995-12.....19
07106-01.....8	09190-16.....15	09287-23.....17	09406-10.....27	10010-19.....30
07107-00.....9	09191-16.....15	09302-14.....18	09407-10.....27	10011-19.....30
07107-01.....9	09194-16.....15	09303-14.....18	09540-16.....19	10012-19.....30
07108-00.....9	09195-16.....15	09304-14.....18	09541-16.....19	10013-19.....30
07109-10.....10	09202-10.....15	09305-14.....18	09542-16.....19	10014-19.....30
07109-13.....10	09203-10.....15	09310-12.....19	09543-16.....19	10015-19.....30
07109-15.....10	09206-10.....15	09310-15.....19	09544-16.....19	10028-14.....31
07110-00.....11	09207-10.....15	09314-12.....19	09545-16.....19	10029-14.....31
07111-00.....11	09270-15.....17	09321-15.....19	09614-19.....29	10030-18.....31
07112-00.....11	09270-18.....17	09321-18.....19	09617-13.....27	10031-18.....31
07113-00.....11	09271-15.....17	09340-09.....20	09802-09.....28	10032-23.....31
07115-00.....11	09271-18.....17	09340-10.....20	09802-11.....28	10033-23.....31
07116-00.....11	09274-15.....17	09340-11.....20	09804-14.....28	10034-14.....31
07118-00.....11	09274-18.....17	09341-09.....20	09805-09.....28	10035-14.....31
07119-00.....11	09275-15.....17	09341-10.....20	09820-13.....29	10036-18.....31
07120-00.....11	09275-18.....17	09341-11.....20	09821-13.....29	10037-18.....31
07121-00.....11	09280-12.....16	09342-08.....20	09821-13SC.....29	10038-23.....31
07122-00.....11	09280-15.....16	09343-08.....20	09823-12.....25	10039-23.....31
07123-00.....11	09280-18.....16	09344-11.....20	09824-12.....25	10044-14.....31
07124-00.....11	09280-20.....16	09345-11.....20	09825-12.....25	10045-14.....31
07125-00.....11	09280-23.....16	09346-11.....20	09826-12.....25	10048-14.....31
07130-00.....11	09281-12.....16	09348-01.....21	09828-12.....25	10049-14.....31
07161-00.....10	09281-15.....16	09348-02.....21	09829-12.....25	10050-14.....31
07162-00.....10	09281-18.....16	09348-03.....21	09854-11.....26	10050-18.....31
07165-00.....10	09281-20.....16	09348-04.....21	09855-11.....26	10051-14.....31
07167-00.....10	09281-23.....16	09348-05.....21	09962-14.....13	10051-18.....31
07296-00.....6	09282-15.....17	09348-06.....21	09962-17.....13	10061-19.....30
07490-00.....5	09282-18.....17	09349-12.....22	09963-14.....13	10061-19SC...30

10061-19TC...30	10228-18T.....35	11120-1437	11186-1239	11311-1744
10061-23.....30	10228-21.....35	11120-1637	11186-1539	11312-1744
10061-23SC...30	10228-23.....35	11120-1837	11187-1239	11312-1844
10061-23TC...30	10229-11.....35	11120-2037	11187-1841	11313-1744
10201-11.....32	10229-14.....35	11122-1237	11187-2041	11314-0144
10201-11SC...32	10229-18.....35	11122-1337	11187-2541	11314-0244
10202-11.....33	10229-18T...35	11122-1437	11187-3041	11315-0144
10202-14.....33	10229-21.....35	11122-1537	11188-1240	11315-0244
10202-14T.....33	10229-23.....35	11122-1837	11188-12F.....40	11316-1445
10202-18.....33	10230-11.....35	11122-2137	11188-1540	11316-1645
10202-18T.....33	10230-14.....35	11124-1537	11189-1240	11316-2045
10202-21.....33	10230-18.....35	11126-1836	11189-1541	11317-0045
10202-21T.....33	10230-18T...35	11126-2136	11189-2041	11317-1245
10202-23.....33	10230-21.....35	11126-2536	11189-2541	11317-2345
10203-11.....33	10230-23.....35	11130-11.....37	11190-1041	11318-1845
10203-14.....33	11102-1036	11130-1337	11191-1240	11318-2045
10203-14T.....33	11102-11.....36	11130-1437	11220-1741	11318-2545
10203-18.....33	11102-1336	11130-1637	11221-1741	11319-1245
10203-18T.....33	11102-1436	11130-1837	11222-1741	11319-1445
10203-21.....33	11102-1636	11130-2037	11223-1741	11320-1845
10203-21T...33	11102-1836	11132-1637	11224-1741	11320-2345
10203-23.....33	11102-2036	11132-1837	11225-1741	11401-0146
10206-11.....32	11103-1436	11132-2037	11232-1541	11403-0346
10206-11SC...32	11104-1236	11140-11.....37	11246-1842	11403-0446
10207-11.....32	11104-1336	11140-1337	11248-1842	11404-0446
10207-11SC...32	11104-1436	11140-1437	11250-1442	11405-0546
10220-00.....34	11104-1536	11140-1637	11252-2042	11407-0746
10220-00T...34	11104-1836	11140-1837	11256-1542	12090-15D...47
10220-25.....34	11104-2136	11140-2037	11256-2042	12090-18D...47
10220-25T...34	11106-1336	11150-1337	11256-2542	12090-21D...47
10220-45.....34	11106-1536	11150-1437	11257-1542	12090-23D...47
10220-45T...34	11110-1136	11150-1637	11258-1542	12091-15D...47
10220-60.....34	11110-13.....36	11160-1337	11259-1542	12091-18D...47
10220-60T...34	11110-14.....36	11160-1437	11260-1243	12091-21D...47
10220-90.....34	11110-16.....36	11160-1637	11260-1543	12091-23D...47
10220-90T...34	11110-18.....36	11170-1238	11261-1543	12102-1247
10226-11.....35	11110-20.....36	11170-12F...38	11270-1243	12102-12D...47
10226-14.....35	11110-25.....36	11170-1538	11270-1543	12102-2147
10226-18.....35	11112-18.....36	11174-1238	11271-1543	12102-21D...47
10226-18T...35	11112-21.....36	11174-1538	11271-1843	12102-2347
10226-21.....35	11112-25.....36	11176-1238	11272-1543	12102-23D...47
10226-23.....35	11114-14.....36	11176-1538	11273-1543	12103-1247
10227-11.....35	11114-16.....36	11177-1238	11274-0643	12103-12D...47
10227-14.....35	11114-20.....36	11178-1238	11274-0843	12103-1547
10227-18.....35	11114-25.....36	11179-1238	11274-1043	12103-15D...47
10227-18T...35	11116-18.....36	11180-1239	11302-1743	12104-1547
10227-21.....35	11116-21.....36	11180-12F...39	11302-2343	12104-15D...47
10227-23.....35	11116-25.....36	11180-1539	11303-1743	12108-1847
10228-11.....35	11120-1037	11181-1239	11304-1743	12108-18D...47
10228-14.....35	11120-11.....37	11181-1539	11305-1744	12109-1847
10228-18.....35	11120-13.....37	11182-1239	11310-1744	12109-18D...47

12109-21.....47	12308-24.....51	13251-18.....62	19170-50.....66	19230-12.....73
12109-21D.....47	12308-30.....51	13254-14.....62	19170-65.....66	19230-14.....73
12109-23.....47	12309-16.....51	13255-14.....62	19170-76.....66	19230-16.....73
12109-23D.....47	12309-20.....51	13256-14.....61	19180-19.....67	19230-18.....73
12112-15D.....48	12309-24.....51	13257-14.....61	19181-22.....67	19234-00.....73
12112-15T.....48	12309-30.....51	13258-16.....61	19181-25.....67	19237-16.....73
12112-18D.....48	12310-16.....51	13259-16.....61	19183-25.....67	19270-02.....73
12112-18T.....48	12310-20.....51	13260-14.....62	19185-25.....67	19270-03.....73
12112-21D.....48	12310-24.....51	13261-14.....62	19187-25.....67	19270-04.....73
12112-21T.....48	12310-30.....51	13262-16.....62	19188-12.....68	19270-06.....73
12112-23D.....48	13210-10.....59	13263-16.....62	19188-12CL.....68	19271-02.....73
12112-23T.....48	13211-10.....59	13264-16.....62	19210-12.....69	19271-03.....73
12114-15D.....48	13212-10.....59	13265-16.....62	19211-12.....69	19271-04.....73
12114-15T.....48	13213-10.....59	13270-14.....61	19212-01.....69	19271-06.....73
12114-18D.....48	13214-10.....59	13271-14.....61	19212-02.....69	19302-01.....74
12114-18T.....48	13215-10.....59	13310-13.....63	19213-12.....69	19302-02.....74
12114-21D.....48	13220-12.....60	13310-14.....63	19214-13.....70	19302-03.....74
12114-21T.....48	13220-14.....60	13310-16.....63	19214-18.....70	19302-04.....74
12114-23D.....48	13220-18.....60	13311-13.....63	19215-01.....70	19302-05.....74
12114-23T.....48	13220-21.....60	13311-14.....63	19215-02.....70	19302-06.....74
12115-15.....49	13221-12.....60	13311-16.....63	19215-03.....70	19307-01.....74
12115-15T.....49	13221-14.....60	13320-13.....63	19215-13.....70	19307-02.....74
12115-18.....49	13221-18.....60	13320-14.....63	19215-18.....70	19610-07.....75
12115-18T.....49	13221-21.....60	13320-16.....63	19216-01.....70	19611-07.....75
12115-21.....49	13222-12.....60	13321-13.....63	19216-02.....70	19620-07.....75
12115-21T.....49	13223-12.....60	13321-14.....63	19216-05.....70	19620-10.....75
12115-23.....49	13224-12.....60	13321-16.....63	19216-07.....70	19621-07.....75
12115-23T.....49	13225-12.....60	13380-15.....63	19216-10.....70	19621-10.....75
12116-15.....49	13226-12.....60	13381-15.....63	19217-03.....70	19630-10.....75
12116-18.....49	13227-12.....60	13382-15.....63	19217-05.....70	19631-10.....75
12116-21.....49	13230-12.....60	13383-15.....63	19217-07.....70	19634-10.....75
12116-23.....49	13230-14.....60	13410-18.....64	19218-01.....71	19635-10.....75
12117-18.....50	13230-18.....60	13411-18.....64	19218-02.....71	19650-10.....76
12117-21.....50	13230-21.....60	19102-12.....65	19218-11.....71	19651-10.....76
12117-23.....50	13231-12.....60	19102-15.....65	19220-01.....72	19670-14.....76
12118-18.....50	13231-14.....60	19124-15.....65	19220-02.....72	19671-14.....76
12118-21.....50	13231-18.....60	19125-14.....65	19220-03.....72	19741-01.....77
12118-23.....50	13231-21.....60	19127-11.....65	19220-04.....72	19741-02.....77
12302-16.....51	13232-12.....60	19168-06.....66	19221-01.....72	19741-03.....77
12302-20.....51	13233-12.....60	19168-08.....66	19221-02.....72	19741-04.....77
12302-24.....51	13240-14.....61	19168-10.....66	19221-03.....72	19741-05.....77
12304-16.....51	13240-18.....61	19168-12.....66	19221-04.....72	19741-06.....77
12304-20.....51	13241-14.....61	19168-17.....66	19226-02.....72	19741-07.....77
12304-24.....51	13241-18.....61	19168-20.....66	19226-03.....72	19741-08.....77
12304-30.....51	13242-16.....61	19168-25.....66	19226-04.....72	19741-09.....77
12306-16.....51	13243-16.....61	19169-25.....66	19227-02.....72	19741-10.....77
12306-20.....51	13244-14.....61	19170-20.....66	19227-03.....72	19741-11.....77
12306-24.....51	13245-14.....61	19170-25.....66	19227-04.....72	19741-12.....77
12306-30.....51	13250-14.....62	19170-32.....66	19229-02.....72	19741-13.....77
12308-16.....51	13250-18.....62	19170-40.....66	19229-03.....72	19960-01.....78
12308-20.....51	13251-14.....62	19170-45.....66	19230-10.....73	19960-02.....78

19960-03.....78	25180-14.....92	25671-18.....96	33100-02.....98	34556-18.....97
19960-04.....78	25180-16.....92	25672-14.....96	33101-12.....98	41054-20.....85
19960-05.....78	25180-18.....92	25672-14D.....96	33101-14.....98	41056-18.....85
19960-06.....78	25180-20.....92	25672-14T.....96	33201-18.....98	41058-18.....85
19970-01.....79	25184-12.....92	25672-18.....96	33211-15.....98	41068-20.....85
19980-01.....78	25184-14.....92	25672-18D.....96	33213-15.....98	41069-20.....85
19980-02.....78	25184-16.....92	25672-18T.....96	33280-15.....99	41290-21.....107
19980-03.....78	25184-18.....92	25672-21.....96	33281-15.....99	41295-06.....108
19980-04.....78	25184-20.....92	25672-21D.....96	33282-19.....99	41295-07.....108
19980-05.....78	25214-16.....92	25672-21T.....96	33283-17.....99	41295-08.....108
19980-06.....78	25214-18.....92	25672-23.....96	33652-02.....132	41295-09.....108
19980-18.....79	25214-20.....92	25672-23D.....96	33652-03.....132	41295-10.....108
19990-18.....79	25214-23.....92	25673-14.....96	33652-04.....132	41295-11.....108
19991-18.....79	25224-13.....93	25673-14D.....96	33652-05.....132	41295-12.....108
19992-31.....80	25224-15.....93	25673-14T.....96	33652-06.....132	41297-06.....108
19995-22.....79	25224-18.....93	25673-18.....96	33652-08.....132	41297-07.....108
19995-38.....79	25224-20.....93	25673-18D.....96	33652-10.....132	41297-08.....108
19996-04.....81	25225-13.....93	25673-18T.....96	33652-12.....132	41297-09.....108
19997-09.....81	25225-15.....93	25673-21T.....96	33652-15.....132	41297-10.....108
19998-03.....79	25225-18.....93	25674-14.....96	33654-02.....132	41297-11.....108
19998-05.....79	25225-20.....93	25674-18.....96	33654-03.....132	41297-12.....108
19999-00.....82	25230-18.....93	25674-21.....96	33654-04.....132	41299-03.....107
19999-01.....83	25230-20.....93	25675-14.....96	33654-05.....132	41299-05.....107
19999-02.....83	25405-12.....93	25675-18.....96	33654-06.....132	41299-07.....107
19999-03.....83	25406-12.....93	25676-14.....96	33654-08.....132	43150-11.....58
19999-04.....83	25407-12.....93	25677-14.....96	33654-10.....132	43370-12.....86
19999-30.....84	25408-12.....93	25691-18.....96	33654-12.....132	43372-13.....86
19999-30CL...84	25410-14.....93	25700-18.....95	33654-15.....132	43373-13.....86
19999-50.....84	25410-17.....93	25701-18.....95	33686-25.....100	43376-13.....86
19999-50CL...84	25414-14.....93	25720-12.....95	33693-32.....100	43377-13.....86
25110-12.....91	25414-17.....93	25720-12D.....95	33694-01.....100	43378-13.....86
25114-12.....91	25414-18.....93	25720-13.....95	33694-02.....100	43583-07.....4
25128-13.....91	25434-11.....94	25720-13D.....95	33694-03.....100	43583-18.....4
25129-13.....91	25434-13.....94	25720-14.....95	33696-75.....100	43810-10.....52
25130-13.....91	25434-16.....94	25720-14D.....95	33698-98.....100	43811-10.....52
25134-13.....91	25660-12.....95	25730-18.....95	33700-05.....100	43813-10.....52
25136-11.....91	25660-13.....95	25730-18D.....95	33711-16.....101	43820-10.....52
25137-11.....91	25660-14.....95	25730-21.....95	33711-20.....101	43821-10.....52
25140-13.....91	25661-12.....95	25730-21D.....95	33711-21.....101	43823-10.....52
25144-13.....91	25661-13.....95	25730-23.....95	33712-16.....101	43940-05.....53
25150-12.....92	25661-14.....95	25730-23D.....95	33713-17.....101	43940-08.....53
25150-14.....92	25668-18.....96	25731-12.....95	33718-16.....101	43942-05.....53
25154-12.....92	25668-21.....96	25731-13.....95	33719-17.....101	43942-08.....53
25154-14.....92	25668-23.....96	25731-14.....95	33720-19.....102	43950-10.....54
25160-15.....92	25670-14.....96	25731-18.....95	33720-21.....102	43952-10.....54
25160-18.....92	25670-18.....96	25731-18D.....95	34554-15.....97	43953-10.....54
25164-15.....92	25670-21.....96	25731-21.....95	34554-18.....97	44015-20.....55
25164-18.....92	25671-12D.....95	25731-21D.....95	34554-20.....97	44015-27.....55
25164-20.....92	25671-13D.....95	25731-23.....95	34555-15.....97	44076-05.....56
25164-23.....92	25671-14.....96	25731-23D.....95	34555-18.....97	44076-10.....56
25180-12.....92	25671-14D.....95	33100-01.....98	34555-20.....97	44078-05.....56

44078-10.....56	47191-02.....119	47385-15.....125	47473-02.....130	47551-16.....87
44150-01.....55	47191-03.....119	47386-01.....125	47473-03.....130	47551-16L.....87
44150-03.....55	47191-04.....119	47386-02.....125	47474-01.....130	47552-16.....87
44150-05.....55	47192-16.....119	47390-03.....126	47474-02.....130	47553-15.....87
44150-10.....55	47195-01.....119	47390-04.....126	47474-03.....130	47554-01.....88
44150-15.....55	47195-02.....119	47390-05.....126	47475-04.....131	47554-02.....88
44254-09.....55	47197-01.....119	47392-03.....126	47475-06.....131	47554-03.....88
44256-09.....55	47197-02.....119	47392-04.....126	47475-08.....131	47555-08.....88
44258-09.....55	47223-01.....120	47392-05.....126	47481-05.....130	47556-16.....88
44425-10.....55	47223-02.....120	47394-27.....127	47482-05.....132	47557-17.....88
45201-11.....57	47223-03.....120	47410-04.....102	47484-04.....132	47558-15.....88
45206-14.....57	47223-04.....120	47410-05.....102	47484-06.....132	47559-20.....88
45206-16.....57	47223-05.....120	47411-16.....102	47484-08.....132	47560-18.....89
45208-14.....57	47224-01.....120	47414-21.....102	47486-16.....132	47562-18.....89
47102-01.....110	47224-02.....120	47415-18.....102	47487-16.....132	47563-22.....89
47102-02.....110	47224-03.....120	47417-19.....102	47489-16.....132	47564-16.....89
47102-03.....110	47224-04.....120	47419-19.....102	47502-16.....134	47565-10.....57
47103-01.....111	47224-05.....120	47420-01.....103	47504-18.....134	47566-12.....89
47103-02.....111	47225-01.....120	47420-02.....103	47507-17.....134	47567-11.....89
47103-03.....111	47225-02.....120	47420-03.....103	47507-18.....134	47568-08.....89
47112-01.....112	47225-03.....120	47420-04.....103	47511-21.....135	47571-23.....140
47112-02.....112	47225-04.....120	47420-20.....103	47513-21.....135	47572-23.....140
47112-03.....112	47226-01.....120	47421-21.....103	47514-16.....135	47573-23.....140
47116-13.....112	47226-02.....120	47421-23.....103	47516-16.....135	47575-23.....140
47118-13.....112	47226-03.....120	47422-22.....103	47518-21.....135	49115-01.....141
47120-35.....113	47227-01.....120	47423-22.....104	47520-21.....136	49115-02.....141
47120-35S.....114	47227-02.....120	47424-16.....104	47522-01.....137	49117-11.....141
47120-50.....113	47227-03.....120	47425-19.....104	47522-04.....137	49274-09.....141
47120-50S.....114	47237-01.....121	47426-22.....104	47522-05.....137	49274-11.....141
47120-75.....113	47237-02.....121	47428-21.....104	47522-07.....137	49274-13.....141
47120-75S.....114	47239-01.....121	47430-22.....104	47522-09.....137	49274-15.....141
47120-90.....113	47239-02.....121	47450-04.....128	47523-01.....134	49278-01.....105
47120-90S.....114	47242-00.....121	47451-04.....128	47523-02.....134	49278-02.....105
47124-35.....115	47242-01.....121	47454-04.....129	47524-01.....134	49280-18.....105
47124-35S.....116	47251-21.....122	47454-07.....129	47525-20.....134	49281-01.....106
47124-50.....115	47256-20.....122	47454-09.....129	47526-20.....134	49281-02.....106
47124-50S.....116	47323-19.....123	47454-12.....129	47530-00.....138	49310-00.....142
47124-75.....115	47325-19.....123	47455-06.....129	47530-01.....138	49310-01.....142
47124-75S.....116	47347-20.....109	47458-04.....129	47530-02.....138	49310-02.....142
47124-90.....115	47370-16.....124	47458-07.....129	47531-00.....138	49310-03.....142
47124-90S.....116	47371-16.....124	47458-09.....129	47532-19.....138	49310-04.....142
47151-15.....57	47372-16.....124	47458-12.....129	47533-19.....138	49310-05.....142
47151-18.....57	47373-16.....124	47460-04.....129	47534-19.....138	49310-09.....142
47154-20.....57	47374-16.....124	47460-07.....129	47535-01.....139	49310-10.....142
47158-20.....117	47375-16.....124	47460-12.....129	47535-02.....139	49310-11.....142
47159-20.....117	47375-19.....124	47461-00.....133	47538-01.....87	49310-12.....142
47161-16.....117	47376-16.....124	47462-00.....133	47538-02.....87	49315-00.....143
47161-20.....117	47379-16.....125	47463-10.....129	47538-03.....87	49315-01.....143
47169-18.....118	47380-15.....125	47463-12.....129	47538-04.....87	49315-02.....143
47185-18.....118	47382-15.....125	47463-14.....129	47540-16.....87	49315-03.....143
47191-01.....119	47384-15.....125	47473-01.....130	47550-11.....87	49315-10.....143

49317-00.....143	49700-01.....151	R600-040175-030152
49317-01.....143	49700-02.....151	R600-100178-030152
49317-02.....143	55116-1590	R610-040175-001154
49317-03.....143	55117-1790	R610-040175-005155
49317-10.....143	55120-15.....90	R610-040175-070153
49320-00.....144	73193-30.....4	R610-040175-110153
49320-01.....144	93250-15T.....95	R610-040175-115153
49320-02.....144	93250-18T.....95	R631-030160-110156
49320-03.....144	93250-21T.....95	R631-030160-112156
49320-10.....144	93251-15T.....95	R631-030160-116156
49320-20.....144	93251-18T.....95	R631-030160-212157
49340-00.....144	93251-21T.....95	R631-030160-224157
49342-01.....145	93260-15T.....95	R631-030160-246157
49342-02.....145	93260-18T.....95	R660-050340-002158
49342-03.....145	93260-21T.....95	R660-050340-004158
49342-04.....145	93261-15T.....95	R661-050340-002158
49342-05.....145	93261-18T.....95	R661-050340-004158
49605-07.....146	93261-21T.....95	
49605-10.....146	93385-21.....12	
49605-11.....146	93385-25.....12	
49605-12.....146	93390-21.....12	
49605-14.....146		
49605-16.....146		
49610-12.....147		
49610-13.....147		
49610-16.....147		
49613-10.....148		
49615-12.....148		
49620-15.....148		
49623-16.....148		
49627-01.....148		
49630-02.....148		
49635-18.....149		
49640-05.....149		
49640-07.....149		
49640-09.....149		
49650-06.....149		
49650-07.....149		
49650-09.....149		
49650-11.....149		
49660-18.....150		
49666-10.....151		
49666-15.....151		
49666-20.....151		
49667-10.....151		
49667-15.....151		
49680-10.....150		
49680-20.....150		
49685-21.....150		
49691-15.....150		
49692-15.....150		

A	Blepharoplastik Schere,	COTTLE, Stahlhammer100
ADSON, Arterienklemme64	GREENBERG-PAR32	COTTLE-JOSEPH, Septumelevatör ..103
ADSON, Durahaken85	Blepharoplastik Schere, KAYE32	COTTLE-KAZANJIAN,
ADSON, Pinzette38,39	BÖHLER, Hohlmeißelzange98	Knochensplitterzange99
ADSON, Saugrohr107	BÖHLER, Knochensplitterzange ...99	COTTLE-MASING, Nasenschere ..27
ADSON-BROWN, Pinzette40	BOIES, Elevator.....102	COTTLE-NEIVERT, Hauthäkchen ..88
AGRIS-DINGMAN, Brustdissektor..82	BONN, Schere20	CRILE, Arterienklemme62
ALM, Wundhaken75	BONNEY, Pinzette45	CRILE, Nervhaken.....85
Anatomische Pinzette36	BREAST, Wundhaken.....79	CRILE, Wundhaken65
ANDERSON, Hauthäkchen79	BROWN, Pinzette41	CRILE-RANKIN, Arterienklemme ..62
ANDREW, Zungenspatel141	BRUENINGS, Septumzange119	CRILE-WOOD, Nadelhalter92
Antrumraspel, WIENER134	Brustdissektor, AGRIS-DINGMAN ..82	CRIONIN, Gaumenspalt-Messer ..105
Arterienklemme, ROCHESTER-PEAN..63	Brustdissektor, SILVERSTEIN83	CUSHING (TAYLOR), Pinzette44
Arterienklemme, ADSON64	Brustdissektor, TEBBETTS83	CUSHING, Pinzette.....41
Arterienklemme, COLLER-CRILE ..61	Brustdissektor,	CUSHING, Nervenhaken85
Arterienklemme, CRILE62	MacCOLLUM-DINGMAN83	
Arterienklemme, CRILE-RANKIN ..62	Brustspatel80	D
Arterienklemme, HALSTED-MOSQUITO ..60	Bügel, McIVOR144	Darmspatel, RIBBON.....66
Arterienklemme, HARTMANN59		D'ASSUMPACO,
Arterienklemme, JACOBSON Micro ..60	C	Markierungsinstrument3
Arterienklemme, KELLY61	CAPLAN, Nasenzange122	DAVIS-BOYLE, Mundsperrer.....142
Arterienklemme, KELLY-RANKIN ..61	CASTROVIEJO, Meßinstrument4	DAVIS-BOYLE, Zungenspatel142
Arterienklemme, LERICHE63	CASTROVIEJO, Meßzirkel.....4	DAVIS-MEYER, Mundsperrer144
Arterienklemme,	CASTROVIEJO, Mikro-Nadelhalter ...96	DeBAKEY, Nadelhalter92
PROVIDENCE-HOSPITAL61	CASTROVIEJO, Nahtpinzette55	DEAVER, Wundhaken67
Arterienklemme,	CHADWICK, Zahnfleissschere26	DeBAKEY, Atrauma Pinzette ..49,50,51
ROCHESTER-OCHSNER63	Chalazionspinzette, DESMARRES ...55	Delphinzange für plastische
ASCH, Septumrichtzange.....140	Chirurgische Pinzette.....37	Endoskopie157
Atrauma Pinzette, DeBAKEY ..47,48,51	Cilienpinzette, BARRAQUER55	DERF, Nadelhalter91
AUFRICHT, Nasenhaken.....87	COLLER-CRILE, Arterienklemme..61	Dermatom, HUMBY6
AUFRICHT, Nasenraspel.....135	COLLIER, Beckenzirkel4	Dermatom, SCHINK5
	COLLIN-DUVAL, Faßpinzette42	Dermatom, SILVER6
	Columella-Pinzette, COTTLE57	Dermatom, WATSON.....6
B	CONVERSE, Nasenhaken87,89	DESMARRES, Chalazionspinzette ...55
BABY OLSEN-HEGAR, Nadelhalter ..93	CONVERSE, Nasenmesser125	DESMARRES, Wundhaken.....73
BABY WEBSTER, Nadelhalter91	CONVERSE/WILMER/WALTER,	DINGMANN, Nasenraspel138
BALLENGER, Schwingmesser.....126	Schere22	DINGMANN, Elevator150
BALLENGER, Septumelevatör104	CORONAL, Wundhaken79	DINGMANN, Mundsperrer.....143
BARON, Saugrohr107	COTTLE, Columella-Pinzette57	DINGMANN, Raspator.....150
BARRAQUER, Cilienpinzette55	COTTLE, Fixierpinzette57	DINGMANN, Sperrer143
BARRAQUER, Nadelhalter95	COTTLE, Hauthäkchen88,89	DINGMANN, Zungenspatel143
BARSKY, Hauthäkchen71	COTTLE, Knorpelquetscher133	Dissektor, GORNEY102
BAUMGARTNER, Nadelhalter92	COTTLE, Nasenhaken87	Drahtbürste138
BEASELEY BABCOCK, Pinzette ...39	COTTLE, Nasenmesser125	Drahtzange TC, BERRY97
Beckenzirkel, COLLIER4	COTTLE, Nasenschere27	Drahtzange TC,
BERKE, Muskelpinzette.....55	COTTLE, Nasenspekula115,116	MAYO-HABERISSER97
BERRY, TC-Drahtzange97	COTTLE, Osteotom.....129	Durahaken, ADSON.....85
BEUSE, Face-Lift-Schere31	COTTLE, Schere22	DURANTE, Faßpinzette45
BEYER, Hohlmeißelzange.....98	COTTLE, Septumelevatör103,104	DUVAL, Faßpinzette42
BIGGS, Wundhaken84	COTTLE, Septummeißel129	
BISHOP-HARMAN, Irispinzette53	COTTLE, Septumosteotom129	
BLAIR, Gaumenspalt-Elevatör.....106		

E	FOMON, Nasenraspel	136	HALSTED-MOSQUITO,	
Elevator, BALLENGER	FOMON, Nasenschere	27	Arterienklemme	60
Elevator, BOIES	FOMON, Raspator	101	Hammer	100
Elevator, COTTLE-JOSEPH ..	FRAZIER, Hauthäkchen	70	Hammer, COTTLE	100
Elevator, DINGMANN	FRAZIER/FERGUSON, Saugrohr ..	108	Hammer, GERZOG	100
Elevator, FREER	FREEMAN, Markierungsinstrument ..	4	Hammer, MEAD	100
Elevator, HAJEK-BALLENGER ..	FREEMAN, Wundhaken	68,79,81	Hammer, PARTSCH	100
Elevator, HOWARTH	FREER, Hauthäkchen	88	Hammer, QUISLING	100
Elevator, JOSEPH	FREER, Mukosamesser	124	HARTMANN, Arterienklemme	59
Elevator, KILLIAN	FREER, Septumelevator	102	HARTMANN, Nasenspekula	111
Elevator, MASING	FREER, Septumhohlmeißel	132	HARTMANN, Polypenzange	117
Elevator, McKENTY	FREER, Septummeißel	128	HARTMANN-HALLE,	
Elevator, OBWEGESER	FRIEDMANN, Hohlmeißelzange ..	98	Nasenspekula	110
Elevator, PENNINGTON			Hauthäkchen, FRAZIER	70
Elevator, PIERCE	G		Hauthäkchen, ANDERSON	79
Elevator, SINUS	Gaumenspalt-Elevator, BLAIR	106	Hauthäkchen, BARSKY	71
Endo-Dissektor, LANGENBECK ..	Gaumenspalt-Messer, CRIONIN ..	105	Hauthäkchen, COTTLE	88,89
Endo-Dissektor,	Gaumenspalter, Raspatorium	105	Hauthäkchen, COTTLE-NEIVERT ..	88
MINI-LANGENBECK	Gefäßspinzette, STILLE-BARRAYA ..	45	Hauthäkchen, FOMON	88
Endo-Dissektor	GERALD, Pinzette	43,44	Hauthäkchen, FREER	88
Endoskop	GERZOG, Hammer	100	Hauthäkchen, GILLIES	89
Ersatzbacken f. Hammer	Gewebefäßspinzette, SINGLEY	45	Hauthäkchen, GRAEFE	69
Ersatzklinge f. SCHINK Dermatome ..	GILLIES, Hauthäkchen	89	Hauthäkchen, GUTHRIE	69
Ersatzklingen f. Dermatomy	GILLIES, Nadelhalter	94	Hauthäkchen, HUMBY	71
	GILLIES, Pinzetten	43	Hauthäkchen, JOSEPH	70
F	GLABELLA, Nasenraspel	134	Hauthäkchen, KLEINERT-KUTZ ..	70
Face-Lift-Schere, BEUSE	GOLDMAN-FOX, Zahnfleissschere ..	29	Hauthäkchen, REDA	72
Face-Lift-Schere, GORNEY	Goniometer, Finger	2	Hauthäkchen, TYRELL	69
Face-Lift-Schere,	GORNEY, Dissektor	102	HEYMANN, Nasenschere	27
GORNEY-FREEMAN	GORNEY, Face-Lift-Schere	30	HEYMANN-KNIGHT, Polypenzange ..	118
Face-Lift-Schere, KAYE	GORNEY, Wundhaken	81	Hohlmeißel, FREER	132
Face-Lift-Schere, PECK-JOSEPH ..	GORNEY-FREEMAN,		Hohlmeißel, HAJEK	132
Fadenpinzette, OCHSNER	Face-Lift-Schere	30	Hohlmeißel, KILLIAN	130
Fadenschere, LITTAUER	GRADLE, Schere	23	Hohlmeißel, KILLIAN-CLAUS	132
Fadenschere, O'BRIEN	GRAEFE, Hauthäkchen	69	Hohlmeißel, WEST	132
Fadenschere, SPENCER	GRAEFE, Irispinzette	52	Hohlmeißelzange, BEYER	98
FARABEUF, Wundhaken	GRAEFE, Pinzette	41	Hohlmeißelzange, BÖHLER	98
Faßpinzette, COLLIN-DUVAL	GRAEFE, Schere	22	Hohlmeißelzange, FRIEDMANN ..	98
Faßpinzette, DURANTE	GRAIG, Septumzange	119	HOLZHEIMER, Wundsperrer	75
Faßpinzette, DUVAL	GREEN, Fixierpinzette	56	HOWARTH, Septumelevator	103
Faßpinzette, RUSS. MODELL	GREENBERG-PAR,		HUMBY, Dermatome	6
Faßzange f. plastische Endoskopie ..	Blepharoplastik Schere	32	HUMBY, Hauthäkchen	71
Faßzange, MARYLAND	GUILEN, Saugraspatorium	109		
FERRIERA, Wundhaken	GUTHRIE, Hauthäkchen	69	I	
FERRIS-SMITH, Pinzette			IRIS, Schere	20
Finger-Goniometer	H		Irishäkchen, O'CONNOR	86
FINSEN, Wundhaken	HAJEK, Septumhohlmeißel	132	Irishäkchen, WIENER	86
Fixierpinzette, COTTLE	HAJEK-BALLENGER,		Irispinzette, BISHOP-HARMAN	53
Fixierpinzette, GREEN	Septumelevator	104	Irispinzette, GRAEFE	52
Flachmeißel, MINI-LAMBOTTE ..	Hakenschere für plastische			
FOERSTER, Kapselmesser	Endoskopie	156		
FOMON, Hauthäkchen	HALSEY, Nadelhalter	91		

J	L	MEAD, Hammer.....100
JACKSON, Trachealhaken90	LA GRANGE, Zahnfleischschere...26	Meißel, COTTLE.....129
JACOBSON Mikro, Arterienklemme ..60	LAHEY, Wundhäkchen70	Meißel, FREER.....128
JAEGER, Lidplatte.....58	LANDOLT, Skalpellgriff12	Meißel, KILLIAN.....130
JAMESON, Präparierschere.....19	LANGE, Nasenflügelhäkchen89	Meißel, MINI-LAMBOTTE.....132
JANSEN, Wundsperrerr.....75	LANGENBECK, Endo-Dissektor ...77	Meißel, SILVER130
JANSEN-GRUENWALD, Ohrpinzette57	LANGENBECK, Raspator.....101	Meßinstrument, CASTROVIEJO4
JENNINGS, Mundsperrerr.....141	LERCHE, Pinzette41	Meßinstrument, COLLIER4
J-Haken Elektrode, monopolar158	LERICHE, Arterienklemme63	Meßzirkel, CASTROVIEJO.....4
JOSEPH (LEWIS), Nasenraspel...135	LEXER, Präparierschere15	Metallmaßstab2
JOSEPH, Hauthäkchen70	LEXER BABY, Präparierschere15	METZENBAUM, Präparierschere ..16,17
JOSEPH, Nasenmesser124,125	Lidplatte, JAEGER.....58	METZENBAUM, Schere für plastische Endoskopie.....156
JOSEPH, Nasenraspel134	LITTAUER, Fadenschere.....28	METZENBAUM-FINO, Präparierschere17
JOSEPH, Nasensäge138,139	LITTLER, Schere22	MEYERDING, Wundhaken74
JOSEPH, Präparierschere.....18	LOCKWOOD, Markierungsinstrument .3	Micro HARTMANN, Arterienklemme...59
JOSEPH, Raspator.....101	LUBET-BARBON, Nasentamponzange.....117	MICROVASCULAR, Nadelhalter93
JOSEPH, Septumelevator102	LUC, Septumzange.....119	MIDDLETON-JANSEN, Septumzange.....123
JOST, Knorpelquetscher.....133	LUCAE, Ohrpinzette57	Mikro Knüpfpinzette47
	MacCOLLUM-DINGMAN, Brustdissektor83	Mikro Ringpinzetten48
K	M	Mikro Nadelhalter, CASTROVIEJO ...96
Kapselmesser, FOERSTER.....127	MALINIAC, Nasenhaken87	Mikro Pinzette43
KASDEN, Wundhaken.....73	MALTZ (COTTLE), Nasenraspel ..135	Mikro Schere.....33,34,35
KAYE, Blepharoplastik-Schere32	MALTZ, Nasenraspel134	MILLER, Wundhäkchen86
KAYE, Face-Lift-Schere.....31	Markierungsinstrument, D'ASSUMPACO.....3	MINI, Skalpellgriff.....10
KELLY, Arterienklemme61	Markierungsinstrument, FREEMAN.....4	MINI, Skalpellklingen10
KELLY, Präparierschere.....19	Markierungsinstrument, LOCKWOOD .3	MINI-LAMBOTTE, Flachmeißel....132
KELLY-RANKIN, Arterieklemme61	Markierungsinstrument, McKISSOCK.....4	MINI-LANGENBECK, Endo-Dissektor77
KILLIAN, Hohlmeißel130	Markierungsinstrument, PITANGUY....3	Mobilisierhaken, TESSIER150
KILLIAN, Nasenspekula113,114	MARTINEZ-KILNER, Wundhaken ..89	MOD. BONN, Nahtpinzette.....54
KILLIAN, Septumelevator103,104	MARYLAND, Faßzange für plastische Endoskopie.....157	MOD.TUEBINGEN, Nahtpinzette..54
KILLIAN-CLAUS, Septumhohlmeißel.132	MASING, Elevator.....102	MOD. WIEN, Nasenspekula112
KILNER, Nasenhaken.....88	MASING-NEIVERT, Nasenhaken...87	MOELTGEN, Winkelmesser2
KILNER, Präparierschere19	Maßstab, Metall2	Monopolare J-Haken-Elektrode....158
KILNER-DOUGHTY, Mundsperrerr...143	MAYO, Präparierschere13	Monopolare Spatel-Elektrode158
KILNER-DOUGHTY, Zungenspatel .143	MAYO-HABERISSER, TC-Drahtzange97	Mukosamesser, FREER124
KLAPP, Wundhaken72	MAYO-HEGAR, Nadelhalter92	Mundsperrerr, DAVIS-BOYLE.....142
KLEINERT-KUTZ, Hauthäkchen.....70	MAYO-STILLE, Präparierschere....14	Mundsperrerr, DAVIS-MEYER.....144
KNAPP, Schere.....21	McINDOE, Knochensplitterzange ..99	Mundsperrerr, DINGMANN.....143
KNAPP, Tränensackhäkchen.....86	McINDOE, Knorpelschere29	Mundsperrerr, JENNINGS141
KNIGHT, Septumzange.....118	McINDOE, Pinzetten.....42	Mundsperrerr, KILNER-DOUGHTY ...143
Knochensplitterzange, BÖHLER...99	McIVOR, Mundsperrerr.....144	Mundsperrerr, McIVOR.....144
Knochensplitterzange, COTTLE-KAZANJIAN.....99	McIVOR, Bügel.....144	Muskelpinzette, BERKE.....55
Knorpelquetscher, COTTLE.....133	McIVOR, Zungenspatel144	MYLES, Nasenzange121
Knorpelquetscher, JOST.....133	McKENTY, Septumelevator...102,103	
Knorpelschere, McINDOE29	McKISSOCK, Markierungsinstrument .4	
Knüpfpinzette, Mikro47		

N	Nasentamponzange,	Pinzette, BERKE.....	55		
Nadelhalter, BABY OLSEN-HEGAR...93	LUBET-BARBON.....	117	Pinzette, BISHOP-HARMAN.....	53	
Nadelhalter, BABY WEBSTER.....91	Nasentamponzange,	WESTMACOTT.....	117	Pinzette, BONNEY.....	45
Nadelhalter, BARRAQUER.....95	Nasenzange, CAPLAN.....	122	Pinzette, BROWN.....	41	
Nadelhalter, BAUMGARTNER.....92	Nasenzange, MYLES.....	121	Pinzette, CASTROVIEJO.....	55	
Nadelhalter, CRILE-WOOD.....92	Nasenzange, SCHMEDEN.....	121	Pinzette, chirurgisch.....	37	
Nadelhalter, DeBAKEY.....92	Nasenzange, TAKAHASHI.....	121	Pinzette, COLLIN-DUVAL.....	42	
Nadelhalter, DERF.....91	Nasenzange, WEIL-BLAKESLEY.....	120	Pinzette, COTTLE.....	57	
Nadelhalter, GILLIES.....94	NEIVERT-ANDERSON, Osteotom.....	130	Pinzette, CUSHING.....	41	
Nadelhalter, HALSEY.....91	Nervhaken.....	77	Pinzette, DeBAKEY.....	48,50,51	
Nadelhalter, MAYO-HEGAR.....92	Nervhaken, CRILE.....	85	Pinzette, DESMARRES.....	55	
Nadelhalter, MICROVASCULAR...93	Nervhaken, CUSHING.....	85	Pinzette, DURANTE.....	45	
Nadelhalter, Mikro, Titan.....95	NEWS, Trachealhaken.....	90	Pinzette, DUVAL.....	42	
Nadelhalter, OLSEN-HEGAR.....93	O	O'BRIEN, Fadenschere.....	28	Pinzette, FERRIS-SMITH.....	42
Nadelhalter, RYDER.....93	O'BRIEN, Fadenschere.....	28	Pinzette, GERALD.....	43,44	
Nadelhalter, WEBSTER.....91	OBWEGESER, Osteotom.....	131	Pinzette, GILLIES.....	43	
Nahtpinzette, CASTROVIEJO.....	OBWEGESER, Raspator.....	149	Pinzette, GRAEFE.....	41,52	
Nahtpinzette, MOD. BONN.....	OBWEGESER, Wundhaken	146,147,148	Pinzette, GREEN.....	56	
Nahtpinzette, MOD. TUEBINGEN..54	OCHSNER, Fadenpinzette.....	45	Pinzette, JANSEN-GRUENWALD..57	Pinzette, LERCHE.....	41
Nasenflügelhäkchen, LANGE.....	O'CONNOR, Irishäkchen.....	86	Pinzette, LUCAE.....	57	
Nasenhaken, AUFRICHT.....	OEHLER, chirurgische Pinzette.....	37	Pinzette, LUCAE.....	57	
Nasenhaken, CONVERSE.....	Ohrpinzette, JANSEN-GRUENWALD..57	Ohrpinzette, LUCAE.....	57	Pinzette, McINDOE.....	42
Nasenhaken, COTTLE.....	Ohrpinzette, TROELTSCH.....	57	Pinzette, MOD. BONN.....	54	
Nasenhaken, KILNER.....	Ohrpinzette, WILDE (TROELTSCH)...57	OLSEN-HEGAR, Nadelhalter.....	93	Pinzette, MOD. TUEBINGEN.....	54
Nasenhaken, MALINIAC.....	Opthalmologie Schere.....	23	Pinzette, OCHSNER.....	45	
Nasenhaken, MASING-NEIVERT..87	Optik f. plastische Endoskopie.....	152	Pinzette, OEHLER.....	37	
Nasenmesser, CONVERSE.....	Osteotom.....	151	Pinzette, POTTS-SMITH.....	36	
Nasenmesser, COTTLE.....	Osteotom, COTTLE.....	129	Pinzette, RUSSE MODELL.....	42	
Nasenmesser, JOSEPH.....	Osteotom, NEIVERT-ANDERSON...130	Osteotom, OBWEGESER.....	131	Pinzette, SEMKEN.....	43
Nasenraspel, AUFRICHT.....	Osteotom, RUBIN.....	129	Pinzette, SINGLEY.....	45	
Nasenraspel, DINGMAN.....	Osteotom, TESSIER.....	151	Pinzette, STILLE.....	36,37	
Nasenraspel, FOMON.....	Osteotom, WEST.....	132	Pinzette, STILLE-BARRAYA.....	45	
Nasenraspel, GLABELLA.....	P	PARKES, Nasenraspel.....	134	Pinzette, TAYLOR.....	44
Nasenraspel, JOSEPH.....	PARKES, Nasenraspel.....	134	Pinzette, TROELTSCH.....	57	
Nasenraspel, JOSEPH (LEWIS)..135	PARTSCH, Hammer.....	100	Pinzette, USA.....	36,37	
Nasenraspel, MALTZ.....	PECK-JOSEPH, Face-Lift-Schere..31	PEET, Nasenraspel.....	134	Pinzette, WAUGH.....	41
Nasenraspel, MALTZ (COTTLE)..135	PEET, Nasenraspel.....	134	Pinzette, WILDE (TROELTSCH)....57	PITANGUY, Markierungsinstrument...3	
Nasenraspel, PARKES.....	PENNINGTON, Septumelevator...103	PIERCE, Septumelevator.....	103	Polypenzange, HARTMANN.....	117
Nasenraspel, PEET.....	Pinzette, CUSHING (TAYLOR)....44	Pinzette, ADSON.....	38,39	Polypenzange, HEYMANN-KNIGHT 118	
Nasensäge, JOSEPH.....	Pinzette, ADSON-BROWN.....	40	POTTS-SMITH, Pinzette.....	36	
Nasenschere, COTTLE.....	Pinzette, anatomisch.....	36	Präparierschere, JAMESON.....	19	
Nasenschere, COTTLE-MASING..27	Pinzette, BARRAQUER.....	55	Präparierschere, JOSEPH.....	18	
Nasenschere, FOMON.....	Pinzette, BEASELEY BABCOCK...39		Präparierschere, KELLY.....	19	
Nasenschere, HEYMANN.....			Präparierschere, KILNER.....	19	
Nasenspekula, HARTMANN-HALLE..110			Präparierschere, LEXER.....	15	
Nasenspekula, COTTLE.....			Präparierschere, LEXER BABY.....	15	
Nasenspekula, HARTMANN.....			Präparierschere, MAYO.....	13	
Nasenspekula, KILLIAN.....			Präparierschere, MAYO-STILLE....14	Präparierschere, METZENBAUM	
Nasenspekula, Mod. WIEN.....			16,17	
Nasenspekula, REDA.....					
Nasenspekula, TIECK-HALLE.....					

Präparierschere,
 METZENBAUM FINO17
 Präparierschere, RAGNELL19
 Präparierschere, REYNOLDS19
 Präparierschere, SANVENERO18
 PROVIDENCE-HOSPITAL,
 Arterienklemme61

Q
 QUISLING, Hammer100

R
 RAGNELL, Präparierschere19
 RAGNELL, Wundhaken65
 RAMUS, Wundhaken148
 Rasierklingen, unsteril6
 Raspator, DINGMANN150
 Raspator, FOMON101
 Raspator, JOSEPH101
 Raspator, LANGENBECK101
 Raspator, OBWEGESER149
 Raspator, WILLIGER101
 Raspatorium, Gaumenspalter105
 Rospel, AUFRICHT135
 Rospel, DINGMAN138
 Rospel, FOMON136,137
 Rospel, JOSEPH (LEWIS)135
 Rospel, MALTZ (COTTLE)135
 Rospel, PARKES134
 Rospel, PEET134
 Rospel, WIENER134
 REDA, Hauthäkchen72
 REDA, Nasenspekula112
 REDA, Sichelmesser125
 REYNOLDS, Präparierschere19
 RIBBON, Darmspatel66
 Ringpinzette, Mikro49
 ROCHESTER-OCHSNER,
 Arterienklemme63
 ROCHESTER-PEAN,
 Arterienklemme63
 ROLLET, Tränensackhäkchen86
 ROUX MINI, Wundhaken65
 RUBIN, Osteotom129
 RUBIN, Septumzange122
 RUSS, MODELL, Faßpinzette42
 RUSSEL-DAVIS, Zungenspatel145
 RYDER, Nadelhalter93

S
 SANVENERO, Präparierschere18
 Saugraspatorium, GUILLEN109
 Saugrohr, ADSON107
 Saugrohr, FRAZIER/FERGUSSON108
 Saugrohr, BARON107
 Schaft f. plastische Endoskopie
153,154,155
 Schere f. plastische Endoskopie156
 Schere, BEUSE31
 Schere, BONN20
 Schere, CHADWICK26
 Schere, CONVERSE/WILMER22
 Schere, COTTLE22,27
 Schere, COTTLE-MASING27
 Schere, FOMON27
 Schere, GOLDMAN-FOX29
 Schere, GORNEY30
 Schere, GORNEY-FREEMAN30
 Schere, GRADLE23
 Schere, GRAEFE22
 Schere, GREENBERG-PAR32
 Schere, HEYMANN27
 Schere, IRIS20
 Schere, JAMESON19
 Schere, JOSEPH18
 Schere, KAYE31,32
 Schere, KELLY19
 Schere, KILNER19
 Schere, KNAPP21
 Schere, LA GRANGE26
 Schere, LEXER15
 Schere, LEXER BABY15
 Schere, LITTAUER28
 Schere, LITTLER22
 Schere, MAYO13
 Schere, MAYO-STILLE14
 Schere, McINDOE29
 Schere, METZENBAUM16,17
 Schere, METZENBAUM-FINO17
 Schere, Mikro33,34,35
 Schere, O'BRIEN28
 Schere, Ophtalmologie23
 Schere, PECK-JOSEPH31
 Schere, RAGNELL19
 Schere, REYNOLDS19
 Schere, SANVENERO18
 Schere, SPENCER28
 Schere, STEVENS24
 Schere, STRABISMUS24
 Schere, WAGNER25
 SCHINK, Dermatome5

SCHMEDEN, Nasenzange121
 Schwingmesser, BALLENGER126
 SEMKEN, Pinzetten43
 Septumelelevator, BALLENGER104
 Septumelelevator, COTTLE103,104
 Septumelelevator,
 COTTLE-JOSEPH103
 Septumelelevator, FREER102
 Septumelelevator,
 HAJEK-BALLENGER104
 Septumelelevator, HOWARTH103
 Septumelelevator, JOSEPH102
 Septumelelevator, KILLIAN103,104
 Septumelelevator, McKENTY102,103
 Septumelelevator, PENNINGTON103
 Septumelelevator, PIERCE103
 Septumelelevator, SINUS103
 Septumhohlmeißel, FREER132
 Septumhohlmeißel, HAJEK132
 Septumhohlmeißel,
 KILLIAN-CLAUS132
 Septummeißel, COTTLE129
 Septummeißel, FREER128
 Septummeißel, SILVER130
 Septumosteotom, COTTLE129
 Septumrichtzange, ASCH140
 Septumrichtzange, WALSHAM140
 Septumzange, BRUENINGS119
 Septumzange, GRAIG119
 Septumzange, KNIGHT118
 Septumzange, LUC119
 Septumzange,
 MIDDLETON-JANSEN123
 Septumzange, RUBIN122
 Sichelmesser, REDA125
 Silikon-Schlauch144
 SILVER, Dermatome6
 SILVER, Septummeißel130
 SILVERSTEIN, Brustdissektor83
 SINGLEY, Gewebefaßpinzette45
 SINUS, Septumelelevator103
 Skalpellgriff, LANDOLT12
 Skalpellgriff, Mini10
 Skalpellklingen, Mini10
 Skalpellklingen, steril11
 Skalpellklingen-Entferner11
 Spannplatte5
 Spatel80
 Spatel-Elektrode, monopolar158
 SPENCER, Fadenschere28
 Sperrer, DAVIS-BOYLE142
 Sperrer, DINGMANN143

Sperrer, KILNER-DOUGHTY.....	143	W	Wundhaken, MEYERDING.....	74
SPINA-NASALIS, Wundhaken.....	148	WAGNER, Schere.....	Wundhaken, OBWEGESER	
Splitterpinzetten.....	46	WALSHAM, Septumrichtzange.....	146, 147, 148	
Stahlhammer, COTTLE.....	100	WALTER/CONVERSE/WILMER,	Wundhaken, RAGNELL.....	65
STEVENS, Schere.....	24	Schere.....	Wundhaken, RAMUS.....	148
STILLE, Pinzette.....	36, 37	WATSON, Dermatom.....	Wundhaken, ROUX MINI.....	65
STILLE-BARRAYA, Gefäßpinzette.....	45	WAUGH, Pinzette.....	Wundhaken, SPINA-NASALIS.....	148
STRABISMUS, Schere.....	24	WEBSTER, Nadelhalter.....	Wundhaken, STRANDELL-STILLE.....	74
STRANDELL-STILLE, Wundhaken.....	74	WEIL-BLAKESLEY, Nasenzange.....	Wundhaken, TEBBETTS.....	78
T		WEITLANER, Wundsprerrer.....	Wundhaken, VOLKMANN.....	73
TAKAHASHI, Nasenzange.....	121	WEST, Hohlmeißel.....	Wundhaken, YANKOSKIE.....	79
Tamponzange, LUBET-BARBON.....	117	WEST, Osteotom.....	Wundsperrer, HOLZHEIMER.....	75
Tamponzange, WESTMACOTT.....	117	WESTMACOTT,	Wundsprerrer, WEITLANER.....	76
TAYLOR, Pinzette.....	44	Nasentamponzange.....	Wundsprerrer, JANSEN.....	75
TC-Drahtzange, BERRY.....	97	WIEDER, Zungenspatel.....		
TC-Drahtzange,		WIENER, Antrumraspel.....	Y	
MAYO-HABERISSER.....	97	WIENER, Irishäkchen.....	YANKOSKIE, Wundhaken.....	79
TC-Nasenraspel, FOMON.....	137	WILDE (TROELTSCH), Ohrpinzette.....		
TC-Nasenraspel, MALTZ (COTTLE).....	135	WILLIGER, Raspator.....	Z	
TEBBETTS, Brustdissektor.....	83	WILMER/CONVERSE/WALTER,	Zahnfleischschere, CHADWICK.....	26
TEBBETTS, Wundhaken.....	78	Schere.....	Zahnfleischschere,	
TESSIER, Mobilisierhaken.....	150	Winkelmesser, MOELTGEN.....	GOLDMAN-FOX.....	29
TESSIER, Osteotom.....	151	Wundhäkchen, BARSKY.....	Zahnfleischschere, LA GRANGE.....	26
TIECK-HALLE, Nasenspekula.....	112	Wundhäkchen, COTTLE.....	Zungenspatel, ANDREW.....	141
Titan Mikro Nadelhalter.....	95, 96	Wundhäkchen, COTTLE-NEIVERT.....	Zungenspatel, DAVIS-BOYLE.....	142
Trachealhaken, JACKSON.....	90	Wundhäkchen, FOMON.....	Zungenspatel, DINGMANN.....	143
Trachealhaken, NEWS.....	90	Wundhäkchen, FREER.....	Zungenspatel,	
Tränensackhäkchen, KNAPP.....	86	Wundhäkchen, GILLIES.....	KILNER-DOUGHTY.....	143
Tränensackhäkchen, ROLLET.....	86	Wundhäkchen, HUMBY.....	Zungenspatel, McIVOR.....	144
TROELTSCH, Ohrpinzette.....	57	Wundhäkchen, KNAPP.....	Zungenspatel, RUSSEL-DAVIS.....	145
TYRELL, Hauthäkchen.....	69	Wundhäkchen, LAHEY.....	Zungenspatel, WIEDER.....	141
		Wundhäkchen, MILLER.....		
U		Wundhäkchen, O'CONNOR.....		
Uhrmacherpinzette.....	46	Wundhäkchen, ROLLET.....		
USA, Pinzette.....	36, 37	Wundhäkchen, ROLLET.....		
		Wundhäkchen, WIENER.....		
V		Wundhaken.....		
VOLKMANN, Wundhaken.....	73	Wundhaken, ALM.....		
		Wundhaken, ANDERSON.....		
		Wundhaken, BIGGS.....		
		Wundhaken, BREAST.....		
		Wundhaken, CORONAL.....		
		Wundhaken, CRILE.....		
		Wundhaken, DEEVER.....		
		Wundhaken, DESMARRES.....		
		Wundhaken, FARABEUF.....		
		Wundhaken, FERRIERA.....		
		Wundhaken, FINSEN.....		
		Wundhaken, FREEMAN.....		
		Wundhaken, GORNEY.....		
		Wundhaken, KASDEN.....		
		Wundhaken, KLAPP.....		
		Wundhaken, MARTINEZ-KILNER.....		

- A**
- ADSON, dressing forceps.....38
- ADSON, tissue forceps.....38, 39
- ADSON, forceps.....64
- ADSON, hook.....85
- ADSON, suction tube.....107
- ADSON-BROWN, tissue forceps....40
- ADSON-DeBAKEY, dressing forceps....38
- AGRIS-DINGMAN, dissector.....82
- ALM, retractor.....75
- ANDERSON, retractor.....79
- ANDREW, tongue depressor.....141
- ASCH, septum straightening
forceps.....140
- atrauma forceps, DeBAKEY...49, 50, 51
- AUFRICHT, retractor.....87
- AUFRICHT, nasal rasp.....135
- B**
- BABY OLSEN-HEGAR,
needle holder.....93
- BALLENGER, elevator.....104
- BALLENGER, knife.....126
- BARON, suction tube.....107
- BARRAQUER, cilia forceps.....55
- BARRAQUER, needle holder.....95
- BARSKY, retractor.....71
- BAUMGARTNER, needle holder....92
- BEASELEY BABCOCK,
tissue forceps.....39
- BERKE, muscle forceps.....55
- BERRY, wire twisting forceps.....97
- BEUSE, scissors.....31
- BEYER, rongeur.....98
- BIGGS, retractor.....84
- BISHOP-HARMAN, iris forceps.....53
- blades, scalpel.....11
- BLAIR, lip and cleft palate
instrument.....106
- BÖHLER, rongeur.....98
- BÖHLER, bone cutting forceps.....99
- BOIES, elevator.....102
- bone cutting forceps, BÖHLER.....99
- bone cutting forceps,
COTTLE-KAZANJIAN.....99
- bone cutting forceps, MC INDOE...99
- BONN, scissors.....20
- BONNEY, tissue forceps.....45
- BREAST, retractor.....79
- breast, spatula.....80
- BROWN, tissue forceps.....41
- BRUENINGS, septum forceps.....119
- C**
- caliper, CASTROVIEJO.....4
- CAPLAN, nasal cutting forceps....122
- cartilage crusher, COTTLE.....133
- cartilage crusher, JOST.....133
- CASTROVIEJO, caliper.....4
- CASTROVIEJO, suture forceps....55
- CASTROVIEJO, needle holder.....96
- CHADWICK, scissors.....26
- chalazion forceps, DESMARRES...55
- chisel, COTTLE.....129
- chisel, WEST.....132
- cilia forceps, BARRAQUER.....55
- COLLER-CRILE, forceps.....61
- COLLIER, pelvimeter.....4
- COLLIN-DUVAL, tissue forceps....42
- columella forceps, COTTLE.....57
- CONVERSE, retractor.....87
- CONVERSE, retractor.....89
- CONVERSE, knife.....125
- CONVERSE/WILMER/WALTER,
scissors.....22
- CORONAL, retractor.....79
- COTTLE, scissors.....22, 27
- COTTLE, ear forceps.....57
- COTTLE, columella forceps.....57
- COTTLE, retractor.....87, 88, 89
- COTTLE, mallet.....100
- COTTLE, elevator.....103, 104
- COTTLE, nasal specula.....115, 116
- COTTLE, knife.....125
- COTTLE, osteotome.....129
- COTTLE, chisel.....129
- COTTLE, cartilage crusher.....133
- COTTLE JOSEPH, elevator.....103
- COTTLE-KAZANJIAN, bone
cutting forceps.....99
- COTTLE-MASING, scissors.....27
- COTTLE-NEIVERT, retractor.....88
- CRILE, forceps.....62
- CRILE, retractor.....65
- CRILE, hook.....85
- CRILE-RANKIN, forceps.....62
- CRILE-WOOD, needle holder.....92
- CRONIN, lip and cleft palate
instrument.....105
- CUSHING, hook.....85
- CUSHING, tissue forceps.....41
- CUSHING-TAYLOR,
dressing forceps.....44
- D**
- D'ASSUMPACO, facelift marker.....3
- DAVIS-BOYLE, mouth gag.....142
- DAVIS-MEYER, mouth gag.....144
- DEAVER, retractor.....67
- DeBAKEY, atrauma forceps...49, 50, 51
- DeBAKEY, needle holder.....92
- DERF, needle holder.....91
- dermatome, HUMBY.....6
- dermatome, SCHINK.....5
- dermatome, SILVER.....6
- dermatome, WATSON.....6
- DESMARRES, chalazion forceps...55
- DESMARRES, retractor.....73
- DINGMAN, nasal rasp.....138
- DINGMANN, mouth gag.....143
- DINGMANN, elevator.....150
- dissector, AGRIS-DINGMAN.....82
- dissector, GORNEY.....102
- dissector, LANGENBECK.....77
- dissector, MacCOLLUM-DINGMAN...83
- dissector, MINI-LANGENBECK.....77
- dissector, SILVERSTEIN.....83
- DOLPHIN, endoscopic grasper...157
- dressing, forceps.....36, 37, 43
- dressing forceps, ADSON.....38
- dressing forceps,
ADSON-DeBAKEY.....38
- dressing forceps,
CUSHING-TAYLOR.....44
- dressing forceps, GERALD.....43, 44
- dressing forceps, McINDOE.....42
- dressing forceps, OCHSNER.....45
- dressing forceps, POTTS-SMITH...36
- dressing forceps, SEMKEN.....43
- dressing forceps, SINGLEY.....45
- dressing forceps, STILLE.....36
- dressing forceps, TAYLOR.....44
- dressing forceps, USA.....36
- DURANTE, tissue forceps.....45
- DUVAL, tissue forceps.....42
- E**
- ear forceps, COTTLE.....57
- ear forceps,
JANSEN-GRUENWALD.....57
- ear forceps, LUCAE.....57
- ear forceps, TROELTSCH.....57
- ear forceps, WILDE (TROELTSCH)...57
- ear polypus forceps, HARTMANN...117
- elevator, BALLENGER.....104

- elevator, BOIES102
elevator, COTTLE103, 104
elevator, COTTLE JOSEPH103
elevator, DINGMANN150
elevator, FREER102
elevator, FREER128
elevator, HAJEK-BALLENGER104
elevator, HOWARTH103
elevator, JOSEPH102
elevator, KILLIAN103, 104
elevator, LANGENBECK101
elevator, MASING102
elevator, McKENTY102, 103
elevator, OBWEGESER149
elevator, PENNINGTON103
elevator, PIERCE103
elevator, WILLIGER101
endoscope, plastic surgery153
endoscope shaft,
plastic surgery153, 154, 155
endoscopic, heavy grasper157
endoscopic, hook scissors156
endoscopic grasper, DOLPHIN157
endoscopic grasper,
MARYLAND157
endoscopic scissors,
METZENBAUM156
- F**
facelift marker, D'ASSUMPACO3
facelift marker, LOCKWOOD3
facelift marker, PITANGUY3
FARABEUF, retractor65
FERRIERA, retractor78
FERRIS-SMITH, tissue forceps42
finger, goniometer2
FINSSEN, retractor75
fixation forceps, GREEN56
FOERSTER, knife127
FOMON, scissors27
FOMON, retractor88
FOMON, raspatory101
FOMON, nasal rasp136, 137
FOMON, nasal rasp137
forceps, ADSON64
forceps, COLLIER-CRILE61
forceps, CRILE62
forceps, CRILE-RANKIN62
forceps, dressing36, 37, 43
forceps, HALSTED-MOSQUITO60
forceps, HARTMANN59
forceps, KELLY61
- forceps, KELLY-RANKIN61
forceps, LERICHE63
forceps, micro suture tying47
forceps, micro ring48
forceps, MICRO-HARTMANN59
forceps, PROVIDENCE-HOSPITAL61
forceps, ROCHESTER-OCHSNER63
forceps, ROCHESTER-PEAN63
forceps, splinter46
forceps, tissue36, 37
FRAZIER/FERGUSON,
suction tube108
FREEMAN, marker4
FREEMAN, retractor68, 79, 81
FREER, retractor88
FREER, elevator102
FREER, knife124
FREER, elevator128
FREER, gouge132
FRIEDMANN, rongeur98
FRIEDMANN MINI, rongeur98
- G**
GERALD, dressing forceps43, 44
GERALD, tissue forceps44
GERZOG, mallet100
GILLIES, tissue forceps43
GILLIES, retractor89
GILLIES, needle holder94
GLABELLA, nasal rasp134
GOLDMAN-FOX, scissors29
goniometer, finger2
goniometer, MOELTGEN2
GORNEY, scissors30
GORNEY, retractor81
GORNEY, dissector102
GORNEY-FREEMAN, scissors30
gouge, FREER132
gouge, HAJEK132
gouge, KILLIAN130
gouge, KILLIAN-KLAUS132
gouge, WEST132
GRADLE, scissors23
GRAEFE, scissors22
GRAEFE, tissue forceps41
GRAEFE, iris forceps52
GRAEFE, retractor69
GRAIG, septum forceps119
GREEN, fixation forceps56
GREENBERG-PAR, scissors32
GUILLEN, suction tube109
GUTHRIE, retractor69
- H**
HAJEK, gouge132
HAJEK-BALLENGER, elevator104
HALSEY, needle holder91
HALSTED-MOSQUITO, forceps60
handles, scalpel7, 8, 9, 10, 12
HARTMANN, forceps59
HARTMANN, nasal specula111
HARTMANN, ear polypus forceps117
HARTMANN-HALLE,
nasal specula110
heavy grasper, endoscopic157
HEYMAN, scissors27
HEYMANN-KNIGHT,
nasal forceps118
HOLZHEIMER, retractor75
hook, ADSON85
hook, CRILE85
hook, CUSHING85
hook, JACKSON90
hook, nerve77
hook, NEWS90
hook scissors, endoscopic156
HOWARTH, elevator103
HUMBY, dermatome6
HUMBY, retractor71
- I**
IRIS, scissors20
iris forceps, BISHOP-HARMAN53
iris forceps, GRAEFE52
- J**
JACKSON, hook90
JAEGER, lid plate58
JANSEN, retractor75
JANSEN-GRUENWALD,
ear forceps57
JENNINGS, tongue depressor141
J-Hook electrode, monopolar158
JOSEPH, scissors18
JOSEPH, retractor70
JOSEPH, raspatory101
JOSEPH, elevator102
JOSEPH, knife124, 125
JOSEPH, nasal rasp134
JOSEPH, nasal saw138, 139
JOSEPH (LEWIS), nasal rasp135
JOST, cartilage crusher133

- K**
- KASDAN, retractor.....73
- KAYE, scissors 31, 32
- KELLY, scissors19
- KELLY, forceps61
- KELLY-RANKIN, forceps61
- KILLIAN, elevator103, 104
- KILLIAN, nasal specula113, 114
- KILLIAN, gouge130
- KILLIAN-KLAUS, gouge132
- KILNER, scissors.....19
- KILNER, retractor88
- KILNER-DOUGHTY, mouth gag...143
- KLAPP, retractor72
- KLEINERT-KUTZ, retractor70
- KNAPP, scissors21
- KNAPP, retractor86
- knife, BALLENGER126
- knife, CONVERSE.....125
- knife, COTTLE.....125
- knife, FOERSTER127
- knife, FREER124
- knife, JOSEPH.....124, 125
- knife, REDA125
- KNIGHT, nasal forceps118
- L**
- LA GRANGE, scissors26
- LAHEY, retractor70
- LANGE, retractor89
- LANGENBECK, dissector.....77
- LANGENBECK, elevator101
- LANGENBECK-COTTLE, dissector...77
- LERCHE, tissue forceps41
- LERICHE, forceps63
- LEXER, scissors15
- LEXER-BABY, scissors15
- lid plate, JAEGER58
- lip and cleft palate instrument,105
- lip and cleft palate instrument,
BLAIR106
- lip and cleft palate instrument,
CRONIN105
- LITTAUER, scissors28
- LITTLER, scissors22
- LOCKWOOD, facelift marker.....3
- LUBET-BARBON, nasal forceps...117
- LUC, septum forceps119
- LUCAE, ear forceps57
- M**
- MacCOLLUM-DINGMAN, dissector...83
- MALINIAC, retractor87
- mallet, COTTLE.....100
- mallet, GERZOG100
- mallet, MEAD.....100
- mallet, nylon cap.....100
- mallet, PARTSCH100
- mallet, QUISLING.....100
- MALTZ, nasal rasp134
- MALTZ (COTTLE), nasal rasp...135
- marker, FREEMAN4
- marker, McKISSOCK.....4
- MARYLAND, endoscopic grasper...157
- MASING, elevator102
- MASING-NEIVERT, retractor87
- MAYO, scissors13
- MAYO-HABERISSER, wire
twisting forceps97
- MAYO-HEGAR, needle holder92
- MAYO-STILLE, scissors14
- MC INDOE, scissors29
- MC INDOE, bone cutting forceps...99
- McINDOE, tissue forceps42
- McINDOE, dressing forceps42
- McIVOR, mouth gag144
- McKENTY, elevator102, 103
- McKISSOCK, marker.....4
- MEAD, mallet.....100
- metal, ruler.....2
- METZENBAUM, scissors16, 17
- METZENBAUM,
endoscopic scissors156
- METZENBAUM-FINO, scissors.....17
- MEYERDING, retractor74
- micro, scissors33, 34, 35
- micro suture tying, forceps47
- micro ring, forceps48
- MICRO-HARTMANN, forceps59
- MICROVASCULAR, needle holder...93
- MIDDLETON-JANSEN,
septum forceps123
- MILLER, retractor86
- MINI-LAMBOTTE, osteotome.....132
- MINI-LANGENBECK, dissector.....77
- MOD. BONN, suture forceps54
- MOD. TUEBINGEN, suture forceps...54
- Mod. WIEN, nasal specula112
- MOELTGEN, goniometer.....2
- monopolar, J-Hook electrode.....158
- monopolar, Spatula electrode.....158
- mouth gag, DAVIS-BOYLE.....142
- mouth gag, DAVIS-MEYER144
- mouth gag, DINGMANN143
- mouth gag, KILNER-DOUGHTY...143
- mouth gag, McIVOR144
- muscle forceps, BERKE55
- MYLES, nasal cutting forceps121
- N**
- nasal cutting forceps, CAPLAN122
- nasal cutting forceps, MYLES121
- nasal cutting forceps,
SCHMEDEN121
- nasal cutting forceps,
TAKAHASHI121
- nasal cutting forceps,
WEIL-BLAKESLEY120
- nasal forceps,
HEYMANN-KNIGHT118
- nasal forceps, KNIGHT118
- nasal forceps, LUBET-BARBON...117
- nasal forceps, WESTMACOTT117
- nasal rasp, AUFRICHT135
- nasal rasp, DINGMAN138
- nasal rasp, FOMON.....136, 137
- nasal rasp, FOMON.....137
- nasal rasp, GLABELLA.....134
- nasal rasp, JOSEPH.....134
- nasal rasp, JOSEPH (LEWIS).....135
- nasal rasp, MALTZ134
- nasal rasp, MALTZ (COTTLE).....135
- nasal rasp, PARKES.....134
- nasal rasp, PEET134
- nasal rasp, WIENER.....134
- nasal rasp, wire brush138
- nasal saw, JOSEPH138, 139
- nasal specula, COTTLE.....115, 116
- nasal specula, HARTMANN.....111
- nasal specula,
HARTMANN-HALLE110
- nasal specula, KILLIAN.....113, 114
- nasal specula, Mod. WIEN112
- nasal specula, REDA112
- nasal specula, TIECK-HALLE.....112
- needle holder,
BABY OLSEN-HEGAR93
- needle holder, BARRAQUER95
- needle holder, BAUMGARTNER...92
- needle holder, CASTROVIEJO.....96
- needle holder, CRILE-WOOD.....92
- needle holder, DeBAKEY92
- needle holder, DERF91
- needle holder, GILLIES94

- needle holder, HALSEY91
 needle holder, MAYO-HEGAR92
 needle holder, MICROVASCULAR93
 needle holder, OLSEN-HEGAR93
 needle holder, RYDER93
 needle holder, WEBSTER91
 NEIVERT-ANDERSON,
 osteotome130
 nerve, hook77
 NEWS, hook90
 nylon cap, mallet100
- O**
- O'BRIEN, scissors28
 OBWEGESER, osteotome131
 OBWEGESER, retractor...146, 147, 148
 OBWEGESER, elevator149
 OCHSNER, dressing forceps45
 O'CONNOR, retractor86
 OEHLER, tissue forceps37
 OLSEN-HEGAR, needle holder93
 osteotome, COTTLE129
 osteotome, MINI-LAMBOTTE132
 osteotome,
 NEIVERT-ANDERSON130
 osteotome, OBWEGESER131
 osteotome, RUBIN129
 osteotome, SILVER130
 osteotome, TESSIER151
- P**
- PARKES, nasal rasp134
 PARTSCH, mallet100
 PECK-JOSEPH, scissors31
 PEET, nasal rasp134
 pelvimeter, COLLIER4
 PENNINGTON, elevator103
 PIERCE, elevator103
 PITANGUY, facelift marker3
 plastic surgery, endoscope153
 endoscope shaft153, 154, 155
 POTTS-SMITH, dressing forceps...36
 POTTS-SMITH, tissue forceps36
 probe, SINUS103
 PROVIDENCE-HOSPITAL,
 forceps61
- Q**
- QUISLING, mallet100
- R**
- RAGNELL, retractor65
 RAMUS, retractor148
 raspatory, FOMON101
 raspatory, JOSEPH101
 raspatory, TESSIER150
 REDA, retractor72
 REDA, nasal specula112
 REDA, knife125
 retractor, ALM75
 retractor, ANDERSON79
 retractor, AUFRIECHT87
 retractor, BARSKY71
 retractor, BIGGS84
 retractor, BREAST79
 retractor, CONVERSE87
 retractor, CONVERSE89
 retractor, CORONAL79
 retractor, COTTLE87, 88, 89
 retractor, COTTLE-NEIVERT88
 retractor, CRILE65
 retractor, DEAVER67
 retractor, DESMARRÉS73
 retractor, FARABEUF65
 retractor, FERRIERA78
 retractor, FINSEN75
 retractor, FOMON88
 retractor, FREEMAN68, 79, 81
 retractor, FREER88
 retractor, GILLIES89
 retractor, GORNEY81
 retractor, GRAEFE69
 retractor, GUTHRIE69
 retractor, HOLZHEIMER75
 retractor, HUMBY71
 retractor, JANSEN75
 retractor, JOSEPH70
 retractor, KASDAN73
 retractor, KILNER88
 retractor, KLAPP72
 retractor, KLEINERT-KUTZ70
 retractor, KNAPP86
 retractor, LAHEY70
 retractor, LANGE89
 retractor, MALINIAC87
 retractor, MASING-NEIVERT87
 retractor, MEYERDING74
 retractor, MILLER86
 retractor, OBWEGESER...146, 147, 148
 retractor, O'CONNOR86
 retractor, RAGNELL65
 retractor, RAMUS148
- retractor, REDA72
 retractor, RIBBON66
 retractor, ROLLET86
 retractor, ROUX65
 retractor, SPINA-NASALIS148
 retractor, STRANDELL-STILLE74
 retractor, TEBBETS78, 83
 retractor, TYRELL69
 retractor, VOLKMANN73
 retractor, WEITLANER76
 retractor, WIENER86
 retractor, YANKOSKIE79
 REYNOLDS, scissors19
 RIBBON, retractor66
 ROCHESTER-OCHSNER, forceps...63
 ROCHESTER-PEAN, forceps63
 ROLLET, retractor86
 rongeur, BEYER98
 rongeur, BÖHLER98
 rongeur, FRIEDMANN98
 rongeur, FRIEDMANN MINI98
 ROUX, retractor65
 RUBIN, septum forceps122
 RUBIN, osteotome129
 ruler, metal2
 RUSSEL-DAVIS, tongue
 depressor145
 RUSSIAN PATTERN, tissue
 forceps42
 RYDER, needle holder93
- S**
- SANVENERO, scissors18
 scalpel, handles7, 8, 9, 10, 12
 scalpel, blades11
 scalpel blade remover,11
 SCHINK, dermatome5
 SCHMEDEN, nasal cutting
 forceps121
 scissors, BEUSE31
 scissors, BONN20
 scissors, CHADWICK26
 scissors,
 CONVERSE/WILMER/WALTER22
 scissors, COTTLE22, 27
 scissors, COTTLE-MASING27
 scissors, FOMON27
 scissors, GOLDMAN-FOX29
 scissors, GORNEY30
 scissors, GORNEY-FREEMAN30
 scissors, GRADLE23
 scissors, GRAEFE22

scissors, GREENBERG-PAR32	STEVENS, scissors.....24	tongue depressor,
scissors, HEYMAN27	STILLE, dressing forceps36	RUSSEL-DAVIS145
scissors, IRIS.....20	STILLE, tissue forceps37	tongue depressor, WIEDER141
scissors, JOSEPH18	STILLE-BARRAYA, tissue forceps.....45	TROELTSCH, ear forceps57
scissors, KAYE31, 32	STRABISMUS, scissors24	TYRELL, retractor.....69
scissors, KELLY.....19	STRANDELL-STILLE, retractor.....74	
scissors, KILNER.....19	suction tube, BARON107	U
scissors, KNAPP21	suction tube, ADSON.....107	USA, dressing forceps36
scissors, LA GRANGE.....26	suction tube,	USA, tissue forceps37
scissors, LEXER.....15	FRAZIER/FERGUSSON108	
scissors, LEXER-BABY15	suction tube, GUILLEN.....109	V
scissors, LITTAUER28	suture forceps, CASTROVIEJO55	VOLKMANN, retractor73
scissors, LITTLER22	suture forceps, MOD. BONN54	
scissors, MAYO13	suture forceps, MOD. TUEBINGEN...54	W
scissors, MAYO-STILLE14		WAGNER, scissors.....25
scissors, MC INDOE.....29	T	WALSHAM, septum
scissors, METZENBAUM16, 17	TAKAHASHI, nasal cutting forceps..121	straightening forceps140
scissors, METZENBAUM-FINO.....17	TAYLOR, dressing forceps44	WALTER/CONVERSE/WILMER,
scissors, micro.....33, 34, 35	TAYLOR, tissue forceps.....44	scissors.....22
scissors, O'BRIEN28	TEBBETS, retractor.....78, 83	WATSON, dermatome6
scissors, PECK-JOSEPH31	TESSIER, raspatory150	WAUGH, tissue forceps.....41
scissors, REYNOLDS19	TESSIER, osteotome151	WEBSTER, needle holder91
scissors, SANVENERO18	TIECK-HALLE, nasal specula.....112	WEIL-BLAKESLEY, nasal
scissors, SPENCER28	tissue, forceps36, 37	cutting forceps120
scissors, STEVENS.....24	tissue forceps, ADSON.....38, 39	WEITLANER, retractor76
scissors, STRABISMUS24	tissue forceps, ADSON-BROWN.....40	WEST, gouge.....132
scissors, WAGNER.....25	tissue forceps,	WEST, chisel132
scissors, WILMER/CONVERSE22	BEASELEY BABCOCK39	WESTMACOTT, nasal forceps117
SEMKEN, dressing forceps43	tissue forceps, BONNEY45	WILDE (TROELTSCH), ear forceps ..57
SEMKEN, tissue forceps43	tissue forceps, BROWN.....41	WIEDER, tongue depressor141
septum forceps, BRUENINGS.....119	tissue forceps, COLLIN-DUVAL.....42	WIENER, retractor86
septum forceps, GRAIG.....119	tissue forceps, CUSHING.....41	WIENER, nasal rasp.....134
septum forceps, LUC.....119	tissue forceps, DURANTE.....45	WILLIGER, elevator.....101
septum forceps,	tissue forceps, DUVAL.....42	WILMER/CONVERSE/WALTER,
MIDDLETON-JANSEN123	tissue forceps, FERRIS-SMITH.....42	scissors.....22
septum forceps, RUBIN122	tissue forceps, GERALD.....44	wire brush, nasal rasp138
septum straightening forceps,	tissue forceps, GILLIES.....43	wire twisting forceps, BERRY97
ASCH.....140	tissue forceps, GRAEFE.....41	wire twisting forceps,
septum straightening forceps,	tissue forceps, LERCHE.....41	MAYO-HABERISSER97
WALSHAM.....140	tissue forceps, McINDOE.....42	
SILVER, dermatome6	tissue forceps, OEHLER.....37	Y
SILVER, osteotome130	tissue forceps, POTTS-SMITH36	YANKOSKIE, retractor.....79
SILVERSTEIN, dissector.....83	tissue forceps,	
SINGLEY, dressing forceps45	RUSSIAN PATTERN42	
SINUS, probe103	tissue forceps, SEMKEN43	
skin plate for dermatomes5	tissue forceps, STILLE37	
spare blades for dermatomes5, 6	tissue forceps, STILLE-BARRAYA.....45	
spatula, breast.....80	tissue forceps, TAYLOR.....44	
Spatula electrode, monopolar.....158	tissue forceps, USA37	
SPENCER, scissors.....28	tissue forceps, WAUGH.....41	
SPINA-NASALIS, retractor.....148	tongue depressor, ANDREW141	
splinter, forceps46	tongue depressor, JENNINGS.....141	

A	BÖHLER pinza gubia.....	98, 99	CRILE-WOOD porta aguja	92
abre-boca DAVIS-BOYLE.....	BOIES elevador.....	102	CRIONIN instrumento	
abre-boca DAVIS-MEYER.....	BONN Mod. pinza para sutura.....	54	para labios y fisura palatina.....	106
abre-boca DINGMANN.....	BONN tijera fina.....	20	cuchillo nasal CONVERSE.....	125
abre-boca JENNINGS.....	BONNEY pinza de diseccion.....	45	cuchillo nasal COTTLE.....	125
abre-boca KILNER-DOUGHTY.....	BREAST separador.....	79	cuchillo nasal FREER.....	124
abre-boca McIVOR.....	BROWN pinza de diseccion.....	41	cuchillo nasal JOSEPH.....	124, 125
ADSON gancho para duramadre.....	BRUENINGS pinza para el		cuchillo nasal REDA.....	125
ADSON	tabique nasal.....	119	cuchillo para capsula FOERSTER.....	127
micro pinza de diseccion.....			cuchillo para el tabique nasal	
ADSON pinza de diseccion.....	C		BALLENGER.....	126
ADSON pinza hemostatica.....	CAPLAN tijera para cartilago.....	122	CUSHING gancho para nervios.....	85
ADSON tubo de aspiracion.....	CASTROVIEJO compas.....	4	CUSHING pinza de diseccion.....	41
ADSON-BROWN	CASTROVIEJO micro porta aguja.....	96	CUSHING-TAYLOR pinza de	
pinza de diseccion.....	CASTROVIEJO pinza para sutura.....	55	diseccion.....	44
ADSON-DeBAKEY	cepillo de alambre.....	138		
pinza de diseccion.....	CHADWICK tijera fina.....	26	D	
AGRIS-DINGMAN	cincel COTTLE.....	129	D'ASSUMPACO instrumento	
separador mamario.....	cincel SILVER.....	130	para marcar.....	3
ALM separador.....	COLLER-CRILE pinza hemostatica.....	61	DAVIS-BOYLE abre-boca.....	142
ANDERSON separador.....	COLLIER pelvimetro.....	4	DAVIS-MEYER abre-boca.....	144
ANDREW baja-lengua.....	COLLIN-DUVAL pinza de diseccion.....	42	DEAVER separador.....	67
ASCH pinza para enderezar	compas CASTROVIEJO.....	4	DeBAKEY pinza atraumatica.....	51
el tabique nasal.....	CONVERSE cuchillo nasal.....	125	DeBAKEY porta aguja.....	92
AUFRICT escofina nasal.....	CONVERSE separador.....	89	DERF porta aguja.....	91
AUFRICT separador nasal.....	CONVERSE separador nasal.....	87	dermatomo HUMBY.....	6
	CONVERSE/WILMER/WALTER		dermatomo SCHINK.....	5
B	tijera fina.....	22	dermatomo SILVER.....	6
BABY OLSEN-HEGAR porta aguja.....	CORONAL separador.....	79	dermatomo WATSON.....	6
baja-lengua ANDREW.....	COTTLE cincel.....	129	DESMARRES pinza para chalazion.....	55
baja-lengua McIVOR.....	COTTLE cuchillo nasal.....	125	DESMARRES separador.....	73
baja-lengua RUSSEL-DAVIS.....	COTTLE elevador para tabique.....	104	DINGMAN elevador.....	150
baja-lengua WIEDER.....	COTTLE escofina nasal.....	135	DINGMAN escofina nasal.....	138
BALLENGER cuchillo para el	COTTLE especulo nasal.....	115, 116	DINGMAN legra.....	150
tabique nasal.....	COTTLE JOSEPH elevador.....	103	DINGMANN abre-boca.....	143
BALLENGER elevador para	COTTLE legra.....	104	disector GORNEY.....	102
tabique.....	COTTLE macha cadera.....	133	disector LANGENBECK.....	77
BARON tubo de aspiracion.....	COTTLE martillo.....	100	disector LANGENBECK-COTTLE.....	77
BARRAQUER micro porta aguja.....	COTTLE osteotomo.....	129	disector MINI-LANGENBECK.....	77
BARRAQUER pinza depilatoria.....	COTTLE pinza para columela.....	57	DURANTE pinza de diseccion.....	45
BARSKY separador.....	COTTLE pinza para fijacion.....	57	DUVAL pinza de diseccion.....	42
BAUMGARTNER porta aguja.....	COTTLE separador.....	89		
BEASELEY BABCOCK pinza de	COTTLE separador nasal.....	87, 88		
diseccion.....	COTTLE tijera fina.....	22		
BERKE pinza muscular.....	COTTLE tijera nasal.....	27		
BERRY pinza para torcer hilos.....	COTTLE-KAZANJIAN pinza gubia.....	99		
BEUSE Face Lift tijera.....	COTTLE-MASING tijera nasal.....	27		
BEYER pinza gubia.....	COTTLE-NEIVERT separador nasal.....	88		
BIGGS separador.....	CRILE gancho para nervios.....	85		
BISHOP-HARMAN pinza para iris.....	CRILE pinza hemostatica.....	62		
BLAIR instrumento para labios y	CRILE separador.....	65		
fisura palatina.....	CRILE-RANKIN pinza hemostatica.....	62		

E	FERRIS-SMITH pinza de diseccion42	GREEN pinza para fijacion56
elevador BOIES102	FINSEN separador75	GREENBERG-PAR tijera para blefaroplastia32
elevador COTTLE JOSEPH103	FOERSTER cuchillo para capsula127	gubia FREER132
elevador DINGMAN150	FOMON escofina nasal136, 137	gubia HAJEK132
elevador FREER102, 128	FOMON legra101	gubia KILLIAN130
elevador HOWARTH103	FOMON separador nasal88	gubia KILLIAN-CLAUS132
elevador JOSEPH102, 103	FOMON tijera nasal27	gubia WEST132
elevador KILLIAN103, 104	FRAZIER separador70	GUILLEN tubo de aspiracion109
elevador MASING102	FRAZIER/FERGUSSON tubo de aspiracion108	GUTHRIE separador69
elevador McKENTY102, 103	FREEMAN Face separador81	H
elevador para tabique BALLENGER104	FREEMAN marcador para aréola4	HAJEK gubia132
elevador para tabique COTTLE104	FREEMAN separador68	HAJEK-BALLENGER elevador para tabique104
elevador para tabique HAJEK-BALLENGER104	FREEMAN separador79	HALSEY porta aguja91
elevador PENNINGTON103	FREER cuchillo nasal124	HALSTEAD-MOSQUITO micro pinza hemostatica60
elevador PIERCE103	FREER elevador102, 128	HALSTEAD-MOSQUITO pinza hemostatica60
elevador SINUS103	FREER gubia132	HARTMANN espejito nasal111
escofina nasal AUFRIEHT135	FREER separador nasal88	HARTMANN pinza hemostatica59
escofina nasal COTTLE135	FRIEDMANN MICRO pinza gubia98	HARTMANN pinza para polipos ...117
escofina nasal DINGMAN138	FRIEDMANN MINI pinza gubia98	HARTMANN-HALLE espejito nasal110
escofina nasal FOMON136, 137	FRIEDMANN pinza gubia98	HEYMAN tijera nasal27
escofina nasal GLABELLA134	G	HEYMAN-KNIGHT pinza para polipos118
escofina nasal JOSEPH134, 135	gancho para duramadre ADSON85	hoja de repuesto para dermatomo5, 6
escofina nasal LEWIS135	gancho para nervios77, 85	hojas de bisturie11
escofina nasal MALTZ134, 135	gancho para nervios CRILE85	HOLZHEIMER separador75
escofina nasal PARKES134	gancho para nervios CUSHING85	HOWARTH elevador103
escofina nasal PEET134	gancho para traqueotomia JACKSON90	HUMBY dermatomo6
escofina nasal WIENER134	gancho para traqueotomia NEWS90	HUMBY separador71
espatula80	GERALD pinza de diseccion ...43, 44	I
espatula abdominal e intestinal RIBBON66	GERZOG martillo100	instrumento para labios y fisura palatina BLAIR106
espejito nasal COTTLE115, 116	GILLIES pinza de diseccion43	instrumento para labios y fisura palatina CRIONIN106
espejito nasal HARTMANN111	GILLIES porta aguja94	instrumento para marcar D'ASSUMPACO3
espejito nasal HARTMANN-HALLE110	GILLIES separador89	instrumento para marcar LOCKWOOD3
espejito nasal KILLIAN113, 114	GLABELLA escofina nasal134	instrumentos para endoscopia .152-158
espejito nasal Mod. WIEN112	GOLDMAN-FOX tijera para encias29	instrumentos para labios y fisura palatina105, 106
espejito nasal REDA112	goniometro MOELTGEN2	IRIS tijera fina20
espejito nasal TIECK-HALLE112	goniometro para dedos2	
F	GORNEY disector102	
Face Lift tijera BEUSE31	GORNEY Face Lift tijera30	
Face Lift tijera GORNEY30	GORNEY separador81	
Face Lift tijera GORNEY-FREEMAN30	GORNEY-FREEMAN Face Lift tijera30	
Face Lift tijera KAYE31	GRADLE tijera fina23	
Face Lift tijera PECK-JOSEPH31	GRAEFE pinza de diseccion41	
FARABEUF separador65	GRAEFE pinza para iris52	
FERGUSSON/FRAZIER tubo de aspiracion108	GRAEFE separador69	
FERRIERA separador78	GRAEFE tijera fina22	
	GRAIG pinza para el tabique nasal119	

J	legra OBWEGESER.....149	METZENBAUM-FINO tijera de
JACKSON gancho para	legra WILLIGER.....101	diseccion.....17
traqueotomia.....90	LERCHE pinza de diseccion.....41	MEYERDING separador.....74
JAEGER placa para parado.....58	LERICHE pinza hemostatica.....63	MICRO FRIEDMANN pinza gubia.....98
JANSEN separador.....75	LEWIS escofina nasal.....135	micro pinzas.....47-49
JANSEN-GRUENWALD pinza	LEXER tijera de diseccion.....15	micro porta aguja BARRAQUER.....95
auricular.....57	LEXER-BABY tijera de diseccion.....15	micro porta aguja CASTROVIEJO.....96
JENNINGS abre-boca.....141	LITTAUER tijera para hilos.....28	micro tijeras.....33-35
JOSEPH cuchillo nasal.....124, 125	LITTLER tijera fina.....22	MICROVASCULAR porta aguja.....93
JOSEPH elevador.....102, 103	LOCKWOOD instrumento para	MIDDLETON-JANSEN pinza
JOSEPH escofina nasal.....134, 135	marcar.....3	para el tabique nasal.....123
JOSEPH legra.....101	LUBET-BARBON pinza para	MILLER separador.....86
JOSEPH separador.....70	taponamiento.....117	MINI-LAMBOTTE osteotomo.....132
JOSEPH sierra nasal.....138, 139	LUC pinza para el tabique nasal.....119	MINI-LANGENBECK disector.....77
JOSEPH tijera de diseccion.....18	LUCAE pinza auricular.....57	Mod. BONN pinza para sutura.....54
JOST macha cadera.....133		Mod. RUSO pinza de diseccion.....42
		Mod. TUEBINGEN pinza para
K	M	sutura.....54
KASDAN separador.....73	MacCOLLUM-DINGMAN	Mod. WIEN especulo nasal.....112
KAYE Face Lift tijera.....31	separador mamario.....83	MOELTGEN goniometro.....2
KAYE tijera para blefaroplastia.....32	macha cadera COTTLE.....133	MYLES pinza cortante nasal.....121
KAYE tijera para blefaroplastia.....32	macha cadera JOST.....133	
KELLY pinza hemostatica.....61	MALINIAC separador nasal.....87	N
KELLY tijera de diseccion.....19	MALTZ escofina nasal.....134, 135	NEIVERT-ANDERSON osteotomo...130
KELLY-RANKIN pinza hemostatica.....61	mango de bisturie.....7-10, 12	NEWS gancho para traqueotomia.....90
KILLIAN elevador.....103, 104	marcador para aréola FREEMAN.....4	
KILLIAN especulo nasal.....113, 114	marcador para aréola McKISSOCK.....4	O
KILLIAN gubia.....130	marcador para facelift PITANGUY.....3	O'BRIEN tijera para hilos.....28
KILLIAN-CLAUS gubia.....132	martillo COTTLE.....100	O'CONNOR separador.....86
KILLNER separador nasal.....88	martillo GERZOG.....100	OBWEGESER legra.....149
KILNER RAGNELL tijera de	martillo MEAD.....100	OBWEGESER osteotomo.....131
diseccion.....19	martillo PARTSCH.....100	OBWEGESER separador para cirugía
KILNER-DOUGHTY abre-boca.....143	martillo QUISLING.....100	de boca-mandibula-fiscal.....146-148
KLAPP separador.....72	martillos.....100	OCHSNER pinza de diseccion.....45
KLEINERT-LUTZ separador.....70	MARTINEZ-KILNER separador.....89	OEHLER pinza de diseccion.....37
KNAPP separador.....86	MASING elevador.....102	OLSEN-HEGAR BABY porta aguja.....93
KNAPP tijera fina.....21	MASING-NEIVERT separador	OLSEN-HEGAR porta aguja.....93
KNIGHT pinza para el tabique	nasal.....87	osteotomo COTTLE.....129
nasal.....118	MAYO tijera de diseccion.....13	osteotomo MINI-LAMBOTTE.....132
	MAYO-HABERISSER pinza para	osteotomo NEIVERT-ANDERSON...130
L	torcer hilos.....97	osteotomo OBWEGESER.....131
LA GRANGE tijera fina.....26	MAYO-HEGAR porta aguja.....92	osteotomo RUBIN.....129
LAHEY separador.....70	MAYO-STILLE tijera de diseccion.....14	osteotomo TESSIER.....151
LAMBOTTE-MINI osteotomo.....132	MC INDOE pinza gubia.....99	osteotomo WEST.....132
LANGE separador.....89	MC INDOE tijera para cartilago.....29	
LANGENBECK disector.....77	McINDOE pinza de diseccion.....42	
LANGENBECK legra.....101	McIVOR abre-boca.....144	
LANGENBECK-COTTLE disector.....77	McIVOR baja-lengua.....144	
legra COTTLE.....104	McKENTY elevador.....102, 103	
legra DINGMAN.....150	McKISSOCK marcador para aréola.....4	
legra FOMON.....101	MEAD martillo.....100	
legra JOSEPH.....101	METZENBAUM tijera de	
legra LANGENBECK.....101	diseccion.....16, 17	

P			
PARKES escofina nasal	134	pinza de diseccion	
PARTSCH martillo	100	STILLE-BARRAYA.....	45
PECK-JOSEPH Face Lift tijera.....	31	pinza de diseccion TAYLOR	44
PEET escofina nasal	134	pinza de diseccion	
pelvimetro COLLIER.....	4	TAYLOR-CUSHING	44
PENNINGTON elevador	103	pinza de diseccion USA.....	36, 37
PIERCE elevador.....	103	pinza de diseccion WAUGH	41
pinza atraumatica DeBAKEY	51	pinza depilatoria BARRAQUER.....	55
pinza auricular		pinza gubia BEYER	98
JANSEN-GRUENWALD	57	pinza gubia BÖHLER.....	98, 99
pinza auricular LUCAE	57	pinza gubia COTTLE-KAZANJIAN	99
pinza auricular TROELTSCH	57	pinza gubia FRIEDMANN	98
pinza auricular WILDE		pinza gubia FRIEDMANN MINI	98
(TROELTSCH).....	57	pinza gubia MC INDOE	99
pinza cortante nasal MYLES	121	pinza gubia MICRO FRIEDMANN	98
pinza cortante nasal		pinza hemostatica ADSON	64
SCHMEDEN	121	pinza hemostatica COLLER-CRILE...61	
pinza cortante nasal		pinza hemostatica CRILE	62
TAKAHASHI.....	121	pinza hemostatica CRILE-RANKIN ...62	
pinza cortante nasal		pinza hemostatica	
WEIL-BLAKESLEY	120	HALSTEAD-MOSQUITO	60
pinza de diseccion ADSON.....	38, 39	pinza hemostatica	
pinza de diseccion		HALSTEAD-MOSQUITO micro	60
ADSON micro	38, 39	pinza hemostatica HARTMANN	59
pinza de diseccion		pinza hemostatica KELLY	61
ADSON-BROWN	40	pinza hemostatica KELLY-RANKIN ...61	
pinza de diseccion		pinza hemostatica LERICHE	63
ADSON-DeBAKEY	38	pinza hemostatica	
pinza de diseccion		PROVIDENCE-HOSPITAL	61
BEASELEY BABCOCK	39	pinza hemostatica	
pinza de diseccion BONNEY	45	ROCHESTER-OCHSNER.....	63
pinza de diseccion BROWN	41	pinza hemostatica	
pinza de diseccion COLLIN-DUVAL ..42			
pinza de diseccion CUSHING.....	41	ROCHESTER-PEAN	63
pinza de diseccion		pinza muscular BERKE	55
CUSHING-TAYLOR	44	pinza para chalazion	
pinza de diseccion DURANTE.....	45	DESMARRES	55
pinza de diseccion DUVAL	42	pinza para columela COTTLE	57
pinza de diseccion FERRIS-SMITH...42			
pinza de diseccion GERALD	43, 44	pinza para el tabique nasal	
pinza de diseccion GILLIES.....	43	BRUENINGS.....	119
pinza de diseccion GRAEFE	41	pinza para el tabique nasal	
pinza de diseccion LERCHE.....	41	GRAIG	119
pinza de diseccion McINDOE.....	42	pinza para el tabique nasal	
pinza de diseccion Mod. RUSO.....	42	KNIGHT	118
pinza de diseccion OCHSNER.....	45	pinza para el tabique nasal LUC...119	
pinza de diseccion OEHLER	37	pinza para el tabique nasal	
pinza de diseccion POTTS-SMITH.....36			
pinza de diseccion SEMKEN.....	43	MIDDLETON-JANSEN	123
pinza de diseccion SINGLEY.....	45	pinza para el tabique nasal RUBIN...122	
pinza de diseccion STILLE	36, 37	pinza para enderezar el tabique	
		nasal ASCH	140
		pinza para enderezar el tabique	
		nasal WALSHAM	140
		pinza para fijacion COTTLE.....	57
		pinza para fijacion GREEN	56
		pinza para iris BISHOP-HARMAN.....	53
		pinza para iris GRAEFE.....	52
		pinza para polipos HARTMANN ...117	
		pinza para polipos	
		HEYMANN-KNIGHT	118
		pinza para sutura CASTROVIEJO.....	55
		pinza para sutura Mod. BONN.....	54
		pinza para sutura	
		Mod. TUEBINGEN	54
		pinza para taponamiento	
		LUBET-BARBON	117
		pinza para taponamiento	
		WESTMACOTT	117
		pinza para torcer hilos BERRY	97
		pinza para torcer hilos	
		MAYO-HABERISSER	97
		pinzas atraumaticas con TC	50
		pinzas de diseccion sin y con	
		dientes.....	36-45
		pinzas para espinas.....	46
		PITANGUY marcador para facelift...3	
		placa para extender la piel	5
		placa para parado JAEGER	58
		porta aguja BABY OLSEN-HEGAR...93	
		porta aguja BAUMGARTNER.....	92
		porta aguja CRILE-WOOD	92
		porta aguja DeBAKEY	92
		porta aguja DERF	91
		porta aguja GILLIES	94
		porta aguja HALSEY	91
		porta aguja MAYO-HEGAR	92
		porta aguja MICROVASCULAR.....	93
		porta aguja OLSEN-HEGAR.....	93
		porta aguja RYDER	93
		porta aguja WEBSTER	91
		POTTS-SMITH pinza de diseccion....36	
		PROVIDENCE-HOSPITAL	
		pinza hemostatica.....	61
		Q	
		QUISLING martillo.....	100

R	separador GRAEFE.....69	sierra nasal JOSEPH.....138, 139
RAGNELL separador.....65	separador GUTHRIE69	SILVER cincel.....130
RAMUS separador para cirugía	separador HOLZHEIMER.....75	SILVER dermatomo.....6
de boca-mandibula-fiscal.....148	separador HUMBY.....71	SILVERSTEIN separador mamario...83
REDA cuchillo nasal.....125	separador JANSEN.....75	SINGLEY pinza de diseccion.....45
REDA especulo nasal.....112	separador JOSEPH.....70	SINUS elevador.....103
REDA separador.....72	separador KASDAN.....73	SPENCER tijera para hilos.....28
regla.....2	separador KLAPP.....72	SPINA-NASALIS separador para
REYNOLDS JAMESON tijera de	separador KLEINERT-LUTZ.....70	cirugía de boca-mandibula-fiscal.....148
diseccion.....19	separador KNAPP.....86	STEVENS tijera fina.....24
RIBBON espatula abdominal e	separador LAHEY.....70	STILLE pinza de diseccion.....36, 37
intestinal.....66	separador LANGE.....89	STILLE-BARRAYA pinza de
ROCHESTER-OCHSNER pinza	separador mamario	diseccion.....45
hemostatica.....63	AGRIS-DINGMAN.....82	STRABISMUS tijera fina.....24
ROCHESTER-PEAN pinza	separador mamario	STRANDELL-STILLE separador...74
hemostatica.....63	MacCOLLUM-DINGMAN.....83	
ROLLET separador.....86	separador mamario SILVERSTEIN...83	T
ROUX mini separador.....65	separador mamario TEBBETTS...83	TAKAHASHI pinza cortante nasal...121
RUBIN osteotomo.....129	separador MARTINEZ-KILNER.....89	TAYLOR pinza de diseccion.....44
RUBIN pinza para el tabique	separador MEYERDING.....74	TAYLOR-CUSHING pinza de
nasal.....122	separador MILLER.....86	diseccion.....44
RUSO Mod. pinza de diseccion...42	separador nasal AUFRICHT.....87	TEBBETTS separador.....78
RUSSEL-DAVIS baja-lengua.....145	separador nasal CONVERSE.....87	TEBBETTS separador mamario...83
RYDER porta aguja.....93	separador nasal COTTLE.....87, 88	TESSIER osteotomo.....151
	separador nasal	TESSIER separador de
S	COTTLE-NEIVERT.....88	mobilizacion.....150
SANVENERO tijera de diseccion...18	separador nasal FOMON.....88	TIECK-HALLE especulo nasal.....112
SCHINK dermatomo.....5	separador nasal FREER.....88	tijera de diseccion JOSEPH.....18
SCHMEDEN pinza cortante nasal...121	separador nasal KILLNER.....88	tijera de diseccion KELLY.....19
SEMKEN pinza de diseccion.....43	separador nasal MALINIAC.....87	tijera de diseccion
separador ALM.....75	separador nasal	KILNER RAGNELL.....19
separador ANDERSON.....79	MASING-NEIVERT.....87	LEXER.....15
separador BARSKY.....71	separador O'CONNOR.....86	tijera de diseccion LEXER-BABY.....15
separador BIGGS.....84	separador para cirugía de	tijera de diseccion MAYO.....13
separador BREAST.....79	boca-mandibula-fiscal	tijera de diseccion MAYO-STILLE.....14
separador CONVERSE.....89	OBWEGESER.....146-148	tijera de diseccion
separador CORONAL.....79	separador para cirugía de	METZENBAUM.....16, 17
separador COTTLE.....89	boca-mandibula-fiscal RAMUS.....148	tijera de diseccion
separador CRILE.....65	separador para cirugía de	METZENBAUM-FINO.....17
separador de mobilizacion	boca-mandibula-fiscal	REYNOLDS JAMESON.....19
TESSIER.....150	SPINA-NASALIS.....148	tijera de diseccion SANVENERO.....18
separador DEEVER.....67	separador RAGNELL.....65	tijera fina BONN.....20
separador DESMARRS.....73	separador REDA.....72	tijera fina CHADWICK.....26
separador FARABEUF.....65	separador ROLLET.....86	tijera fina
separador FERRIERA.....78	separador ROUX mini.....65	CONVERSE/WILMER/WALTER.....22
separador FINSSEN.....75	separador STRANDELL-STILLE...74	tijera fina COTTLE.....22
separador FRAZIER.....70	separador TEBBETTS.....78	tijera fina GRADLE.....23
separador FREEMAN.....68	separador TYRELL.....69	tijera fina GRAEFE.....22
separador FREEMAN.....79	separador VOLKMANN.....73	tijera fina IRIS.....20
separador FREEMAN Face.....81	separador WEITLANER.....76	tijera fina KNAPP.....21
separador GILLIES.....89	separador WIENER.....86	tijera fina LA GRANGE.....26
separador GORNEY.....81	separador YANKOSKIE.....79	

tijera fina LITTLER.....	22
tijera fina para oftalmología.....	23
tijera fina STEVENS	24
tijera fina STRABISMUS.....	24
tijera fina WAGNER	25
tijera fina WILMER/CONVERSE.....	22
tijera nasal COTTLE	27
tijera nasal COTTLE-MASING.....	27
tijera nasal FOMON	27
tijera nasal HEYMAN	27
tijera para blefaroplastia GREENBERG-PAR	32
tijera para blefaroplastia KAYE	32
tijera para cartilago CAPLAN.....	122
tijera para cartilago MC INDOE	29
tijera para encias GOLDMAN-FOX.....	29
tijera para hilos LITTAUER	28
tijera para hilos O'BRIEN	28
tijera para hilos SPENCER.....	28
TROELTSCH pinza auricular.....	57
tubo de aspiracion ADSON.....	107
tubo de aspiracion BARON.....	107
tubo de aspiracion FRAZIER/FERGUSSON.....	108
tubo de aspiracion GUILLEN	109
TUEBINGEN Mod. pinza para sutura.....	54
TYRELL separador	69

U

USA pinza de diseccion.....	36, 37
-----------------------------	--------

V

VOLKMANN separador	73
--------------------------	----

W

WAGNER tijera fina	25
WALSHAM pinza para enderezar el tabique nasal	140
WALTER/CONVERSE/WILMER tijera fina	22
WATSON dermatomo	6
WAUGH pinza de diseccion	41
WEBSTER porta aguja	91
WEIL-BLAKESLEY pinza cortante nasal	120
WEITLANER separador.....	76
WEST gubia.....	132
WEST osteotomo.....	132
WESTMACOTT pinza para taponamiento	117
WIEDER baja-lengua.....	141
WIEN Mod. espejulo nasal	112
WIENER escofina nasal	134
WIENER separador	86
WILDE (TROELTSCH) pinza auricular.....	57
WILLIGER legra.....	101
WILMER/CONVERSE/WALTER tijera fina	22

Y

YANKOSKIE separador	79
---------------------------	----

A	BONNEY pinze chirurgiche45	COTTLE scalpello per plastica nasale129
Abbassalingua Andrew141	Breast divaricatore79	Cottle specoli nasali115
abbassalingua Davis-Boyle142	BROWN Pinze chirurgiche41	Cottle specoli nasali116
abbassalingua Dingmann143	BRUENINGS pinza per il setto nasale119	Cottle Tritacartilagine133
abbassalingua Kilner-Doughty143	C	Cottle-Joseph elevatore per setto103
abbassalingua Russel-Davis145	Camicia per chirurgia plastica153	COTTLE-MASING forbici nasali27
abbassalingua Wieder141	Camicia per chirurgia plastica154	Cottle-Neivert retrattore nasale88
Adson cannula di aspirazione107	Camicia per chirurgia plastica155	CRILE divaricatore doppio65
ADSON pinza emostatica64	Cannula di aspirazione107	CRILE pinze emostatiche62
Adson uncini per dura-madre85	cannula di aspirazione Baron107	CRILE RANKIN pinze emostatiche62
AGRIS-DINGMAN separatori mammari82	Cannula di aspirazione Guilen109	Crile uncini per nervi85
ALM divaricatori75	Cannule di aspirazione	CRILE WOOD portaghi92
Anderson uncini per pelle79	Frazier/Fergusson108	CUSHING pinza anatomica41
ANDREW abbassalingua141	CAPLAN cesoia per setto nasale122	CUSHING pinza chirurgica 1x241
Apribocca completo Davis-Boyle142	Castroviejo compasso4	Cushing uncini per nervi85
apribocca Dingmann143	Castroviejo micro portaghi96	Cushing-Taylor pinza a baionetta44
apribocca Jennings141	Castroviejo pinze per sutura55	D
apribocca KILNER DOUGHTY143	Cesoia per setto nasale Caplan122	D'ASSUMPACO strumento per marcare3
ASCH pinza per raddrizzare il setto nasale140	Chadwick forbici gingivali26	DAVIS BOYLE abbassalingua142
AUFRIEHT raspa nasale135	Collier-Crile pinze emostatiche61	DAVIS BOYLE apribocca completo142
Aufricht retrattori nasali87	Collier compasso4	Davis-Boyle Telaio solo142
B	COLLIN DUVAL pinza fenestrata42	Davis-Meyer Telaio solo144
Baby OLSEN HEGAR portaghi93	coltello falcato REDA125	DE BAKEY portaghi92
BABY-WEBSTER portaghi91	Coltello per capsula Foerster127	DEAVER divaricatori addominali67
BALLENGER coltello per setto126	Coltello per il setto nasale Freer124	DEBAKEY micro pinza atraumatica49
Ballenger elevatore per setto104	Coltello per mucosa Freer124	DeBakey pinze atraumatiche51
BARON Cannula di aspirazione107	coltello per setto Ballenger126	DeBakey pinze atraumatiche TC50
BARRAQUER micro portaghi95	Compasso Castroviejo4	DERF portaghi91
Barraquer pinza depilatoria55	Compasso Collier4	Dermatomo Humby6
BARSKY uncinetto per pelle71	CONVERSE bisturi per rinoplastica125	Dermatomo Schink5
BAUMGARTNER portaghi92	Converse divaricatore89	Dermatomo Silver6
Berke pinze muscolari55	Converse retrattori nasali87	Dermatomo Watson6
Berry Pinza torcifili97	CONVERSE/WILMER/WALTER forbici delicate22	DESMARRES divaricatori73
BEUSE face lift forbici31	CORONAL divaricatore79	Desmarres pinze per calazio55
BEYER pinza sgorbia98	COTTLE bisturi per setto nasale125	Dingman divaricatore150
Biggs divaricatore con luce fredda84	Cottle divaricatori89	DINGMAN raspa nasale138
Bishop-Harmann pinze per iride53	Cottle elevatore per setto103	DINGMANN abbassalingua143
Bisturi per cartilagine Joseph124	Cottle elevatore per setto104	DINGMANN apribocca143
bisturi per rinoplastica Converse125	Cottle forbici delicate22	DINGMANN periostotomo doppio150
bisturi per rinoplastica Cottle125	COTTLE forbici nasali27	Dischi di ricambio per martello100
Bisturi per rinoplastica Joseph124	COTTLE KAZANJIAN cesoia per ossa99	Dissettor Gorney102
BLAIR elevatore per fessure del palato106	COTTLE martello metallico100	dissettori Williger101
BOEHLER cesoie per ossa99	COTTLE osteotomo129	divaricat. dopp. coppia Farabeuf65
BOEHLER pinza sgorbia98	Cottle pinza per columella57	Divaricatore150
BOIES sgorbia periostotomo102	Cottle retrattore nasale87	Divaricatore Breast79
BONN forcice delicata20	Cottle retrattore nasale88	Divaricatore con luce fredda Biggs84
BONNEY pinza anatomica45		Divaricatore Converse89
BONNEY pinze chirurgiche45		Divaricatore Coronal79

Divaricatore Dingman	150	E	Forbici delicate Littler.....	22
Divaricatore doppio Crile	65	Elettrodi monopolari.....	Forbici delicate Wagner	25
Divaricatore doppio Ragnel	65	Elevatore Langenbeck.....	Forbici endoscopici.....	156
Divaricatore doppio Roux	65	elevatore per periostio Masing	Forbici gengivali Chadwick	26
Divaricatore Freemann	81	Elevatore per setto	Forbici gengivali Goldmann-Fox	29
Divaricatore Gorney.....	81	Elevatore per setto Cottle	Forbici gengivali La Grange.....	26
Divaricatore Kasdan	73	Elevatore per setto Cottle	Forbici gengivali Mc Indoe.....	29
Divaricatore Knapp	86	Elevatore per setto Cottle-Joseph	Forbici nasali Cottle	27
Divaricatore Lange	89	Elevatore per setto Freer.....	Forbici nasali Cottle-Masing	27
Divaricatore Martinez-Kilner	89	Elevatore per setto	Forbici nasali Fomon	27
Divaricatore Miller.....	86	Hajek-Ballenger.....	Forbici nasali Heymann	27
divaricatore Obwegeser	146	Elevatore per setto Howarth	Forbici per dissezione	15
divaricatore Obwegeser	147	Elevatore per setto Joseph	Forbici per dissezione.....	19
divaricatore Obwegeser	148	Elevatore per setto Killian.....	Forbici per dissezione.....	19
Divaricatore O'Connor	86	Elevatore per setto Killian.....	Forbici per dissezione Joseph	18
Divaricatore Ramus	148	Elevatore per setto McKenty	Forbici per dissezione Kilner	19
Divaricatore Rollet	86	Elevatore per setto McKenty	Forbici per dissezione Lexer-Baby	15
Divaricatore Spina-Nasalis	148	Elevatore per setto Pennington	Forbici per dissezione MAYO	13
Divaricatore Tessier	150	Elevatore per setto Pierce	Forbici per dissezione MAYO-Stille.....	14
Divaricatori.....	72	Elevatore per setto Sinus	Forbici per dissezione Metzenbaum...16	
Divaricatori addominali Deaver.....	67	Endo dissettore Langenbeck	Forbici per dissezione Metzenbaum...17	
Divaricatori Alm.....	75	Endo dissettore Langenbeck-Cottle...77	Forbici per dissezione	
Divaricatori Cottle	89	Endo dissettore Mini-Langenbeck	SANVENERO	18
Divaricatori Desmarres	73	F	Forbici per strabismo	24
Divaricatori Ferriera	78	Face lift forbici Beuse	Forbici taglia fili Littauer.....	28
Divaricatori Ferriera	78	Face lift forbici Gorney.....	Forbici taglia fili O'Brien	28
Divaricatori Finsen	75	Face lift forbici Gorney-Freemann	Forbici taglia fili Spencer.....	28
Divaricatori Freeman	68	Face lift forbici Kaye	FRAZIER uncinetto acuto	70
Divaricatori Freeman	79	Face lift forbici Peck-Joseph.....	FRAZIER uncinetto smusso	70
Divaricatori Gillies	89	FARABEUF divaricat.dopp.coppia.....	Frazier/Fergusson cannula di	
Divaricatori Holzheimer	75	Ferriera divaricatori.....	aspirazione	108
Divaricatori Jansen	75	FERRIS SMITH pinze chirurgiche.....	FREEMAN divaricatore	81
Divaricatori Klapp	72	FINSEN divaricatori	Freeman divaricatori.....	68
Divaricatori Lahey.....	70	FOERSTER coltello per capsula	FREEMAN divaricatori.....	79
Divaricatori Meyerding.....	74	FOMON forbici nasali	FREEMAN, strumento per marcare.....	4
divaricatori Strandel-Stille	74	FOMON Periostotomo	FREER coltello per il setto nasale	124
Divaricatori Volkmann	73	FOMON raspa nasale doppia.....	FREER coltello per mucosa	124
Divaricatori Weitlaner.....	76	FOMON raspa nasale doppia.....	FREER elevatore per setto.....	102
Divaricatori Wiener.....	86	Fomon retrattori nasali.....	FREER osteotomo per setto	
Divaricatori Yancoskie	79	forbice delicata Bonn	nasale	128
DURANTE pinze anatomiche	45	Forbici blefaroplastica.....	Freer retrattore nasale.....	88
DUVAL pinza fenestrata	42	forbici bleforoplastica	FREER sgorbia nasale	132
		Greenberg-Par.....	FRIEDMAN MICRO pinza sgorbia.....	98
		Forbici delicate	FRIEDMAN mini pinza sgorbia.....	98
		Forbici delicate		
		CONVERSE/WILMER/WALTER		
		Forbici delicate Cottle		
		Forbici delicate Gradle		
		Forbici delicate Graefe		
		forbici delicate IRIS.....		
		Forbici delicate Knapp.....		

G		I		L	
Ganci per tracheotomia Jackson.....90		Iris forbici delicate20		La Grange forbici gingivali26	
Gancio per tracheotomia News.....90				LAHEY divaricatori.....70	
GERALD pinza chirurgica 1x2.....43		J		Lama di ricambio per dermatomo.....5	
GERALD pinze anatomiche.....43		Jackson ganci per tracheotomia.....90		Lama di ricambio, non sterile.....6	
GERALD pinze chirurgiche44		JANSEN divaricatori.....75		Lame per bisturi.....10	
GERZOG Martello metallico100		Jansen-Gruenwald pinza		Lame per bisturi.....11	
Gillies Divaricatori.....89		auricolare57		Lange divaricatore89	
GILLIES pinze 1x2 denti.....43		JENNINGS apribocca141		LANGENBECK elevatore101	
GILLIES portaghi tagliente.....94		JOSEPH (LEWIS) raspa nasale...135		LANGENBECK Endo disettore.....77	
Glabella raspa nasale134		JOSEPH bisturi per cartilagine...124		LANGENBECK-Cottle Endo	
GOLDMANN-FOX forbici gingivali.....29		JOSEPH bisturi per rinoplastica...124		dissettori77	
Goniometro Moeltgen2		Joseph elevatore per setto102		LERCHE pinza 5x6 denti.....41	
Goniometro per le dita2		JOSEPH forbici per dissezione18		LERICHE pinze emostatiche63	
GORNEY dissetto102		JOSEPH lima per ossa134		LEXER baby forbici per dissezione.....15	
Gorney divaricatore81		JOSEPH Periostotomo101		LEXER forbici per dissezione15	
Gorney face lift forbici.....30		JOSEPH sega nasale138		lima per ossa Joseph.....134	
Gorney-Freemann face lift forbici30		JOSEPH sega nasale angolata...139		LITTAUER forbici taglia fili.....28	
Gradle forbici delicate.....23		JOSEPH uncino mucosa70		LITTLER forbici delicate22	
GRAEFE forbici delicate.....22		Jost tritacartilagine.....133		LOCKWOOD strumento per	
GRAEFE pinza morsi dentellati.....41				marcare3	
Graefe pinze per iride.....52		K		LUBET-BARBON pinza per	
GRAEFE uncinetto acuto69		Kasdan divaricatore.....73		medicature117	
GRAEFE uncinetto smusso.....69		KAYE face lift forbici31		LUC pinza tagliente per il setto	
Graig pinza per il setto nasale119		Kaye forbici blefaroplastica.....32		nasale119	
Green pinze fissatrici.....56		Kelly forbici per dissezione19		Lucae pinze auricolari.....57	
GREENBERG-PAR forbici		KELLY pinze emostatiche.....51			
bleforaplastica32		KELLY RANKIN pinze emostatiche...61		M	
Guilen cannula di aspirazione109		KILLIAN CLAUS sgorbia132		MacCollum-Dingmann	
GUTHRIE uncinetto doppio acuto69		KILLIAN elevatore per setto103		separatori mammari.....83	
GUTHRIE uncinetto doppio smusso.....69		KILLIAN elevatore per setto104		Maliniac retrattore nasale87	
		Killian sgorbia130		MALTZ (COTTLE) raspa nasale135	
H		Killian specoli nasali.....113		Maltz raspa nasale134	
HAJEK sgorbia132		Killian specoli nasali.....114		Manici per lame bisturi.....7	
Hajek-Ballenger elevatore per		KILNER DOUGHTY		Manici per lame bisturi.....8	
setto104		abbassalingua143		Manici per lame bisturi.....9	
HALSEY portaghi91		KILNER DOUGHTY apribocca143		Manici per lame bisturi.....10	
HALSTED-Mosquito micro pinze.....60		KILNER forbici per dissezione19		Manici per lame bisturi.....12	
HALSTED-Mosquito pinze.....60		Kilner retrattore nasale88		Martelli100	
HARTMANN pinza per polipi		Klapp divaricatori72		Martello intranasale Quising100	
nasali117		KLEINERT-KUTZ uncinetto		Martello Mead.....100	
Hartmann pinze emostatiche.....59		acuto per pelle70		Martello metallico Cottle100	
Hartmann specoli nasali.....111		Knapp divaricatore.....86		Martello metallico Gerzog.....100	
Hartmann-Halle specoli nasali110		KNAPP forbici delicate.....21		Martello metallico Partsch.....100	
HEYMANN forbici nasali.....27		KNIGHT pinza per il setto118		Martinez-Kilner divaricatore.....89	
HEYMANN KNIGHT pinza nasale...118				MASING elevatore per periostio...102	
HOLZHEIMER divaricatori.....75				Masing-Neivert retrattore nasale87	
HOWARTH elevatore per setto103				MAYO forbici per dissezione.....13	
Humby dermatomo6				Mayo-HaberlSSER pinze torcifili...97	
HUMBY uncinetto doppio per pelle.....71				MAYO-Hegar portaghi92	
				MAYO-Stille forbici per dissezione.....14	
				MC INDOE cesoia per ossa99	

MC Indoe forbici gengivali	29	Osteotomo Obwegeser	131	Pinza per medicature Westmacott	117
McINDOE pinza 1x2 denti	42	osteotomo per setto nasale Freer	128	Pinza per polipi nasali	
MCINDOE pinza anatomica	42	osteotomo Rubin	129	HARTMANN	117
McIVOR abbassalingua	144	Osteotomo Tessier	151	pinza per raddrizzare il setto	
McIVOR apribocca completo	144	Optica per endoplastica	152	nasale Asch	140
McKENTY elevatore per setto	102			pinza per raddrizzare il setto	
McKENTY elevatore per setto	103	P		nasale Walsham	140
McKISSOCK, strumento per		Parkes raspa nasale	134	pinza sgorbia Beyer	98
marcare	4	PARTSCH martello metallico	100	Pinza sgorbia BOEHLER	98
MEAD martello	100	PECK-JOSEPH face lift forbici	31	pinza sgorbia Friedmann	98
METZENBAUM forbici per		Peet raspa nasale	134	pinza sgorbia mini Friedman	98
dissezione	16	PENNINGTON Elevatore per setto	103	pinza tagliente nasale	
METZENBAUM forbici per		Periostotomo Doppio Dingman	150	Weil-Blakesley	120
dissezione	17	Periostotomo Fomon	101	pinza tagliente per il setto	
MEYERDING divaricatori	74	Periostotomo Joseph	101	nasale Luc	119
Micro forbici	34	Periostotomo OBWEGSER	149	Pinza torcifili Berry	97
Micro forbici	35	PIERCE Elevatore per setto	103	Pinza USA 1x2 denti	37
Micro forbici	33	Pinza 1 x 2 denti Potts-Smith	36	Pinza USA p. dissezione	36
Micro pinze ad anello	48	Pinza 1x2 denti McIndoe	42	Pinze 1x2 denti Gillies	43
Micro pinze Halsted-Mosquito	60	Pinza 5x6 denti Lerche	41	pinze 1x2 denti Semken	43
Micro pinze per legature	47	pinza a baionetta Taylor	44	Pinze Adson, chirurgiche	39
micro portaghi Barraquer	95	pinza anatomica McIndoe	42	Pinze Adson,	
micro portaghi Castroviejo	96	Pinza anatomica Bonney	45	chirurgiche/anatomiche	38
MICROVASCULAR portaghi	93	pinza anatomica Cushing	41	Pinze Adson-Brown, chirurgiche	40
MIDDLETON JANSEN pinza		Pinza anatomica Potts-Smith	36	Pinze anatomiche Durante	45
per il setto nasale	123	Pinza auricolare Jansen-Gruenwald	57	pinze anatomiche Gerald	43
Miller divaricatore	86	Pinza auricolare Wilde (Troeltsch)	57	pinze anatomiche Semken	43
Mini-Lambotte osteotomo	132	pinza chirurgica 1x2 Gerald	43	Pinze anatomiche Stille	36
MINI-LANGENBECK Endo		Pinza chirurgica Cushing	41	Pinze atraumatiche DeBakey	50
dissettore	77	Pinza chirurgica Stille	37	Pinze atraumatiche DeBakey	51
MOELTGEN goniometro	2	pinza con cucchiaino, modello russo	42	Pinze auricolari Lucae	57
MYLES pinza nasale tagliente	121	Pinza depilatoria Barraquer	55	Pinze auricolari Troeltsch	57
		Pinza emostatica Adson	64	Pinze chirurgiche 2x3 denti	37
N		Pinza fenestrata Collin-Duval	42	Pinze chirurgiche 3x4 denti	37
Neivert-Anderson Osteotomo	130	Pinza fenestrata Duval	42	Pinze chirurgiche 4x5 denti	37
News gancio per tracheotomia	90	Pinza morsi dentellati Graefe	41	Pinze chirurgiche Brown	41
		Pinza nasale Heymann-Knight	118	Pinze chirurgiche Ferris-Smith	42
O		pinza nasale tagliente Myles	121	Pinze chirurgiche Gerald	44
O'BRIEN forbici taglia fili	28	pinza nasale tagliente Schmeden	121	Pinze chirurgiche Stille-Barraya	45
OBWEGESER divaricatore	146	pinza nasale tagliente Takahashi	121	Pinze chirurgiche Waugh	41
OBWEGESER divaricatore	147	Pinza p. diss. 1x2 denti	37	Pinze da presa per endoscopia	157
OBWEGESER divaricatore	148	pinza p. dissezione. micro	43	Pinze emostatiche Coller-Crile	61
OBWEGESER Osteotomo	131	Pinza per appiattamento setto		pinze emostatiche Crile	62
OBWEGESER periostotomo	149	nasale Rubin	122	Pinze emostatiche Crile-Rankin	62
OCHSNER pinza per dissezione	45	Pinza per columella Cottle	57	Pinze emostatiche Hartmann	59
O'Connor divaricatore	86	Pinza per dissezione Ochsner	45	Pinze emostatiche Kelly	61
OLSEN HEGAR portaghi	93	Pinza per il setto Knight	118	Pinze emostatiche Kelly-Rankin	61
osteotomo Cottle	129	pinza per il setto nasale Brünings	119	Pinze emostatiche Leriche	63
Osteotomo Mini-Lambotte	132	pinza per il setto nasale Graig	119	Pinze emostatiche	
Osteotomo nasale Silver	130	pinza per il setto nasale		Providence-Hospital	61
Osteotomo nasale West	132	Middleton Jansen	123	Pinze emostatiche	
Osteotomo Neivert-Anderson	130	Pinza per medicature Lubet-Baron	117	Rochester-Ochsner	63

Pinze emostatiche Rochester-Pean ..63	Raspa nasale Peet134	SILVER osteotomo nasale130
Pinze fissatrici Green.....56	raspa nasale Wiener.....134	SILVERSTEIN separatori mammari...83
Pinze Halsted-Mosquito.....60	REDA coltello falcato125	SINGLEY pinze per tessuti.....45
Pinze muscolari Berke.....55	Regolo metal.grad.mm/pollici2	Sinus elevatore per setto103
Pinze per calazio Desmarres.....55	Retratore nasale Freer88	Spatola.....80
Pinze per dissezione chirurgiche...37	Retratore nasale Kilner.....88	Spatole addominali Ribbon.....66
pinze per dissezione,	Retratore nasale Maliniac.....87	Spazzolino138
chirurgiche/anatomiche36	Retratore nasale Masing-Neivert.....87	Specoli nasali112
Pinze per iride Bishop-Harmann....53	Retrattori nasali Aufricht87	Specoli nasali Cottle115
Pinze per iride Graefe.....52	Retrattori nasali Converse87	Specoli nasali Cottle116
Pinze per schegge.....46	Retrattori nasali Cottle87	Specoli nasali Hartmann111
Pinze per sutura Castroviejo55	Retrattori nasali Cottle88	Specoli nasali Hartmann-Halle110
Pinze per sutura mod. Bonn54	Retrattori nasali Fomon88	Specoli nasali Killian113
Pinze per sutura mod. Tuebingen.....54	Retratore nasale Cottle-Neivert....88	Specoli nasali Killian114
Pinze per tessuti Singley45	REYNOLDS forbici per dissezione19	Specoli nasali Tieck-Halle112
Pinze torcifili Mayo-Haberisser97	RIBBON spatole addominali.....66	Specoli nasali, mod. Wien.....112
Pitanguy strumento per marcare3	ROCHESTER OCHSNER	SPENCER forbici taglia fili.....28
Placca per palpebre58	pinze emostatiche.....63	SPINA-NASALIS divaricatore148
Placca per stendipelle5	ROCHESTER PEAN pinze	STEVENS forbici delicate24
portaghi Baby Olsen-Hegar93	emostatiche63	STILLE pinza chirurgica.....37
Portaghi Baby-Webster.....91	ROUET divaricatore86	STILLE pinze anatomiche36
portaghi Baumgartner92	ROUX mini divaricat.doppio65	STILLE-BARRAYA pinze
Portaghi Crile-Wood92	RUBIN osteotomo129	chirurgiche45
portaghi DeBaKey92	RUBIN pinza per appiattamento	STRANDELL-STILLE divaricatori74
Portaghi Derf91	setto nasale122	Strumenti per labbra e palato105
Portaghi Halsey91	Russel-Davis abbassalingua145	Strumenti per labbra e palato Blair ...106
portaghi Mayo-Hegar92	RYDER portaghi93	strumento per marcare
Portaghi microvascular93	S	D'Assumpaco.....3
portaghi Olsen-Hegar93	SANVENERO forbici per	strumento per marcare Lockwood3
portaghi Ryder93	dissezione.....18	strumento per marcare McKissock ...4
portaghi tagliente Gillies94	scalpello per plastica nasale	strumento per marcare Pitanguy3
Portaghi Webster91	Cottle129	Strumento per marcare, Freemann4
POTTS SMITH pinze anatomiche36	Schink Dermatomo5	T
POTTS-SMITH pinza 1 x 2 denti36	SCHMEDEN pinza nasale	TAKAHASHI pinza nasale
Providence-Hospital pinze	tagliente121	tagliente121
emostatiche61	sega nasale angolata Joseph.....139	TAYLOR pinza a baionetta44
Q	sega nasale Joseph.....138	TAYLOR pinza anatomica44
QUISLING martello intranasale100	SEMKEN pinze 1x2 denti43	TAYLOR pinza chirurgica 1x2.....44
R	SEMKEN pinze anatomiche43	Tebbetts divaricatori.....78
RAGNEL divaricatore doppio.....65	Separatori mammari Agri-Dingman...82	TEBBETTS Separatori mammari.....83
RAMUS divaricatore148	Separatori mammari	Telaio solo per DAVIS BOYLE142
raspa nasal Dingman.....138	MacCollum-Dingmann83	Telaio solo per DAVIS MEYER144
raspa nasale Aufricht135	Separatori mammari Silverstein83	Telaio solo per DINGMANN143
raspa nasale doppia Fomon136	Separatori mammari Tebbetts.....83	Telaio solo per Kilner-Doughty.....143
raspa nasale doppia Fomon137	Sgorbia Freer.....132	Tessier divaricatore150
Raspa nasale Glabella134	Sgorbia Hajek.....132	TESSIER Osteotomo.....151
raspa nasale Joseph Lewis135	Sgorbia Killian.....130	TieCK HALLE specoli nasali112
raspa nasale Maltz134	Sgorbia Killian-Claus132	Tritacartilagine Cottle.....133
raspa nasale Maltz (Cottle).....135	Sgorbia nasale West132	Tritacartilagine Jost.....133
Raspa nasale Parkes134	Sgorbia periototomo Boies102	Troeltsch pinze auricolari.....57
	Silver dermatomo6	TYRELL uncinetto acuto.....69

U

Uncinetto acuto Frazier.....	70
Uncinetto acuto Graefe.....	69
uncinetto acuto per pelle	
Kleinert-Kutz	70
Uncinetto acuto Tyrell.....	69
Uncinetto doppio acuto Guthrie	69
Uncinetto doppio per pelle Humby.....	71
Uncinetto doppio smusso Guthrie.....	69
Uncinetto per pelle Barsky.....	71
Uncinetto smusso Frazier.....	70
Uncinetto smusso Graefe	69
Uncini per dura-madre Adson	85
Uncini per nervi Crile	85
Uncini per nervi Cushing	85
Uncini per nervi destra e sinistra	77
Uncini per pelle Anderson.....	79
Uncino mucosa Joseph	70

V

VOLKMANN divaricatori	73
-----------------------------	----

W

Wagner forbici delicate	25
WALSHAM pinza per raddrizzare il setto nasale.....	140
WALTER/CONVERSE/WILMER forbici delicate.....	22
Watson dermatomo	6
WAUGH pinze chirurgiche.....	41
WEBSTER portaghi.....	91
WEIL BLAKESLEY pinza tagliante nasale	120
WEITLANER divaricatori	76
WEST osteotomo nasale	132
WEST sgorbia nasale	132
WESTMACOTT pinza per medicature	117
WIEDER abbassalingua	141
Wiener divaricatori.....	86
WIENER raspa nasale.....	134
Wilde (Troeltsch) pinza auricolare	57
WILLIGER dissettori	101
WILMER/CONVERSE/WALTER forbici delicate.....	22

Y

YANCOSKIE divaricatori.....	79
-----------------------------	----

Weitere Kataloge und Prospekte
Other cataloges and prospects

Hauptkatalog Chirurgische Instrumente
General catalog surgical instruments

Arthroskopie
Arthroscopy

Container Steriltechnik
Container Sterilization Technique

Endoskopie
Endoscopy

HERCULES® Drahtkneifzange
HERCULES® Wire Cutters

Neurochirurgie
Neuro Surgery

Orthopädie
Orthopedic

Titan Instrumente
Titanium Instruments



INSTRUMENTE GMBH

Gänsäcker 34
P.O. Box 131
D-78532 Tuttlingen
Germany



Fon +49 7462.9445-0
Fax +49 7462.9445-20
info@Reda-Instrumente.de
www.Reda-Instrumente.de

